

VFD-VL

User Manual

Elevator Drive



Power Range :

3-phase 230V series: 5.5kW~22kW (7.5~30HP)
3-phase 460V series: 5.5kW~22kW (7.5~30HP)



DELTA ELECTRONICS, INC.

www.delta.com.tw/industrialautomation

ASIA

Delta Electronics, Inc.

Taoyuan1

31-1, Xingbang Road, Guishan Industrial Zone,
Taoyuan County 33370, Taiwan, R.O.C.
TEL: 886-3-362-6301 / FAX: 886-3-362-7267

Delta Electronics (Jiang Su) Ltd.

Wujiang Plant3

1688 Jiangxing East Road,
Wujiang Economy Development Zone,
Wujiang City, Jiang Su Province,
People's Republic of China (Post code: 215200)
TEL: 86-512-6340-3008 / FAX: 86-512-6340-7290

Delta Electronics (Japan), Inc.

Tokyo Office

Delta Shibadaimon Building, 2-1-14 Shibadaimon,
Minato-Ku, Tokyo, 105-0012, Japan
TEL: 81-3-5733-1111 / FAX: 81-3-5733-1211

Delta Electronics (Korea), Inc.

234-9, Duck Soo BD 7F, Nonhyun-dong,
Kangnam-ku, Seoul, Korea
Post code : 135-010
TEL: 82-2-515-5303/5 / FAX: 82-2-515-5302

Delta Electronics (Singapore) Pte. Ltd.

8 Kaki Bukit Road 2, #04-18 Ruby Warehouse Complex,
Singapore 417841
TEL: 65-6747-5155 / FAX: 65-6744-9228

Delta Energy Systems (India) Pvt. Ltd.

Plot No. 27 & 31, Sector-34, EHTP,
Gurgaon-122001 Haryana, India
TEL: 91-124-4169040 / FAX: 91-124-4036045

AMERICA

Delta Products Corporation (USA)

Raleigh Office

P.O. Box 12173, 5101 Davis Drive,
Research Triangle Park, NC 27709, U.S.A.
TEL: 1-919-767-3813 / FAX: 1-919-767-3969

EUROPE

Deltronics (Netherlands) B.V.

Eindhoven Office

De Witbogt 15, 5652 AG Eindhoven, The Netherlands
TEL: 31-40-259-28-50/ FAX: 31-40-259-28-51

5011663904
201110-18



VLE4



VFD-VL

User Manual

Elevator Drive

Thank you for choosing DELTA's high-performance VFD-VL Series. The VFD-VL Series is manufactured with high-quality components and materials and incorporates the latest microprocessor technology available.

This manual is to be used for the installation, parameter setting, troubleshooting, and daily maintenance of the AC motor drive. To guarantee safe operation of the equipment, read the following safety guidelines before connecting power to the AC motor drive. Keep this operating manual at hand and distribute to all users for reference.

To ensure the safety of operators and equipment, only qualified personnel familiar with AC motor drive are to do installation, start-up and maintenance. Always read this manual thoroughly before using VFD-VL series AC Motor Drive, especially the WARNING, DANGER and CAUTION notes. Failure to comply may result in personal injury and equipment damage. If you have any question, please contact your dealer.

PLEASE READ PRIOR TO INSTALLATION FOR SAFETY.



DANGER!

-
1. AC input power must be disconnected before any wiring to the AC motor drive is made.
 2. A charge may still remain in the DC-link capacitors with hazardous voltages, even if the power has been turned off. To prevent personal injury, please ensure that power has turned off before opening the AC motor drive and wait ten minutes for the capacitors to discharge to safe voltage levels.
 3. Never reassemble internal components or wiring.
 4. The AC motor drive may be destroyed beyond repair if incorrect cables are connected to the input/output terminals. Never connect the AC motor drive output terminals U/T1, V/T2, and W/T3 directly to the AC mains circuit power supply.
 5. Ground the VFD-VL using the ground terminal. The grounding method must comply with the laws of the country where the AC motor drive is to be installed. Refer to the Basic Wiring Diagram.
 6. VFD-VL series is used only to control variable speed of 3-phase induction motors, NOT for 1-phase motors or other purpose.
 7. VFD-VL series shall NOT be used for life support equipment or any life safety situation.

**WARNING!**

1. DO NOT use Hi-pot test for internal components. The semi-conductor used in AC motor drive easily damage by high-voltage.
2. There are highly sensitive MOS components on the printed circuit boards. These components are especially sensitive to static electricity. To prevent damage to these components, do not touch these components or the circuit boards with metal objects or your bare hands.
3. Only qualified persons are allowed to install, wire and maintain AC motor drives.

**CAUTION!**

1. Some parameters settings can cause the motor to run immediately after applying power.
2. DO NOT install the AC motor drive in a place subjected to high temperature, direct sunlight, high humidity, excessive vibration, corrosive gases or liquids, or airborne dust or metallic particles.
3. Only use AC motor drives within specification. Failure to comply may result in fire, explosion or electric shock.
4. To prevent personal injury, please keep children and unqualified people away from the equipment.
5. When the motor cable between AC motor drive and motor is too long, the layer insulation of the motor may be damaged. Please use a frequency inverter duty motor or add an AC output reactor to prevent damage to the motor. Refer to appendix B Reactor for details.
6. The rated voltage for AC motor drive must be $\leq 240V$ ($\leq 480V$ for 460V models) and the mains supply current capacity must be $\leq 5000A$ RMS ($\leq 10000A$ RMS for the $\geq 40hp$ (30kW) models)

Table of Contents

Preface	i
Table of Contents	iii
Chapter 1 Introduction	1-1
1.1 Receiving and Inspection	1-2
1.1.1 Nameplate Information.....	1-2
1.1.2 Model Explanation	1-2
1.1.3 Series Number Explanation	1-3
1.1.4 Drive Frames and Appearances	1-3
1.1.5 Drive Features	1-5
1.2 Preparation for Installation and Wiring	1-6
1.2.1 Ambient Conditions.....	1-6
1.2.2 Remove Front Cover.....	1-7
1.2.3 Lifting	1-8
1.2.4 Flange Mounting	1-9
1.2.5 Cutout Dimensions.....	1-11
1.3 Dimensions.....	1-13
Chapter 2 Installation and Wiring	2-1
2.1 Wiring	2-2
2.2 External Wiring	2-7
2.3 Main Circuit	2-8

2.3.1 Main Circuit Connection	2-8
2.3.2 Main Circuit Terminals.....	2-10
2.4 Control Terminals	2-11
Chapter 3 Operation and Start Up	3-1
3.1 Operation Method	3-2
3.2 Trial Run	3-3
3.3 Auto-tuning Operations.....	3-4
3.3.1 Flow Chart.....	3-4
3.3.2 Explanations for the Auto-tuning Steps	3-5
3.3.2.1 Step 1	3-5
3.3.2.2 Step 2	3-7
3.3.2.3 Step 3	3-8
3.3.2.4 Step 4	3-12
3.3.2.5 Step 5	3-13
3.3.2.6 Step 6	3-14
3.3.2.7 Step 7	3-14
Chapter 4 Parameters.....	4-1
4.1 Summary of Parameter Settings.....	4-2
4.1.1 Group 0 System Parameters	4-2
4.1.2 Group 1 Basic Parameters	4-4
4.1.3 Group 2 Digital Input/Output Parameters	4-5
4.1.4 Group 3 Analog Input/Output Parameters	4-7
4.1.5 Group 4 Multi-Step Speed Parameters	4-9
4.1.6 Group 5 IM Parameters.....	4-10
4.1.7 Group 6 Protection Parameters.....	4-11

4.1.8 Group 7 Special Parameters.....	4-14
4.1.9 Group 8 PM Parameters.....	4-15
4.1.10 Group 9 Communication Parameters.....	4-16
4.1.11 Group 10 Speed Feedback Control Parameters.....	4-17
4.1.12 Group 11 Advanced Parameters.....	4-19
4.1.13 Group 12 User-defined Parameters.....	4-20
4.1.14 Group 13 View User-defined Parameters.....	4-21
4.2 Description of Parameter Settings.....	4-22
4.2.1 Group 0 User Parameters.....	4-22
4.2.2 Group 1 Basic Parameters.....	4-32
4.2.3 Group 2 Digital Input/Output Parameters.....	4-39
4.2.4 Group 3 Analog Input/Output Parameters.....	4-55
4.2.5 Group 4 Multi-Step Speed Parameters.....	4-61
4.2.6 Group 5 IM Parameters.....	4-62
4.2.7 Group 6 Protection Parameters.....	4-67
4.2.8 Group 7 Special Parameters.....	4-84
4.2.9 Group 8 PM Parameters.....	4-91
4.2.10 Group 9: Communication Parameters.....	4-95
4.2.11 Group 10 Speed Feedback Control Parameters.....	4-106
4.2.12 Group 11 Advanced Parameters.....	4-114
4.2.13 Group 12 User-defined Parameters.....	4-119
4.2.14 Group 13 View User-defined Parameters.....	4-127

Chapter 5 Troubleshooting..... 5-1

5.1 Over Current (OC).....	5-1
----------------------------	-----

5.2 Ground Fault.....	5-2
5.3 Over Voltage (OV)	5-2
5.4 Low Voltage (Lv).....	5-3
5.5 Over Heat (OH).....	5-4
5.6 Overload	5-4
5.7 Display of KPVL-CC01 is Abnormal.....	5-5
5.8 Phase Loss (PHL).....	5-5
5.9 Motor cannot Run	5-6
5.10 Motor Speed cannot be Changed	5-7
5.11 Motor Stalls during Acceleration	5-8
5.12 The Motor does not Run as Expected	5-8
5.13 Electromagnetic/Induction Noise	5-9
5.14 Environmental Condition.....	5-9
5.15 Affecting Other Machines.....	5-10
Chapter 6 Fault Code Information	6-1
6.1 Fault Code Information	6-1
6.1.1 Common Problems and Solutions	6-2
6.1.2 Reset.....	6-9
Appendix A Specifications.....	A-1
Appendix B Accessories.....	B-1
B.1 All Brake Resistors & Brake Units Used in AC Motor Drives	B-2
B.1.1 Dimensions and Weights for Brake Resistors	B-5
B.1.1 Dimensions and Weights for Brake Resistors	B-5
B.1.2 Specifications for Brake Unit.....	B-7
B.1.3 Dimensions for Brake Unit	B-8

B.2 Non-fuse Circuit Breaker Chart	B-9
B.3 Fuse Specification Chart	B-9
B.4 AC Reactor	B-11
B.4.1 AC Input Reactor Recommended Value.....	B-11
B.4.2 AC Output Reactor Recommended Value.....	B-11
B.4.3 Applications for AC Reactor.....	B-12
B.5 Zero Phase Reactor (RF220X00A)	B-14
B.6 DC Choke Recommended Values	B-15
B.7 Digital Keypad KPVL-CC01	B-16
B.7.1 Description of the Digital Keypad KPVL-CC01	B-16
B.7.2 How to Operate the Digital Keypad KPVL-CC01	B-18
B.7.3 Dimension of the Digital Keypad.....	B-20
B.7.4 Recommended Position the Rubber Magnet of the Digital Keypad	B-20
B.8 PG Card (for Encoder)	B-21
B.8.1 EMVL-PGABL.....	B-21
B.8.2 EMVL-PGABO.....	B-24
B.8.3 EMVL-PGH01 (only for Heidenhain ERN1387)	B-31
B.8.4 EMVL-PGS01	B-35
B.9 AMD-EMI Filter Cross Reference.....	B-38
B.10 EMVL-IOA01	B-41
B.11 Safety Relay EMVL-SAF01	B-42
B.11.1 Functions of the Terminals	B-42
B.11.2 Wiring of the Safety Relay	B-42

Appendix C How to Select the Right AC Motor Drive	C-1
C.1 Capacity Formulas	C-2
C.2 General Precaution	C-4
C.3 How to Choose a Suitable Motor	C-5
Appendix D Suggestions and Error Corrections for Standard AC Motor Drives	D-21
D.1 Maintenance and Inspections	D-2
D.2 Greasy Dirt Problem	D-7
D.3 Fiber Dust Problem	D-8
D.4 Erosion Problem	D-9
D.5 Industrial Dust Problem	D-10
D.6 Wiring and Installation Problem	D-11
D.7 Multi-function Input/Output Terminals Problem	D-12

Chapter 1 Introduction

The AC motor drive should be kept in the shipping carton or crate before installation. In order to retain the warranty coverage, the AC motor drive should be stored properly when it is not to be used for an extended period of time. Storage conditions are:



CAUTION!

1. Store in a clean and dry location free from direct sunlight or corrosive fumes.
2. Store within an ambient temperature range of -20°C to $+60^{\circ}\text{C}$.
3. Store within a relative humidity range of 0% to 90% and non-condensing environment.
4. Store within an air pressure range of 86 kPA to 106kPA.
5. DO NOT place on the ground directly. It should be stored properly. Moreover, if the surrounding environment is humid, you should put exsiccator in the package.
6. DO NOT store in an area with rapid changes in temperature. It may cause condensation and frost.
7. If the AC motor drive is stored for more than 3 months, the temperature should not be higher than 30°C . Storage longer than one year is not recommended, it could result in the degradation of the electrolytic capacitors.
8. When the AC motor drive is not used for longer time after installation on building sites or places with humidity and dust, it's best to move the AC motor drive to an environment as stated above.

The VFD-VL is able to control Induction Motors (IM) and Permanent Magnet Motors (PM).
In the manual throughout the abbreviations IM and PM are used.

1.1 Receiving and Inspection

This VFD-VL AC motor drive has gone through rigorous quality control tests at the factory before shipment. After receiving the AC motor drive, please check for the following:

- Check to make sure that the package includes an AC motor drive, the User Manual/Quick Start and CD.
- Inspect the unit to assure it was not damaged during shipment.
- Make sure that the part number indicated on the nameplate corresponds with the part number of your order.

1.1.1 Nameplate Information

Example for 15HP/11kW 230V 3-Phase AC motor drive

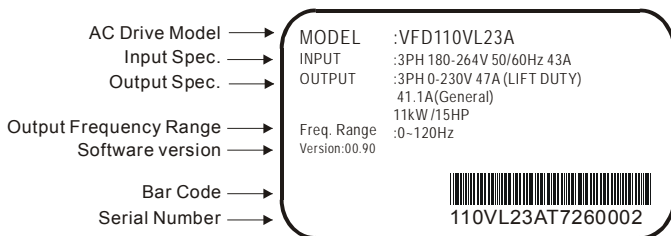

1.1.2 Model Explanation

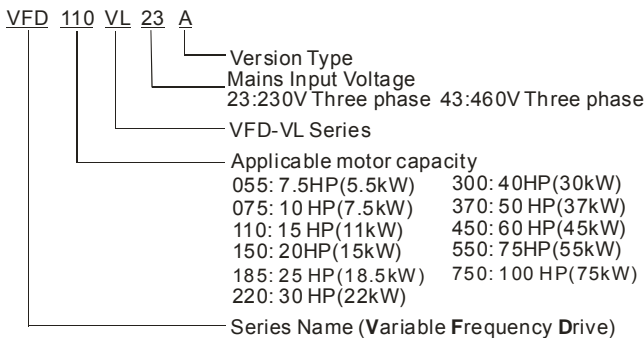

1.1.3 Series Number Explanation

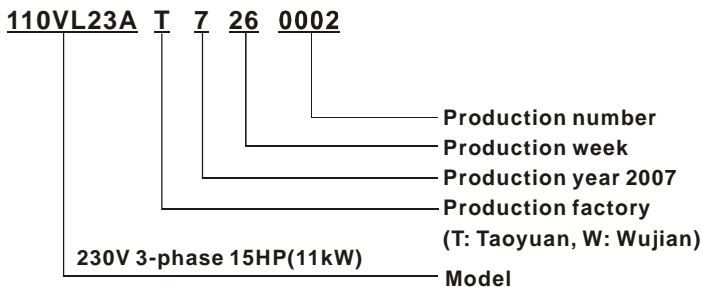

If the nameplate information does not correspond to your purchase order or if there are any problems, please contact your distributor.

1.1.4 Drive Frames and Appearances

7.5-15HP/5.5-11kW(Frame C)



20-30HP/15-22kW(Frame D)



40-100HP/30-75kW(Frame E)



Frame	Power range	Models
C	7.5-15HP (5.5-11kW)	VFD055VL23A/43A, VFD075VL23A/43A, VFD110VL23A/43A
D	20-30HP (15-22kW)	VFD150VL23A/43A, VFD185VL23A/43A, VFD220VL23A/43A
E (E1)	40-60hp (30-45kW)	VFD300VL43A, VFD370VL43A, VFD450V43A
E (E2)	40-100hp (30-75kW)	VFD300VL23A, VFD370VL23A, VFD550VL43A, VFD750VL43A

Please refer to Chapter 1.3 for exact dimensions.

1.1.5 Drive Features

Communication Port



Internal structure



Removable fan



1.2 Preparation for Installation and Wiring

1.2.1 Ambient Conditions

Install the AC motor drive in an environment with the following conditions:

Operation	Air Temperature:	-10 ~ +45°C (14 ~ 113°F)
	Relative Humidity:	<90%, no condensation allowed
	Atmosphere pressure:	86 ~ 106 kPa
	Installation Site Altitude:	<1000m
	Vibration:	<20Hz: 9.80 m/s ² (1G) max 20 ~ 50Hz: 5.88 m/s ² (0.6G) max
Storage Transportation	Temperature:	-20°C ~ +60°C (-4°F ~ 140°F)
	Relative Humidity:	<90%, no condensation allowed
	Atmosphere pressure:	86 ~ 106 kPa
	Vibration:	<20Hz: 9.80 m/s ² (1G) max 20 ~ 50Hz: 5.88 m/s ² (0.6G) max
Pollution Degree	2: good for a factory type environment.	

Minimum Mounting Clearances

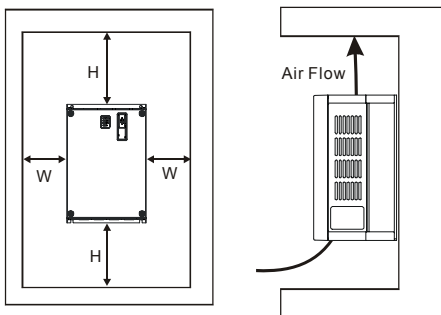

HP	W mm (inch)	H mm (inch)
7.5-20HP	75 (3)	175 (7)
25-75HP	75 (3)	200 (8)
100HP	75 (3)	250 (10)

**CAUTION!**

1. Operating, storing or transporting the AC motor drive outside these conditions may cause damage to the AC motor drive.
2. Failure to observe these precautions may void the warranty!
3. Mount the AC motor drive vertically on a flat vertical surface object by screws. Other directions are not allowed.
4. The AC motor drive will generate heat during operation. Allow sufficient space around the unit for heat dissipation.
5. The heat sink temperature may rise to 90°C when running. The material on which the AC motor drive is mounted must be noncombustible and be able to withstand this high temperature.
6. When AC motor drive is installed in a confined space (e.g. cabinet), the surrounding temperature must be within 10 ~ 40°C with good ventilation. DO NOT install the AC motor drive in a space with bad ventilation.
7. Prevent fiber particles, scraps of paper, saw dust, metal particles, etc. from adhering to the heatsink.
8. When installing multiple AC more drives in the same cabinet, they should be adjacent in a row with enough space in-between. When installing one AC motor drive below another one, use a metal separation between the AC motor drives to prevent mutual heating.

1.2.2 Remove Front Cover

7.5-15HP/5.5-11kW(frame C) & 20-30HP/15-22kW(frame D)

After removing the screws, please push the front cover to open it. For the open cover direction, please refer to the following picture.



40-100HP/30-75kW (frame E)

After removing the screws, please push the front cover to open it. For the open cover direction, please refer to the following picture.



1.2.3 Lifting

Please carry only fully assembled AC motor drives as shown in the following.

For 40-100HP (Frame E)

Step 1

Step 2

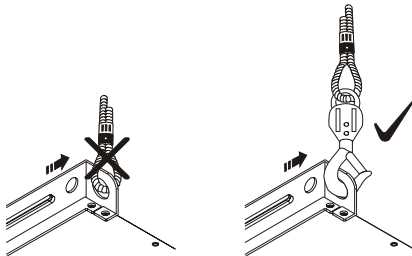
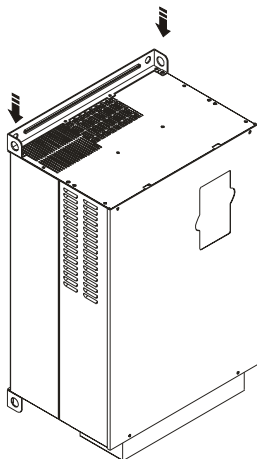

Step 3

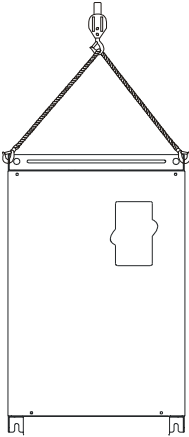

Step 4

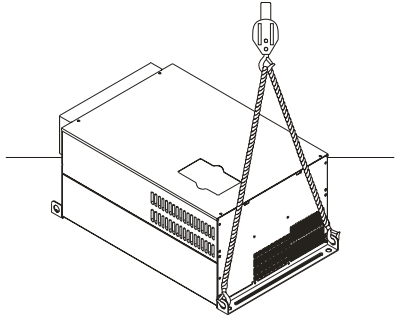

1.2.4 Flange Mounting

Step 1: Please take out the 16 screws (8 screws for each top and bottom side of the drive) and remove the fixed plate 1 and fixed plate 2 as shown in the following figures.

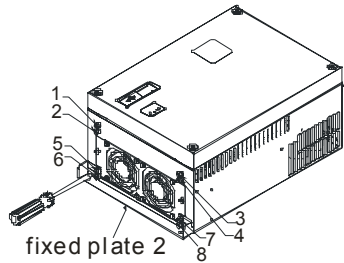
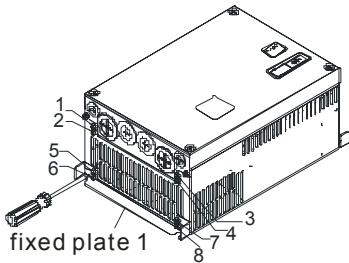

Step 2: place the 8 screws back in to secure the fixed plate 1 and fixed plate 2 (as shown in the following figures) with the following torque.

Frame C: 14-17kgf-cm [12.2-14.8in-lbf]

Frame D: 20-25kgf-cm [17.4-21.7in-lbf]

Frame E: 20-25kgf-cm [17.4-21.7in-lbf]

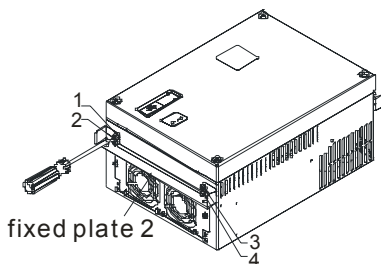
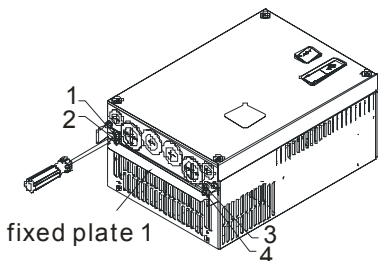

Step 3: Please notice that it doesn't need to put those 8 screws shown in the following figures back to the drive. Moreover, please make sure that these 2 different fixed plates are put in the correct side as shown in the figures.

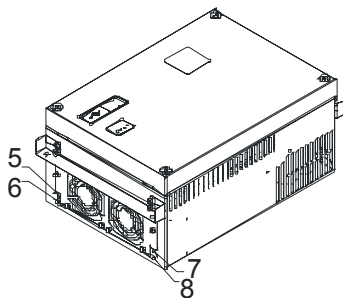
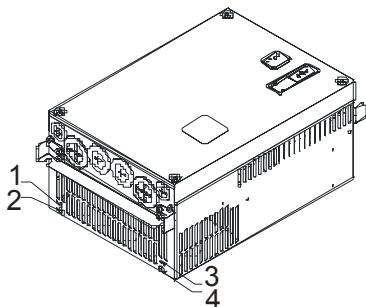

1.2.5 Cutout Dimensions

7.5-15HP/5.5-11kW (frame C)

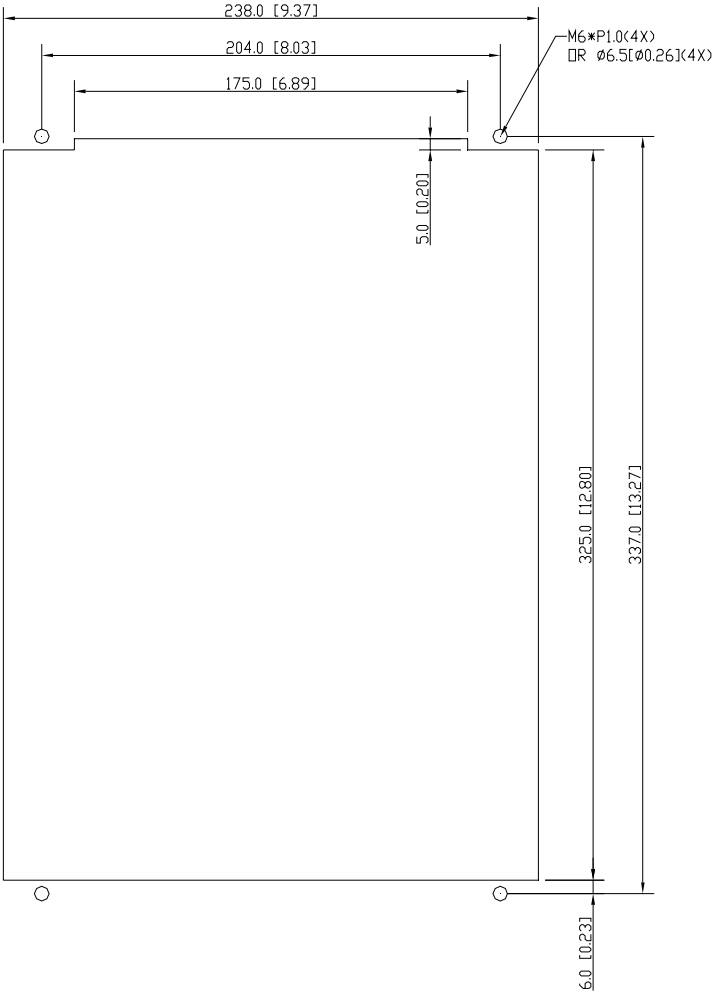

20-30HP/15-22kW (frame D)

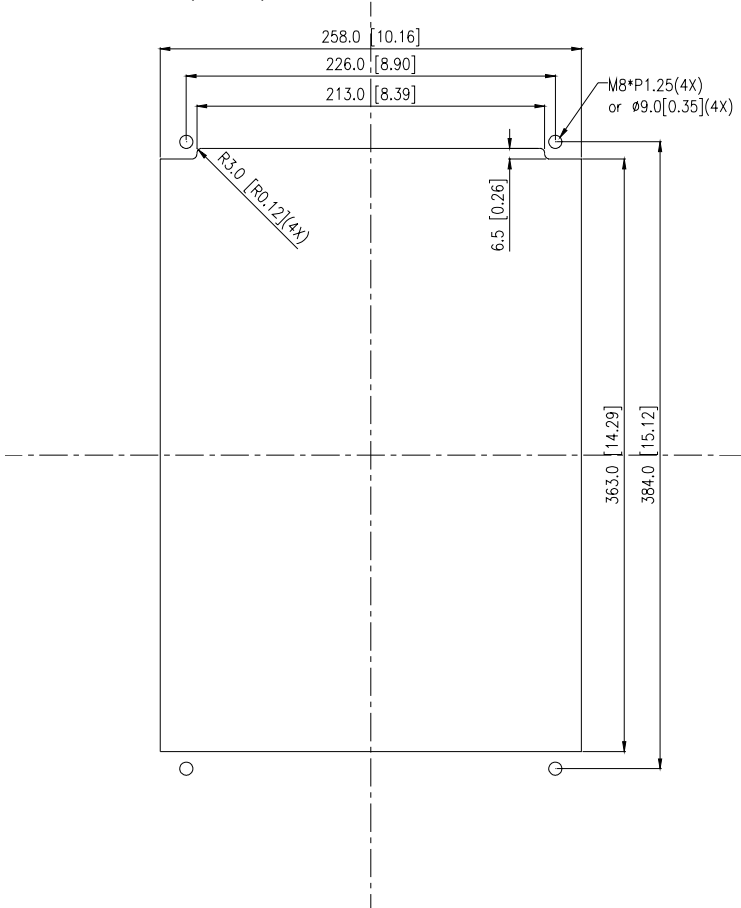

1.3 Dimensions

Frame C

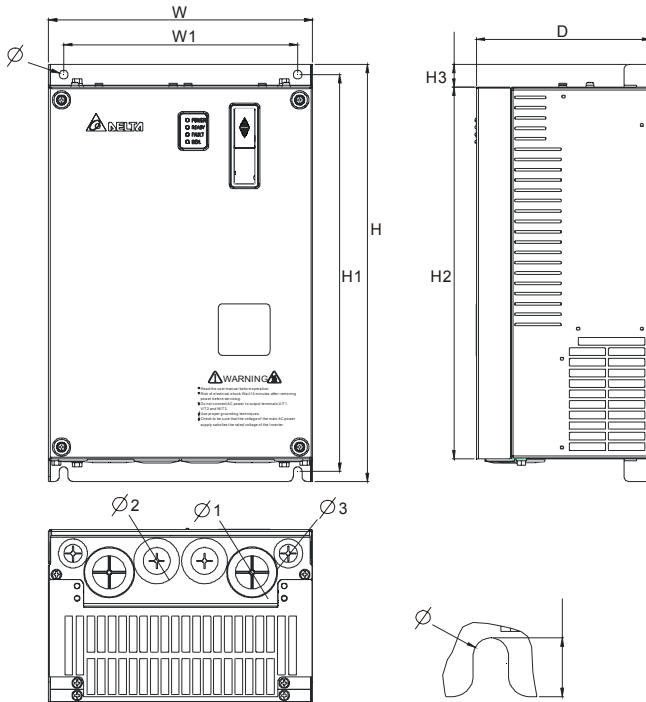

Unit: mm [inch]

Frame	W	W1	H	H1	H2	H3	D	Ø	Ø1	Ø2	Ø3
C	235 [9.25]	204 [8.03]	350 [13.78]	337 [13.27]	320 [12.60]	-	136 [5.35]	6.5 [0.26]	-	34 [1.34]	22 [0.87]



Frame C: VFD055VL23A/43A, VFD075VL23A/43A, VFD110VL23A/43A

Frame D

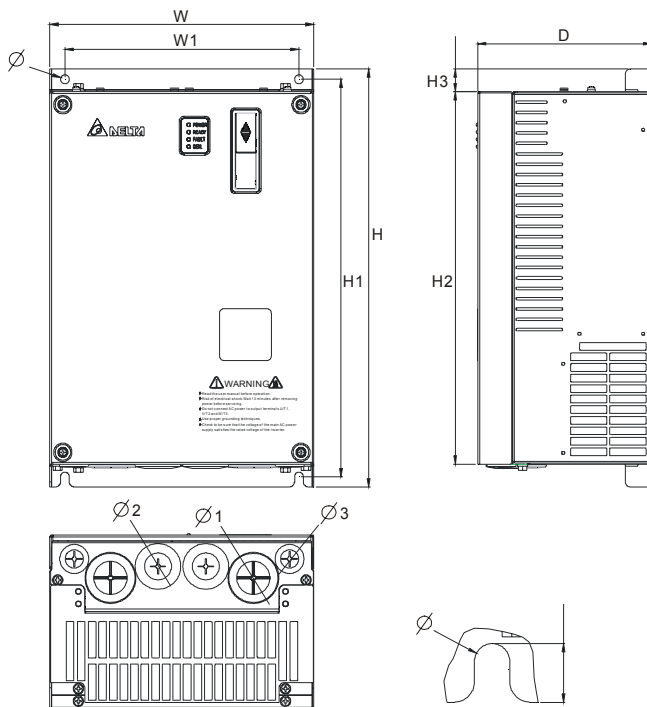

Unit: mm [inch]

Frame	W	W1	H	H1	H2	H3	D	Ø	Ø1	Ø2	Ø3
D	255.0 [10.04]	226.0 [8.90]	403.8 [15.90]	384.0 [15.12]	360.0 [14.17]	21.9 [0.86]	168.0 [6.61]	8.5 [0.33]	44 [1.73]	34 [1.34]	22 [0.87]



Frame D: VFD150VL23A/43A, VFD185VL23A/43A, VFD220VL23A/43A

Frame E

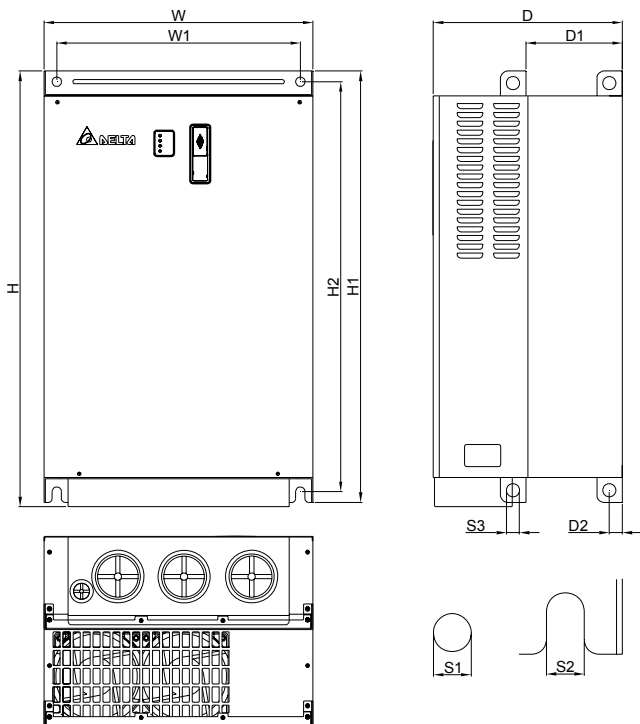

Unit: mm [inch]

Frame	W	W1	H	H1	H2	D	D1	D2	S1	S2	S3
E1	370.0 [14.57]	335.0 [13.19]	-	589.0 [23.19]	560.0 [22.05]	260.0 [10.24]	132.5 [5.22]	18.0 [0.71]	13.0 [0.51]	13.0 [0.51]	18.0 [0.71]
E2	370.0 [14.57]	335.0 [13.19]	595.0 [23.43]	589.0 [23.19]	560.0 [22.05]	260.0 [10.24]	132.5 [5.22]	18.0 [0.71]	13.0 [0.51]	13.0 [0.51]	18.0 [0.71]



Frame E1: VFD300VL43A, VFD370VL43A, VFD450VL43A

Frame E2: VFD300VL23A, VFD370VL23A, VFD550VL43A, VFD750VL43A

This page intentionally left blank

Chapter 2 Installation and Wiring

After removing the front cover (see chapter 1.2.2 for details), check if the power and control terminals are clear. Be sure to observe the following precautions when wiring.



CAUTION!

1. Make sure that power is only applied to the R/L1, S/L2, T/L3 terminals. Failure to comply may result in damage to the equipment. The voltage and current should lie within the range as indicated on the nameplate.
2. Check the following items after finishing the wiring:
 - A. Are all connections correct?
 - B. No loose wires?
 - C. No short-circuits between terminals or to ground?



DANGER!

1. A charge may still remain in the DC bus capacitors with hazardous voltages even if the power has been turned off. To prevent personal injury, please ensure that the power is turned off and wait ten minutes for the capacitors to discharge to safe voltage levels before opening the AC motor drive.
2. All the units must be grounded directly to a common ground terminal to prevent lightning strike or electric shock.
3. Only qualified personnel familiar with AC motor drives is allowed to perform installation, wiring and commissioning.
4. Make sure that the power is off before doing any wiring to prevent electric shock.

2.1 Wiring

Users must connect wires according to the circuit diagrams on the following pages. Do not plug a modem or telephone line to the RS-485 communication port, permanent damage may result. Pins 1 & 2 are the power supply for the optional copy keypad only and should not be used for RS-485 communication.

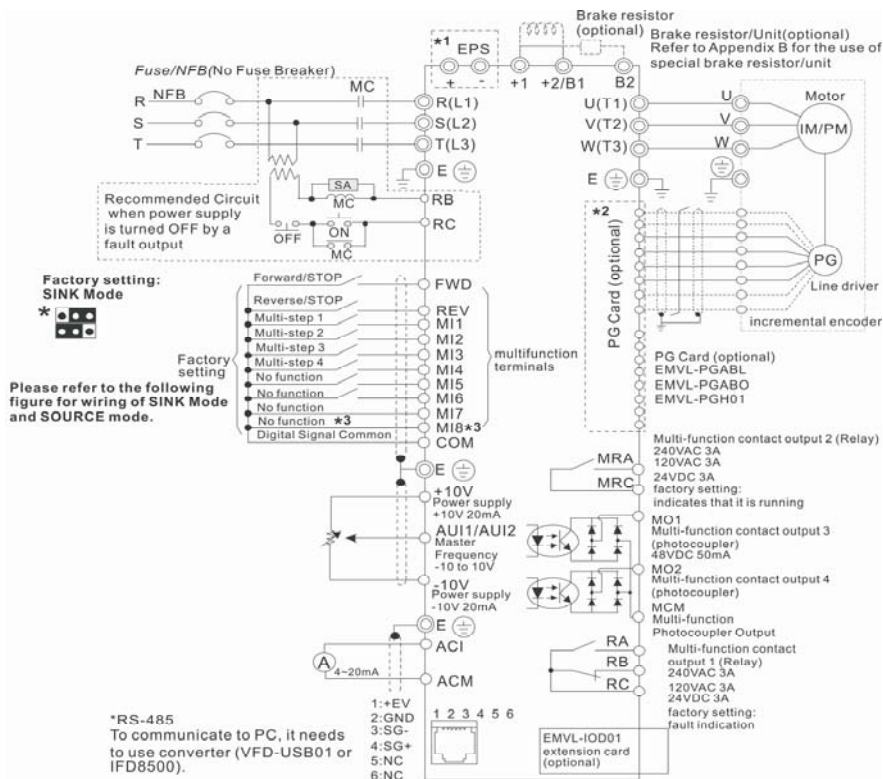

*1 Terminal EPS is emergency power input terminal, refer to the following figure for details.

*2 For PG card, refer to Appendix B for details.

*3 When JP1 on the control board is inserted, MI8 functions acc. to Pr02-08.
When JP1 on the control board is removed, MI8 is always "enable", independent of Pr02-08.

⊙ Main circuit (power) terminals ○ Control circuit terminals ⊞ Shielded leads & Cable

Figure 2 Wiring/Terminals setting for SINK(NPN) mode and SOURCE(PNP) mode

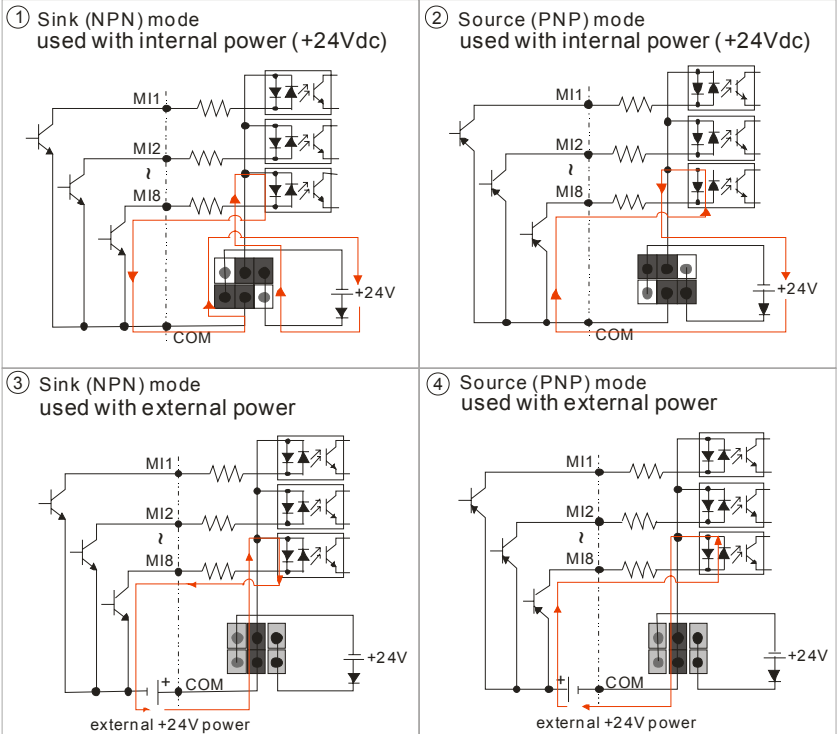

Figure 3 Apply to 1-phase UPS power supply system

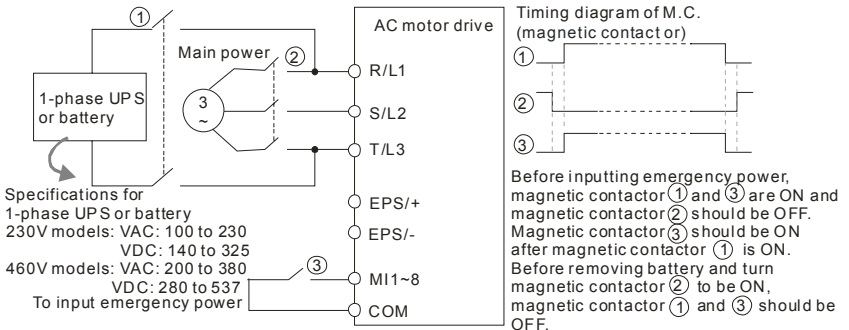
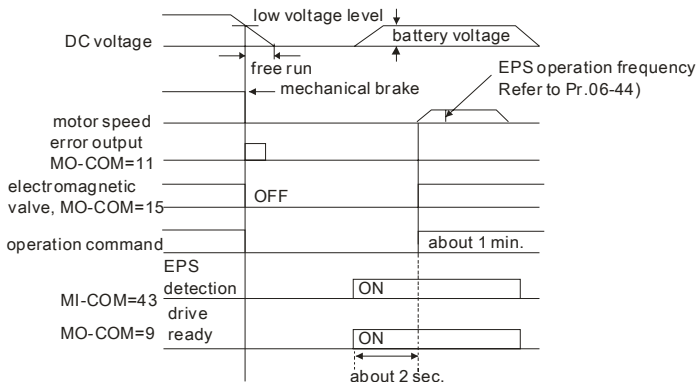
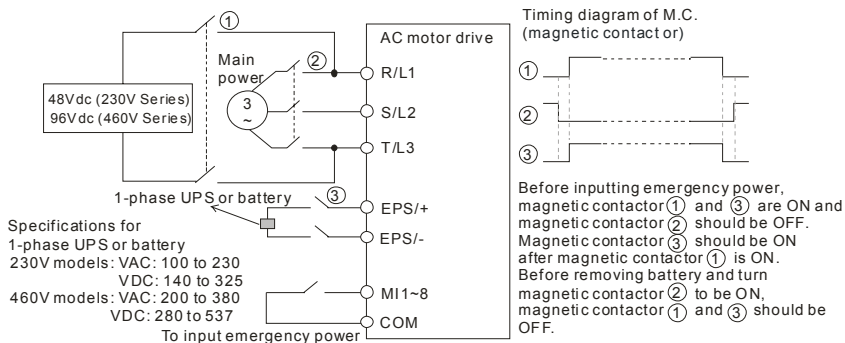

Figure 4 Apply to two batteries with main battery voltage is lower than 280Vdc



Notes for the emergency power supply. Please be aware of the following condition when emergency power is ON:

1. Fan doesn't run
2. Parameter setting will not be saved, when the power is turned off and applies again, the parameter setting will be gone.
3. Operate by the speed set in Pr.06-48.
4. No protections for low voltage and phase loss
5. Display DC-BUS voltage by Pr.06-29



1. The wiring of main circuit and control circuit should be separated to prevent erroneous actions.
2. Please use shield wire for the control wiring and not to expose the peeled-off net in front of the terminal.
3. Please use the shield wire or tube for the power wiring and ground the two ends of the shield wire or tube.
4. Damaged insulation of wiring may cause personal injury or damage to circuits/equipment if it comes in contact with high voltage.
5. The AC motor drive, motor and wiring may cause interference. To prevent the equipment damage, please take care of the erroneous actions of the surrounding sensors and the equipment.
6. When the AC drive output terminals U/T1, V/T2, and W/T3 are connected to the motor terminals U/T1, V/T2, and W/T3, respectively. To permanently reverse the direction of motor rotation, switch over any of the two motor leads.
7. With long motor cables, high capacitive switching current peaks can cause over-current, high leakage current or lower current readout accuracy. For longer motor cables use an AC output reactor.
8. The AC motor drive, electric welding machine and the greater horsepower motor should be grounded separately.
9. Use ground leads that comply with local regulations and keep them as short as possible.
10. No brake resistor is built in the VFD-VL series, it can install brake resistor for those occasions that use higher load inertia or frequent start/stop. Refer to Appendix B for details.
11. Multiple VFD-VL units can be installed in one location. All the units should be grounded directly to a common ground terminal, as shown in the figure below. **Ensure there are no ground loops.**

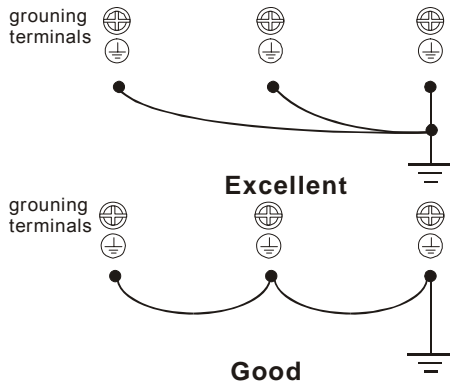

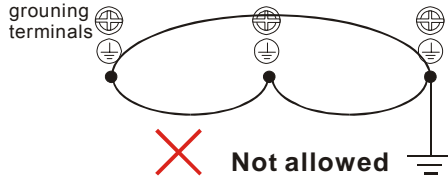

2.2 External Wiring

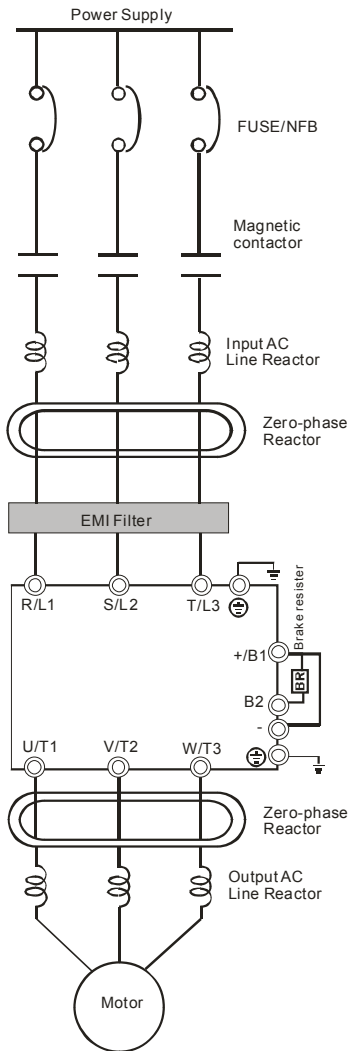

Items	Explanations
Power supply	Please follow the specific power supply requirements shown in Appendix A.
Fuse/NFB (Optional)	There may be an inrush current during power up. Please check the chart of Appendix B and select the correct fuse with rated current. Use of an NFB is optional.
Magnetic contactor (Optional)	Please do not use a Magnetic contactor as the I/O switch of the AC motor drive, as it will reduce the operating life cycle of the AC drive.
Input AC Line Reactor (Optional)	Used to improve the input power factor, to reduce harmonics and provide protection from AC line disturbances (surges, switching spikes, short interruptions, etc.). AC line reactor should be installed when the power supply capacity is 500kVA or more and exceeds 6 times the inverter capacity, or the mains wiring distance $\leq 10\text{m}$.
Zero-phase Reactor (Ferrite Core Common Choke) (Optional)	Zero phase reactors are used to reduce radio noise especially when audio equipment is installed near the inverter. Effective for noise reduction on both the input and output sides. Attenuation quality is good for a wide range from AM band to 10MHz. Appendix B specifies the zero phase reactor. (RF220X00A)
EMI filter (Optional)	To reduce electromagnetic interference, please refer to Appendix B for more details.
Brake Resistor (Optional)	Used to reduce the deceleration time of the motor. Please refer to the chart in Appendix B for specific Brake Resistors.
Output AC Line Reactor (Optional)	Motor surge voltage amplitude depends on motor cable length. For applications with long motor cable ($>20\text{m}$), it is necessary to install a reactor at the inverter output side.

2.3 Main Circuit

2.3.1 Main Circuit Connection

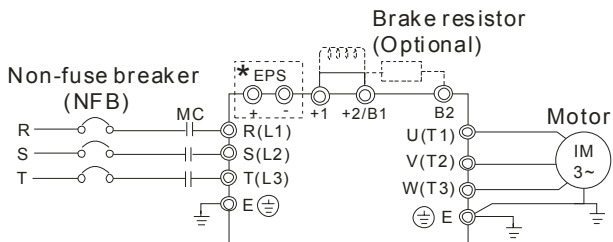

Terminal Symbol	Explanation of Terminal Function
EPS (+, -)	For emergency power or backup power supply
R/L1, S/L2, T/L3	AC line input terminals
U/T1, V/T2, W/T3	AC drive output terminals for connecting 3-phase induction motor
+1, +2/B1	Connections for DC Choke (optional). Please remove jumper when installation. (It is built in DC choke for models 22kW and above)
+2/B1, B2	Connections for Brake Resistor (optional)
	Earth connection, please comply with local regulations.

Mains power terminals (R/L1, S/L2, T/L3)

- Connect these terminals (R/L1, S/L2, T/L3) via a non-fuse breaker or earth leakage breaker to 3-phase AC power (some models to 1-phase AC power) for circuit protection. It is unnecessary to consider phase-sequence.
- It is recommended to add a magnetic contactor (MC) in the power input wiring to cut off power quickly and reduce malfunction when activating the protection function of AC motor drives. Both ends of the MC should have an R-C surge absorber.
- Please make sure to fasten the screw of the main circuit terminals to prevent sparks which is made by the loose screws due to vibration.
- Please use voltage and current within the regulation shown in Appendix A.
- When using a general GFCI (Ground Fault Circuit Interrupter), select a current sensor with sensitivity of 200mA or above, and not less than 0.1-second operation

time to avoid nuisance tripping. For the specific GFCI of the AC motor drive, please select a current sensor with sensitivity of 30mA or above.

- Do NOT run/stop AC motor drives by turning the power ON/OFF. Run/stop AC motor drives by RUN/STOP command via control terminals or keypad. If you still need to run/stop AC drives by turning power ON/OFF, it is recommended to do so only ONCE per hour.
- Do NOT connect 3-phase models to a 1-phase power source.

Output terminals for main circuit (U, V, W)

- When it needs to install the filter at the output side of terminals U/T1, V/T2, W/T3 on the AC motor drive. Please use inductance filter. Do not use phase-compensation capacitors or L-C (Inductance-Capacitance) or R-C (Resistance-Capacitance), unless approved by Delta.
- DO NOT connect phase-compensation capacitors or surge absorbers at the output terminals of AC motor drives.
- Use well-insulated motor, suitable for inverter operation.

Terminals [+1, +2] for connecting DC reactor, terminals [+1, +2/B1] for connecting brake resistor

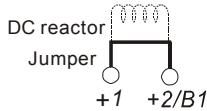

- To improve power factor and reduce harmonics connect a DC reactor between terminals [+1, +2/B1]. Please remove the jumper before connecting the DC reactor.
- Models above 22kW don't have a built-in brake chopper. Please connect an external optional brake resistor.
- When not used, please leave the terminals [+2/B1, -] open.
- Short-circuiting [B2] or [-] to [+2/B1] can damage the AC motor drive.

2.3.2 Main Circuit Terminals

Frame C

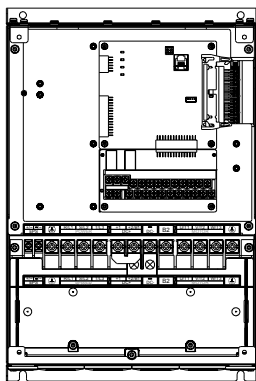

Main circuit terminals

R/L1, S/L2, T/L3, U/T1, V/T2, W/T3, , +1, +2/B1, -, B2

Models	Wire	Torque	Wire Type
VFD055VL23A	10-6 AWG. (5.3-13.3mm ²)	30kgf-cm (26in-lbf)	Stranded copper only, 75°C
VFD110VL43A			
VFD055VL43A	12-6 AWG. (3.3-13.3mm ²)		
VFD075VL43A			
VFD075VL23A	8-6 AWG. (8.4-13.3mm ²)		
VFD110VL23A	6 AWG. (13.3mm ²)		

Frame D

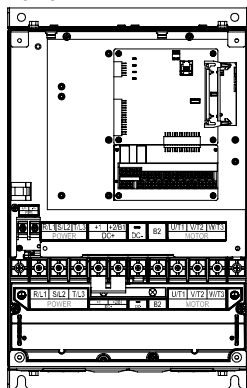

Main circuit terminals

R/L1, S/L2, T/L3, U/T1, V/T2, W/T3, , +1, +2, -

Models	Wire	Torque	Wire Type
VFD150VL43A	8-2 AWG. (8.4-33.6mm ²)	50Kgf-cm (43.4 lbf-in)	Stranded copper only, 75°C
VFD185VL43A			
VFD150VL23A	4-2 AWG. (21.1-33.6mm ²)		
VFD185VL23A	3-2 AWG. (26.7-33.6mm ²)		
VFD220VL43A	6-2 AWG (13.3-33.6mm ²)		
VFD220VL23A	3-2 AWG (26.7-33.6mm ²)		

Frame E

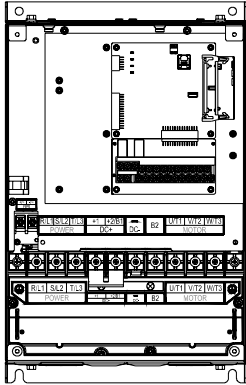

Main circuit terminals

R/L1, S/L2, T/L3, U/T1, V/T2, W/T3, ⊕, +1, +2, -

Models	Wire	Torque	Wire Type
VFD300VL43A	4-2 AWG. (21.2-33.6mm ²)	57kgf-cm (49in-lbf)	Stranded copper only, 75 °C
VFD370VL43A			
VFD450VL43A			
VFD300VL23A		200kgf-cm (173in-lbf)	
VFD370VL23A			
VFD550VL43A			
VFD750VL43A			

2.4 Control Terminals

① Sink /NPN Mode

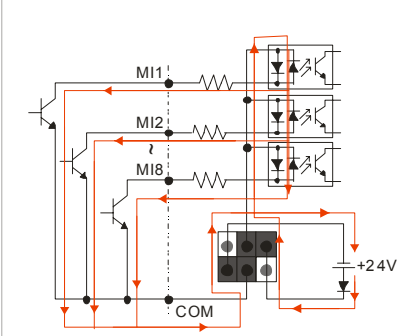

② Source Mode
used with internal power (+24Vdc)

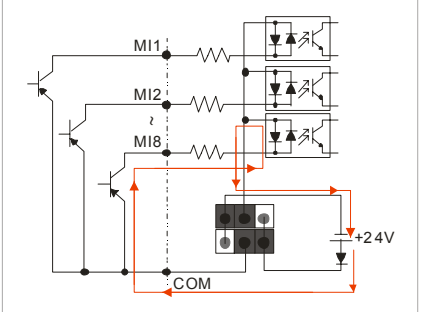

The Position of External Terminals

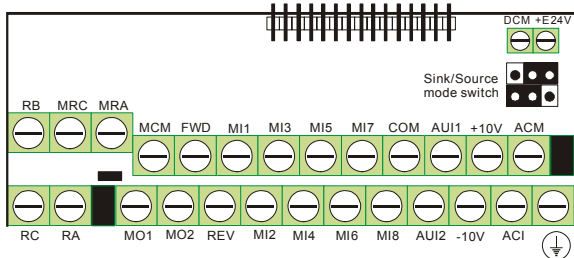

Terminal symbols and functions

Terminal Symbol	Terminal Function	Factory Settings (SINK) ON: Connect to DCM
FWD	Forward-Stop Command	ON: RUN in FWD direction OFF: Stop acc. to Stop Method
REV	Reverse-Stop Command	ON: RUN in REV direction OFF: Stop acc. to Stop Method
MI1	Multi-function Input 1	Refer to Pr.02-01 to Pr.02-08 for programming the Multi-function Inputs. ON: input voltage is 24Vdc (Max. 30Vdc), input impedance is 3.75kΩ OFF: leakage current tolerance is 10μA. MI8: when JP1 is inserted, this function is disabled.
MI2	Multi-function Input 2	
MI3	Multi-function Input 3	
MI4	Multi-function Input 4	
MI5	Multi-function Input 5	
MI6	Multi-function Input 6	
MI7	Multi-function Input 7	
MI8	Multi-function Input 8	
COM	Digital Signal Common	Common for digital inputs and used for SINK mode
+E24V	Digital Signal Common (Source)	+24V 80mA
DCM	Digital Signal Common (Sink)	Common for digital inputs and used for SINK mode
RA	Multi-function Relay Output 1 (N.O.) a	Resistive Load: 5A(N.O.)/3A(N.C.) 240VAC 5A(N.O.)/3A(N.C.) 24VDC Inductive Load: 1.5A(N.O.)/0.5A(N.C.) 240VAC 1.5A(N.O.)/0.5A(N.C.) 24VDC
RB	Multi-function Relay Output 1 (N.C.) b	
RC	Multi-function Relay Common	
MRA	Multi-function Relay Output 2 (N.O.) a	To output monitor signal, including in operation, frequency arrival, overload and etc.
MRC	Multi-function Relay Common	Refer to Pr.02-11~02-12 for programming
+10V -10V	Potentiometer Power Supply	-10~+10VDC 20mA (variable resistor 3-5kohm)
MCM	Multi-function Output Common (Photocoupler)	Max. 48VDC 50mA

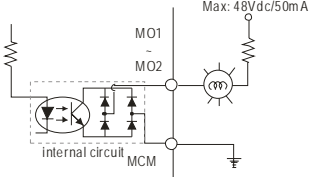
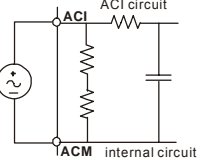
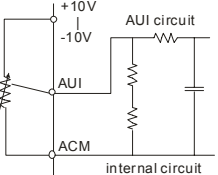
Terminal Symbol	Terminal Function	Factory Settings (SINK) ON: Connect to DCM
MO1	Multi-function Output 1 (Photocoupler)	<p>The AC motor drive output every monitor signal, such as operational, frequency attained, overload, etc. by open collector transistor. Refer to Pr.03.01 multi-function output terminals for details.</p> 
MO2	Multi-function Output 2 (Photocoupler)	
ACI	<p>Analog current Input</p> 	<p>Impedance: 250Ω</p> <p>Resolution: 12 bits</p> <p>Range: 4 ~ 20mA/0~10V = 0 ~ Max. Output Frequency (Pr.01-00)</p> <p>Set-up: Pr.03-00 ~ Pr.03-02</p>
AUI1/ AUI2	<p>Auxiliary analog voltage input</p> 	<p>Impedance: 2mΩ</p> <p>Resolution: 12 bits</p> <p>Range: -10 ~ +10VDC = 0 ~ Max. Output Frequency (Pr.01-00)</p> <p>Set-up: Pr.03-00 ~ Pr.03-02</p>
ACM	Analog control signal (common)	Common for ACI, AUI1, AUI2

*Control signal wiring size: 18 AWG (0.75 mm²) with shielded wire.

Analog input terminals (ACI, AUI1, AUI2, ACM)

- Analog input signals are easily affected by external noise. Use shielded wiring and keep it as short as possible (<20m) with proper grounding. If the noise is inductive, connecting the shield to terminal ACM can bring improvement.

- If the analog input signals are affected by noise from the AC motor drive, please connect a capacitor and ferrite core as indicated in the following diagrams:

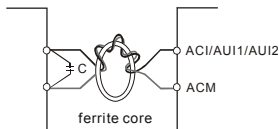

wind each wires 3 times or more around the core

Digital inputs (FWD, REV, MI1~MI8, COM)

- When using contacts or switches to control the digital inputs, please use high quality components to avoid contact bounce.

Digital outputs (MO1, MO2, MCM)

- Make sure to connect the digital outputs to the right polarity, see wiring diagrams.
- When connecting a relay to the digital outputs, connect a surge absorber or fly-back diode across the coil and check the polarity.

The specification for the control terminals

The Position of External Terminals

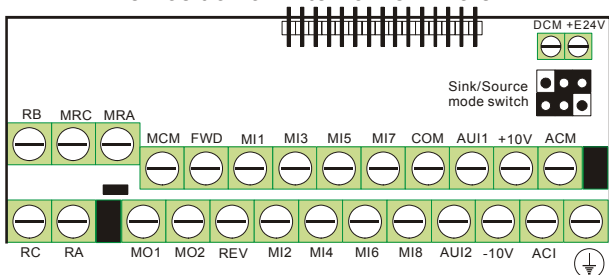

Frame	Torque	Wire
C, D, E	8 kgf-cm (6.9 in-lbf)	22-14 AWG (0.3-2.1mm ²)
	Terminal: 0V/24V 1.6 kgf-cm(1.4 in-lbf)	30-16 AWG (0.051-1.3mm ²)

NOTE

Frame C: VFD055VL23A/43A, VFD075VL23A/43A, VFD110VL23A/43A

Frame D: VFD150VL23A/43A, VFD185VL23A/43A, VFD220VL23A/43A

Frame E: VFD300VL23A/43A, VFD370VL23A/43A, VFD450VL43A, VFD550VL43A, VFD750VL43A

Chapter 3 Operation and Start Up





- Make sure that the wiring is correct. In particular, check that the output terminals U/T1, V/T2, W/T3 are NOT connected to power and that the drive is well grounded.
- Verify that no other equipment is connected to the AC motor
- Do NOT operate the AC motor drive with humid hands.
- Verify that there are no short-circuits between terminals and from terminals to ground or mains power.
- Check for loose terminals, connectors or screws.
- Make sure that the front cover is well installed before applying power.



- Please do NOT touch output terminals U, V, W when power is still applied to L1/R, L2/S, L3/T even when the AC motor drive has stopped. The DC-link capacitors may still be charged to hazardous voltage levels, even if the power has been turned off.

3.1 Operation Method

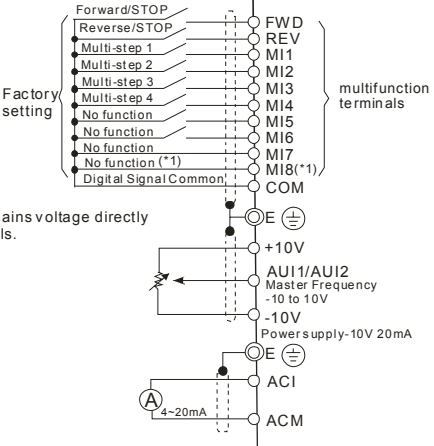
The factory setting for operation method is set to control terminal. But it is just one of the operation methods. The operation method can be via communication, control terminals settings or optional digital keypad KPVL-CC01. Please choose a suitable method depending on application and operation rule. The operation is usually used as shown in the following table.

Operation Method	Frequency Source	Operation Command Source		
Operate from communication	Please refer to the communication address 2000H and 2119H settings in the communication address definition.			
Control Terminals- Operate from external signal	<p>Factory setting: SINK Mode * </p>  <p>NOTE * Don't apply the mains voltage directly to above terminals.</p> <p>(**1) When JP1  on the control board is inserted, MI8 is disabled.</p>			
KPVL-CC01 keypad (Optional)	 <table border="1" data-bbox="263 1249 905 1332"> <tr> <td data-bbox="263 1249 739 1332">UP/DOWN key</td> <td data-bbox="739 1249 905 1332">RUN, STOP/RESET key</td> </tr> </table>		UP/DOWN key	RUN, STOP/RESET key
UP/DOWN key	RUN, STOP/RESET key			

3.2 Trial Run

The factory setting of operation source is from external terminals.

1. Please connect a switch for both external terminals FWD-COM and REV-COM. When Pr02-08=40 (default) enable the drive by activating MI8
2. Please connect a potentiometer among AUI1/AUI2, +10V, -10V and ACM or apply power -10~+10Vdc to AUI1/AUI2-ACM.
3. Setting the potentiometer or -10~+10Vdc power to less than 1V.
4. Make sure that all external terminal wirings are finished before applying power. After applying power, verify that LED "READY" is ON.
5. Setting FWD-COM=ON for forward running. And if you want to change to reverse running direction, you should set REV-COM=ON. And if you want to decelerate to stop, please set FWD/REV-COM=OFF.
6. Check following items:
 - Check if the motor direction of rotation is correct.
 - Check if the motor runs steadily without abnormal noise and vibration.
 - Check if acceleration and deceleration are smooth.

If the results of trial run are normal, please start the formal run.

3.3 Auto-tuning Operations

3.3.1 Flow Chart

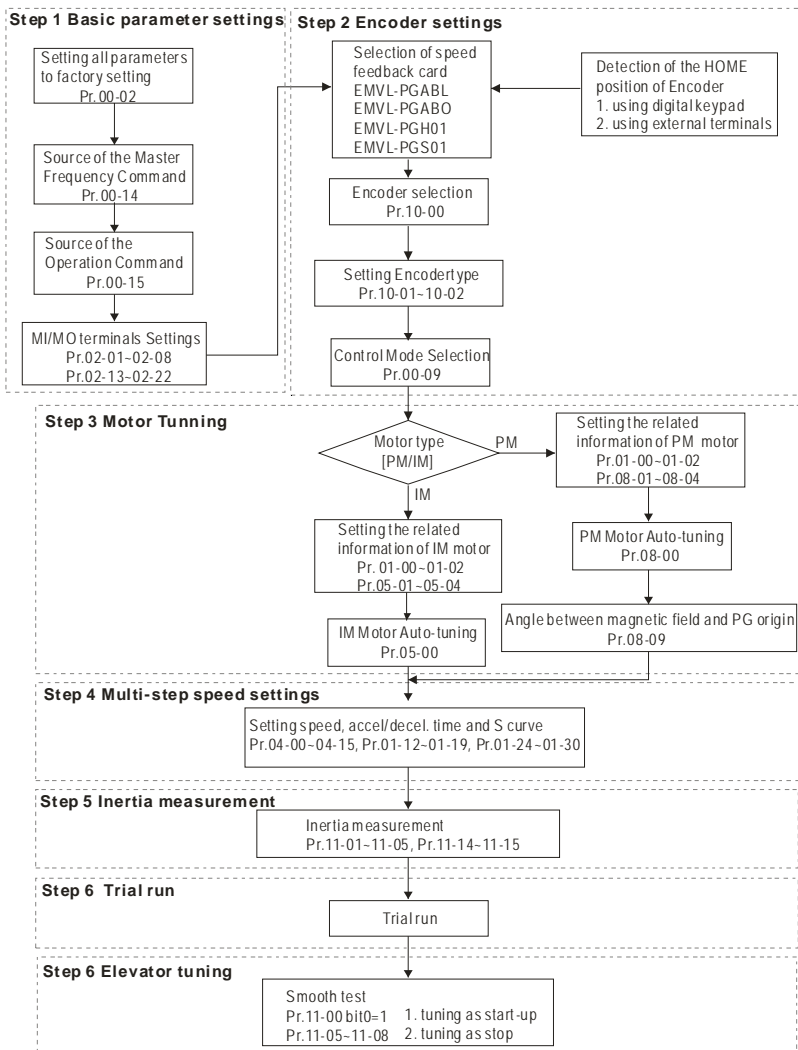

3.3.2 Explanations for the Auto-tuning Steps

3.3.2.1 Step 1

Basic parameters settings

- Make sure that Pr.00-00 (identity code of the AC motor drive) corresponds with the nameplate indicated on the AC motor drive.
- Make sure that all parameters are reset to factory setting (Pr.00-02 is set to 9 or 10).

Pr.00-02 Parameter Reset	0: No function 1: Read only 8: Keypad lock 9: All parameters are reset to factory settings (50Hz, 220V/380V) 10: All parameters are reset to factory settings (60Hz, 220V/440V)
-----------------------------	---

- Source of the Master Frequency Command: users can set by themselves (Pr.00-14)

Pr.00-14 Source of the Master Frequency Command	1: RS-485 serial communication or digital keypad (KPV-L-CC01) 2: External analog input (Pr. 03-00) 3: Digital terminals input
--	---

- Source of the Operation Command: users can set by themselves (Pr.00-15)

Pr.00-15 Source of the Operation Command	1: External terminals 2: RS-485 serial communication or digital keypad (KPV-L-CC01)
---	--

- MI/MO external terminals settings:

Refer to Pr.02-01~02-08 for setting the external input terminals MI1~MI8.

NOTE: The factory setting of Pr.02-08 is 40 (Enable drive function). Please disable this function if you don't need to use this function.

Settings of Pr.02-01~02-08	0: no function 1: multi-step speed command 1 2: multi-step speed command 2 3: multi-step speed command 3 4: multi-step speed command 4 5: Reset 6: JOG command 7: acceleration/deceleration speed inhibit 8: the 1st, 2nd acceleration/deceleration time selection 9: the 3rd, 4th acceleration/deceleration time selection 10: EF input (07-28) 11: Reserved 12: Stop output 13: Reserved
----------------------------	---

Settings of Pr.02-01~02-08	14: Reserved 15: operation speed command form AUI1 16: operation speed command form ACI 17: operation speed command form AUI2 18: Emergency Stop (07-28) 19-23: Reserved 24: FWD JOG command 25: REV JOG command 26: Reserved 27: ASR1/ASR2 selection 28: Emergency stop (EF1) (Motor coasts to stop) 29-30: Reserved 31: High torque bias (by Pr.07-21) 32: Middle torque bias (by Pr.07-22) 33: Low torque bias (by Pr.07-23) 34-37: Reserved 38: Disable write EEPROM function 39: Torque command direction 40: Enable drive function 41: Detection for magnetic contactor 42: Mechanical brake 43: EPS function
----------------------------	--

Refer to Pr.02-13~02-22 for setting external output terminals MO1~MO10.

Settings of Pr.02-13~02-22	0: No function 1: Operation indication 2: Operation speed attained 3: Desired frequency attained 1 (Pr.02-25) 4: Desired frequency attained 2 (Pr.02-27) 5: Zero speed (frequency command) 6: Zero speed with stop (frequency command) 7: Over torque (OT1) (Pr.06-05~06-07) 8: Over torque (OT2) (Pr.06-08~06-10) 9: Drive ready 10: User-defined Low-voltage Detection (LV) 11: Malfunction indication 12: Mechanical brake release (Pr.02-29, Pr.02-30) 13: Overheat (Pr.06-14) 14: Brake chopper signal 15: Motor-controlled magnetic contactor output 16: Slip error (oSL) 17: Malfunction indication 1
----------------------------	---

Settings of Pr.02-13~02-22	18: Reserved 19: Brake chopper output error 20: Warning output 21: Over voltage warning 22: Over-current stall prevention warning 23: Over-voltage stall prevention warning 24: Operation mode indication (Pr.00-15≠0) 25: Forward command 26: Reverse command 27: Output when current >= Pr.02-33 28: Output when current < Pr.02-33 29: Output when frequency >= Pr.02-34 30: Output when frequency < Pr.02-34 31-32: Reserved 33: Zero speed (actual output frequency) 34: Zero speed with Stop (actual output frequency) 35: Error output selection 1 (Pr.06-22) 36: Error output selection 2 (Pr.06-23) 37: Error output selection 3 (Pr.06-24) 38: Error output selection 4 (Pr.06-25) 39: Reserved 40: Speed attained (including zero speed) 41: Reserved
----------------------------	--

3.3.2.2 Step 2

Encoder settings

- Selection of speed feedback cards

Please refer to appendix B.8 for details. Delta provides 4 PG cards for user to select by their application, including EMVL-PGABL, EMVL-PGABO, EMVL-PGH01 and EMVL-PGS01.

Pr.10-00 PG signal type	0: No function 1: ABZ 2: ABZ+Hall 3: SIN/COS+Sinusoidal 4: SIN/COS+Endat 5: SIN/COS 6: SIN/COS + Hiperface
----------------------------	--

- Encoder settings: Pr.10-01~Pr.10-02

Detection for the magnetic pole position of motor

The detection method will be different by the setting of Pr.10-00 PG Signal Type.

The detection methods: (refer to Pr.10-00)

1. Setting 1 or 5: The AC motor drive will output short circuit to detect the position of the magnetic pole. At this moment, the motor will generate a little noise.
2. Setting 2: The AC motor drive will detect the position of the magnetic pole by the UVW signal of PG.
3. Setting 3: The AC motor drive will detect the position of the magnetic pole by the sine signal of PG.
4. Setting 4: The AC motor drive will detect the position of the magnetic pole by the communication signal of PG.

Reference table for tuning

Setting of PG signal type	PG signal type	Applicable PG card	Pr.08-00=1	Pr.08-00=3
10-00=1	A, B, Z	EMVL-PGABO/ABL	Motor will run	Motor will run
10-00=2	A, B, Z+U, V, W	EMVL-PGABL	Motor will run	Motor will run
10-00=3	SIN/COS+ Sinusoidal	EMVL-PGH01/02	Motor will run	Motor will run
10-00=4	SIN/COS+Endat	EMVL-PGS01	Motor will run	Motor won't run
10-00=5	SIN/COS	EMVL-PGH01/02	Motor will run	Motor will run
10-00=6	SIN/COS + Hiperface	EMVL-PGS01	Motor will run	Motor won't run

Pr.10-01 Encoder Pulse	1~25000
---------------------------	---------

Pr.10-02 Encoder Input Type Setting	0: Disable 1: Phase A leads in a forward run command and phase B leads in a reverse run command 2: Phase B leads in a forward run command and phase A leads in a reverse run command 3: Phase A is a pulse input and phase B is a direction input. (low input=reverse direction, high input=forward direction) 4: Phase A is a pulse input and phase B is a direction input. (low input=forward direction, high input=reverse direction) 5: Single-phase input
--	---

3.3.2.3 Step 3

Motor tuning

- Setting the parameters according to the motor type (PM or IM)
- Motor Auto-tuning: When the Source of the Operation Command is set to digital keypad (Pr.00-15=2, refer to step 1)
- Control method: Please set Pr.00-09 to 8.

Pr.00-09 Control Method	0: V/f Control 1: V/f Control + Encoder (VFPG) 2: Sensorless vector control (SVC) 3: FOC vector control + Encoder (FOCPG) 4: Torque control + Encoder (TQCPG) 8: FOC PM control (FOCPM)
----------------------------	--

- NOTE: Setting parameter by the motor type (PM or IM).
- Inputting the nameplate information on the motor into Pr.01-00~01-02

Pr.01-00 Maximum Output Frequency	10.00~120.00Hz
--------------------------------------	----------------

Pr.01-01 1st Output Frequency Setting 1 (base frequency/motor rated frequency)	0.00~120.00Hz
--	---------------

Pr.01-02 1st Output Voltage Setting 1 (base voltage/motor rated voltage)	230V: 0.1V~255.0V 460V: 0.1V~510.0V
--	--

IM

- Motor Auto-tuning: When the Source of the Operation Command is set to digital keypad (Pr.00-15=2, refer to step 1) and setting Pr.05-00=2

Pr.05-00 Motor Auto tuning	0: No function 1: Rolling test (Rs, Rr, Lm, Lx, no-load current) 2: Static Test
-------------------------------	---

NOTE 1: It doesn't need to release the brake in this auto tuning operation. Please make sure that the electromagnetic valve is ON when it is used between the AC motor drive and motor. When Pr.05-00 is set to 2, no-load current of motor must be entered into Pr.05-05. The warning message "Auto tuning" will be displayed on the digital keypad during tuning until it is finished. Then, the measure result will be saved into Pr.05-06~Pr.05-09.

NOTE 2: It needs to finish motor auto tuning before measuring the angle between magnetic pole and PG origin.

Pr.05-01 Full-load Current of Motor	(40~120%)*00-01 Amps
--	----------------------

Pr.05-02 Rated power of Motor	0.00~655.35kW
Pr.05-03 Rated speed of Motor (rpm)	0~65535
Pr.05-04 Number of Motor Poles	2~48

PM

- Motor Auto-tuning: When the Source of the Operation Command is set to digital keypad (Pr.00-15=2, refer to step 1) and setting Pr.08-00=2

Pr.08-00 Motor Auto tuning	<p>0: No function</p> <p>1: Only for the unloaded motor, auto measure the Angle between magnetic pole and PG origin (08-09)</p> <p>2: For PM parameters</p> <p>3: Auto measure the Angle between magnetic pole and PG origin (08-09)</p>
-------------------------------	--

NOTE 1: It doesn't need to release the brake in this auto tuning operation. Please make sure that the electromagnetic valve is ON when it is used between the AC motor drive and motor. The warning message "Auto tuning" will be displayed on the digital keypad during tuning until it is finished. Then, the measure result will be saved into Pr.08-05 and Pr.08-07. (Pr.08-05 is Rs of Motor and Pr.08-07 is Lq of Motor)

NOTE 2: It is recommended to set Pr.08-00 to 1 (unloaded motor) for the most accurate calculation. If it needs to execute this function with loaded motor, please balance the carriage before execution. When Pr.08-00=1, please note:

- When executing the function of auto measure the Angle between magnetic pole and PG origin, it is recommended to stop the carriage car at the middle level.
- Make sure that the electromagnetic valve and mechanical brake are OFF before executing this function.
- When Pr.08-00=1, please execute this function with unloaded motor to get the most accurate result. If it needs to execute this function with loaded motor, please balance the carriage before execution. Make sure the balance by releasing the brake manually before running. This balance will affect the accuracy and the accuracy will influence the power efficiency in driving the motor.

NOTE 3: If it doesn't allow balancing carriage in the measured environment, it can set Pr.08-00 to 3 for executing this function. It will have a difference of 15~30° by the different encoder type.

- When Pr.08-00 is set to 3, the driver will execute the function by the setting of Pr.10-00. The difference between Pr.08-00=3 and Pr.08-00=1 is it doesn't need to put the

balanced carriage when Pr.08-00=3. Besides, the operation status of the motor will be as shown in the above table (Pr.10-00=1, 2, 3 and 5, the motor will run. Pr.10-00=4 and 6, the motor won't run)

- When Pr.08-00=3, please make sure if the setting of Pr.10-02 is correct. The incorrect setting will result in the wrong position of the magnetic pole and make the wrong angle between magnetic pole and PG origin.

NOTE 4: The warning message "Auto tuning" will be displayed on the digital keypad during tuning until it is finished. Then, the measure result will be saved into Pr.08-09.

NOTE 5: If the warning message "Auto Tuning Err" displayed on the digital keypad during tuning due to abnormal drive or human factor, please check if the wiring is correct. When the warning message "PG Fbk Error" displayed on the digital keypad, please change the setting of Pr.10-02 (for example: if it was set to 1, please change it to 2). When the warning message "PG Fbk Loss" is displayed on the digital keypad, please check the feedback of Z-phase pulse.

Pr.08-01 Full-load Current of Motor	(40~120%)*00-01 Amps
Pr.08-02 Rated power of Motor	0.00~655.35 kW
Pr.08-03 Rated speed of Motor (rpm)	0~65535
Pr.08-04 Number of Motor Poles	2~96

- Measure the angle between magnetic pole and PG origin

It can execute "RUN" by keypad or digital terminals:

1. Using digital keypad: setting Pr.08-00 to 1 and press "RUN" to execute "auto measure the angle between magnetic pole and PG origin". Please note that if the electromagnetic valve and brake are not controlled by the AC motor drive, please release it by manual.
2. Using external terminals: setting Pr.00-14=3 (frequency source) and Pr.00-15=1 (operation source). Please use "inspection" function to execute "auto measure the angle between magnetic pole and PG origin".

For the IM, it doesn't need to detect the position of the magnetic pole, this function (auto measure the Angle between magnetic pole and PG origin) doesn't have to be executed.

Measure the angle between magnetic pole and PG origin: Pr.08-00=1 or 3

Pr.08-00 Motor Auto tuning	0: No function 1: Only for the unloaded motor, auto measure the Angle between magnetic pole and PG origin
-------------------------------	--

	(08-09) 2: For PM parameters 3: Auto measure the Angle between magnetic pole and PG origin (08-09)
--	--

NOTE: The function of "auto measure the angle between magnetic pole and Pg origin" only can be enabled after finishing motor auto-tuning.

3.3.2.4 Step 4

Multi-step speed settings

- Please confirm the total speed steps (high speed, middle speed, low speed, creep, inspection and level auto-learning)
- Please make sure that the setting of step speeds and the action of the corresponding terminals of multi-function input commands are correct.
- Setting multi-step speeds in Pr.04-00 to Pr.04-15

Settings of Pr.04-00 to Pr.04-15	Zero Step Speed Frequency	0.00~400.00Hz
	1st Step Speed Frequency	0.00~400.00Hz
	2nd Step Speed Frequency	0.00~400.00Hz
	3rd Step Speed Frequency	0.00~400.00Hz
	4th Step Speed Frequency	0.00~400.00Hz
	5th Step Speed Frequency	0.00~400.00Hz
	6th Step Speed Frequency	0.00~400.00Hz
	7th Step Speed Frequency	0.00~400.00Hz
	8th Step Speed Frequency	0.00~400.00Hz
	9th Step Speed Frequency	0.00~400.00Hz
	10th Step Speed Frequency	0.00~400.00Hz
	11th Step Speed Frequency	0.00~400.00Hz
	12th Step Speed Frequency	0.00~400.00Hz
	13th Step Speed Frequency	0.00~400.00Hz
	14th Step Speed Frequency	0.00~400.00Hz
15th Step Speed Frequency	0.00~400.00Hz	

NOTE: It is recommended to set the max. operating frequency to the half of max. operating frequency before confirming the setting of each step speed and the action of the corresponding terminals of multi-function input commands.

- Setting the acceleration/deceleration with Pr.01-23 and the setting 08 (the 1st, 2nd acceleration/deceleration time selection) and 09 (the 3rd, 4th acceleration/deceleration time selection) of multi-function input command Pr.02-01~02-08.
- Settings of acceleration/deceleration time: Pr.01-12~Pr.01-19

Settings of Pr.01-12 to Pr.01-19	Accel Time 1	0.00~600.00 sec
	Decel Time 1	0.00~600.00 sec
	Accel Time 2	0.00~600.00 sec
	Decel Time 2	0.00~600.00 sec
	Accel Time 3	0.00~600.00 sec
	Decel Time 3	0.00~600.00 sec
	Accel Time 4	0.00~600.00 sec
	Decel Time 4	0.00~600.00 sec

NOTE: it is recommended to set the Pr.01-31 (deceleration time) to the small value in the trial run and execute smooth test after all the actions are correct.

- Settings of S curve: Pr.01-24~Pr.01-30

Settings of Pr.01-24 to Pr.01-30	S-curve for Acceleration Departure Time S1	0.00~25.00 sec
	S-curve for Acceleration Arrival Time S2	0.00~25.00 sec
	S-curve for Deceleration Departure Time S3	0.00~25.00 sec
	S-curve for Deceleration Arrival Time S4	0.00~25.00 sec
	Mode Selection when Frequency < Fmin	0: Output waiting 1: Zero-speed operation 2: Fmin (4th output frequency setting)
	Switch Frequency for S3/S4 Changes to S5	0.00~400.00Hz
	S-curve for Deceleration Arrival Time S5	0.00~25.00 sec

NOTE: it is recommended to set the S curve time to 0 in trial run and execute smooth test after all the actions are correct.

3.3.2.5 Step 5

Inertia

Elevator speed

Pr.11-01 Elevator Speed	0.10~4.00 m/s
Pr.11-02 Sheave Diameter	100~2000 mm
Pr.11-03 Mechanical Gear Ratio	1~100
Pr.11-04 Suspension Ratio	0: 1:1 1: 2:1
Pr.11-05 Inertial Ratio	1~300%
Pr.11-14 Motor Current at Accel.	50~200%
Pr.11-15 Elevator Acceleration	0.20~2.00m/s ²

3.3.2.6 Step 6

Trial run

This step is used to trial run after finishing the settings of Step 1 to Step 5 to check if it runs normally after executing the inspection with the loaded motor. At the same time, please also check if the operations of multi-function output terminals is normal, such as the action of the brake release and electromagnetic valve correspond to the host controller.

It needs to check the switch between each step speed, current value, the noise in the carriage and noise source during operation.

3.3.2.7 Step 7

Elevator tuning

1. Setting Pr. 11-00 to bit 0=1

Pr.11-00 System control	Bit 0=0: disable Bit 0=1: ASR Auto tuning, PDFF enable Bit 7=1: When position control is enabled, it doesn't need to set Pr.07-02 (DC Brake Current Level) Bit 15=0: when power is applied, it will detect the position of magnetic pole again Bit 15=1: when power is applied, it will start from the magnetic pole position of previous power failure
----------------------------	---

NOTE: bit 15=0, it will detect the position of magnetic pole when the power is applied. (it will detect every time when the power is applied.)

Bit 15=1: when power is applied, it will start from the magnetic pole position of previous power failure. Please make sure that the motor is not manually rotated during power off. If the motor has been rotated during power off, please set Pr.08-10=1 for magnetic pole re-orientation.

2. Smooth test for general operation

- Adjust the setting of Pr.11-05

Pr.11-05 Inertial Ratio	1~300%
----------------------------	--------

- Adjust the settings of Pr.11-06 to Pr.11-08

Settings of Pr.11-06 to Pr.11-08	Zero-speed Bandwidth	0~40Hz
	Low-speed Bandwidth	0~40Hz
	High-speed Bandwidth	0~40Hz

3. Start-up adjustment (only for PM)

- Control by the zero-speed position

Setting Pr.11-00, 10-19, 10-22, 10-23, 02-29 and 10-24

Pr.11-00 System control	Bit 0=0: disable Bit 0=1: ASR Auto tuning, PDFF enable Bit 7=1: When position control is enabled, it doesn't need to set Pr.07-02 (DC Brake Current Level) Bit 15=0: when power is applied, it will detect the position of magnetic pole again Bit 15=1: when power is applied, it will start from the magnetic pole position of previous power failure
Pr.10-19 Zero Speed Gain (P)	0~655.00%

NOTE: refer to the explanations in Pr.02-32

Pr.10-22 Operation Time of Zero Speed	0.000~65.535sec
Pr.10-23 Filter Time of Zero Speed	0.000~65.535sec
Pr.10-24 Time for Zero Speed Execution	0: after the brake release set in Pr.02-29 1: after the brake signal input (Pr.02-01~02-08 is set to 42)
Pr.02-29 Brake Release Delay Time when Elevator Starts	0.000~65.000 Sec

NOTE: When Pr.10-24=0, the zero speed control needs to be used with Pr.02-29. (refer to the explanations in Pr.02-32)

■ Function of the preload input

Please connect the signal of the preload signal to the external terminal of the AC motor drive (AUI1) and setting Pr.03-00=11, 07-19=1, 03-03, 03-06 and 03-09.

Pr.03-00 Analog Input 1 (AUI1)	0: No function 1: Frequency command (torque limit under TQR control mode) 2: Torque command (torque limit under speed mode) 3: Torque compensation command 4-5: Reserved 6: P.T.C. thermistor input value 7: Positive torque limit 8: Negative torque limit 9: Regenerative torque limit 10: Positive/negative torque limit
Pr.07-19 Source of Torque Offset	0: Disable 1: Analog input (Pr.03-00) 2: Torque offset setting (Pr.07-20) 3: Control by external terminal (by Pr.07-21 to Pr.07-23)

Pr.03-03 Analog Input Bias 1 (AU1)	-100.0~100.0%
--	---------------

Pr.03-06 Positive/negative Bias Mode (AU1)	0: Zero bias 1: Lower than bias=bias 2: Greater than bias=bias 3: The absolute value of the bias voltage while serving as the center 4: Serve bias as the center
--	--

Pr.03-09 Analog Input Gain 1 (AU1)	-500.0~500.0%
--	---------------

NOTE: Pr.03-03, 03-06 and 03-09 are used to adjust the analog input signal.

07-19: Source of torque offset

03-00~02: Analog input selections (AU1/AC1/AU2)

03-03~05: Analog input bias (AU1/AC1/AU2)

03-06~08: AU1/AC1/AU2 bias mode

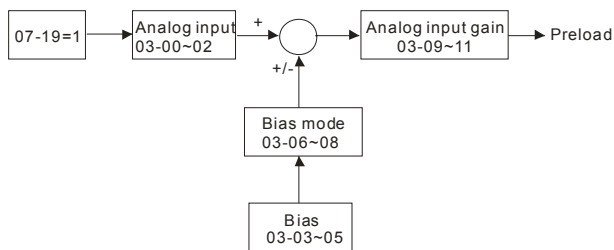

4. Setting of drive stop

Adjusting Pr.01-29, Pr.01-30, Pr.01-31 and Pr.11-06

Pr.01-29 Switch Frequency for S3/S4 Changes to S5	0.00~400.00Hz
---	---------------

Pr.01-30 S-curve for Deceleration Arrival Time S5	0.00~25.00 sec
--	----------------

Pr.11-06 Zero-speed Bandwidth	0~40Hz
----------------------------------	--------

Pr.01-31 Deceleration Time	0.00~600.00 sec
-------------------------------	-----------------

Chapter 4 Parameters

The VFD-VL parameters are divided into 14 groups by property for easy setting. In most applications, the user can finish all parameter settings before start-up without the need for re-adjustment during operation.

The 14 groups are as follows:

Group 0: System Parameters

Group 1: Basic Parameters

Group 2: Digital Input/Output Parameters

Group 3: Analog Input/Output Parameters

Group 4: Multi-Step Speed Parameters

Group 5: IM Parameters

Group 6: Protection Parameters

Group 7: Special Parameters

Group 8: PM Parameters

Group 9: Communication Parameters

Group 10: Speed Feedback Control Parameters

Group 11: Advanced Parameters

Group 12: User-defined Parameters

Group 13: View User-defined Parameters

4.1 Summary of Parameter Settings

ℵ: The parameter can be set during operation.

4.1.1 Group 0 System Parameters

Pr.	Explanation	Settings	Factory Setting	VF	VFPG	SVC	FOCPG	TOCPG	FOCPM
00-00	Identity Code of the AC motor drive	Read-only	#	○	○	○	○	○	○
00-01	Rated Current Display of the AC motor drive	Read-only	#	○	○	○	○	○	○
00-02	Parameter Reset	0: No function 1: Read only 8: Keypad lock 9: All parameters are reset to factory settings (50Hz, 220V/380V) 10: All parameters are reset to factory settings (60Hz, 220V/440V)	0	○	○	○	○	○	○
ℵ00-03	Start-up Display Selection	0: Display the frequency command value (LED F) 1: Display the actual output frequency (LED H) 2: DC BUS voltage 3: Display the output current (A) 4: Output voltage 5: Multifunction display, see Pr.00-04	0	○	○	○	○	○	○
ℵ00-04	Content of Multi Function Display	0: Display output current (A) 1: Reserved 2: Display output frequency (H) 3: Display DC-BUS voltage (U) 4: Display output voltage (E) 5: Output power factor angle (n) 6: Display output power kW(P) 7: Display actual motor speed in rpm(r) 8: Display estimate output torque % 9: Display PG position (G) 10: Display the electrical angle of drive output 11: Display AU1 % (1.) 12: Display AC1 % (2.) 13: Display AU2 % (3.) 14: Display the temperature of heat sink (°C) 15: Display the temperature of IGBT °C (T.) 16: The status of digital input ON/OFF (i) 17: The status of digital output ON/OFF (o) 18: Multi-step speed (S) 19: The corresponding CPU pin status of digital input (i.) 20: The corresponding CPU pin status of digital output (o.) 21-23: Reserved 24: Output AC voltage when malfunction (8) 25: Output DC voltage when malfunction (8.) 26: Motor frequency when malfunction (h) 27: Output current when malfunction (4) 28: Output frequency when malfunction (h.) 29: Frequency command when malfunction 30: Output power when malfunction 31: Output torque when malfunction 32: Input terminal status when malfunction 33: Output terminal status when malfunction 34: Drive status when malfunction	0	○	○	○	○	○	○
ℵ00-05	User-Defined Coefficient K	Digit 4: decimal point number (0 to 3) Digit 0-3: 40 to 9999	0	○	○	○	○	○	○
00-06	Software Version	Read-only	##	○	○	○	○	○	○
ℵ00-07	Password Input	1 to 9998 and 10000 to 65535 0 to 2: times of wrong password	0	○	○	○	○	○	○
ℵ00-08	Password Set	1 to 9998 and 10000 to 65535 0: No password set or successful input in Pr.00-07 1: Password has been set	0	○	○	○	○	○	○
00-09	Control Method	0: V/f Control 1: V/f Control + Encoder (VFPG) 2: Sensorless vector control (SVC) 3: FOC vector control + Encoder (FOCPG)	0	○	○	○	○	○	○

Pr.	Explanation	Settings	Factory Setting	VF	VFG	SVC	FOCPG	TOCPG	FOCPM
		4: Torque control + Encoder (TQCPG) 8: FOC PM control (FOCPM)							
↗00-10	Speed Unit	0: Hz 1: m/s 2: ft/s	0	<input type="radio"/>	<input type="radio"/>	<input type="radio"/>	<input type="radio"/>	<input type="radio"/>	<input type="radio"/>
00-11	Output Direction Selection	0: FWD: counterclockwise, REV: clockwise 1: FWD: clockwise, REV: counterclockwise	0	<input type="radio"/>	<input type="radio"/>	<input type="radio"/>	<input type="radio"/>	<input type="radio"/>	<input type="radio"/>
↗00-12	Carrier Frequency	2~15KHz	12	<input type="radio"/>	<input type="radio"/>	<input type="radio"/>	<input type="radio"/>	<input type="radio"/>	<input type="radio"/>
↗00-13	Auto Voltage Regulation (AVR) Function	0: Enable AVR 1: Disable AVR 2: Disable AVR when deceleration stop	0	<input type="radio"/>	<input type="radio"/>	<input type="radio"/>	<input type="radio"/>	<input type="radio"/>	<input type="radio"/>
↗00-14	Source of the Master Frequency Command	1: RS-485 serial communication or digital keypad (KPV-L-CC01) 2: External analog input (Pr. 03-00) 3: Digital terminals input (Pr. 04-00~04-15)	1	<input type="radio"/>	<input type="radio"/>	<input type="radio"/>	<input type="radio"/>	<input type="radio"/>	<input type="radio"/>
↗00-15	Source of the Operation Command	1: External terminals 2: RS-485 serial communication or digital keypad (KPV-L-CC01)	1	<input type="radio"/>	<input type="radio"/>	<input type="radio"/>	<input type="radio"/>	<input type="radio"/>	<input type="radio"/>

4.1.2 Group 1 Basic Parameters

Pr.	Explanation	Settings	Factory Setting	VF	VFG	SVC	FOCPG	TOCPG	FOCPM
01-00	Maximum Output Frequency	10.00~400.00Hz	60.00/ 50.00	<input type="checkbox"/>	<input type="checkbox"/>	<input type="checkbox"/>	<input type="checkbox"/>	<input type="checkbox"/>	<input type="checkbox"/>
01-01	1st Output Frequency Setting 1	0.00~400.00Hz	60.00/ 50.00	<input type="checkbox"/>	<input type="checkbox"/>	<input type="checkbox"/>	<input type="checkbox"/>	<input type="checkbox"/>	<input type="checkbox"/>
01-02	1st Output Voltage Setting 1	230V: 0.1V~255.0V 460V: 0.1V~510.0V	220.0 440.0	<input type="checkbox"/>	<input type="checkbox"/>	<input type="checkbox"/>	<input type="checkbox"/>	<input type="checkbox"/>	<input type="checkbox"/>
01-03	2nd Output Frequency Setting 1	0.00~400.00Hz	0.50	<input type="checkbox"/>	<input type="checkbox"/>				
↯01-04	2nd Output Voltage Setting 1	230V: 0.1V~255.0V 460V: 0.1V~510.0V	5.0 10.0	<input type="checkbox"/>	<input type="checkbox"/>				
01-05	3rd Output Frequency Setting 1	0.00~400.00Hz	0.50	<input type="checkbox"/>	<input type="checkbox"/>				
↯01-06	3rd Output Voltage Setting 1	230V: 0.1V~255.0V 460V: 0.1V~510.0V	5.0 10.0	<input type="checkbox"/>	<input type="checkbox"/>				
01-07	4th Output Frequency Setting 1	0.00~400.00Hz	0.00	<input type="checkbox"/>	<input type="checkbox"/>	<input type="checkbox"/>	<input type="checkbox"/>	<input type="checkbox"/>	
↯01-08	4th Output Voltage Setting 1	230V: 0.1V~255.0V 460V: 0.1V~510.0V	0.0 0.0	<input type="checkbox"/>	<input type="checkbox"/>				
01-09	Start Frequency	0.00~400.00Hz	0.50	<input type="checkbox"/>	<input type="checkbox"/>	<input type="checkbox"/>	<input type="checkbox"/>		
↯01-10	Output Frequency Upper Limit	0.00~400.00Hz	120.00	<input type="checkbox"/>	<input type="checkbox"/>	<input type="checkbox"/>	<input type="checkbox"/>		<input type="checkbox"/>
↯01-11	Output Frequency Lower Limit	0.00~400.00Hz	0.00	<input type="checkbox"/>	<input type="checkbox"/>	<input type="checkbox"/>	<input type="checkbox"/>		<input type="checkbox"/>
↯01-12	Accel Time 1	0.00~600.00 sec	3.00	<input type="checkbox"/>	<input type="checkbox"/>	<input type="checkbox"/>	<input type="checkbox"/>		<input type="checkbox"/>
↯01-13	Decel Time 1	0.00~600.00 sec	2.00	<input type="checkbox"/>	<input type="checkbox"/>	<input type="checkbox"/>	<input type="checkbox"/>		<input type="checkbox"/>
↯01-14	Accel Time 2	0.00~600.00 sec	3.00	<input type="checkbox"/>	<input type="checkbox"/>	<input type="checkbox"/>	<input type="checkbox"/>		<input type="checkbox"/>
↯01-15	Decel Time 2	0.00~600.00 sec	2.00	<input type="checkbox"/>	<input type="checkbox"/>	<input type="checkbox"/>	<input type="checkbox"/>		<input type="checkbox"/>
↯01-16	Accel Time 3	0.00~600.00 sec	3.00	<input type="checkbox"/>	<input type="checkbox"/>	<input type="checkbox"/>	<input type="checkbox"/>		<input type="checkbox"/>
↯01-17	Decel Time 3	0.00~600.00 sec	2.00	<input type="checkbox"/>	<input type="checkbox"/>	<input type="checkbox"/>	<input type="checkbox"/>		<input type="checkbox"/>
↯01-18	Accel Time 4	0.00~600.00 sec	3.00	<input type="checkbox"/>	<input type="checkbox"/>	<input type="checkbox"/>	<input type="checkbox"/>		<input type="checkbox"/>
↯01-19	Decel Time 4	0.00~600.00 sec	2.00	<input type="checkbox"/>	<input type="checkbox"/>	<input type="checkbox"/>	<input type="checkbox"/>		<input type="checkbox"/>
↯01-20	JOG Acceleration Time	0.00~600.00 sec	1.00	<input type="checkbox"/>	<input type="checkbox"/>	<input type="checkbox"/>	<input type="checkbox"/>		<input type="checkbox"/>
↯01-21	JOG Deceleration Time	0.00~600.00 sec	1.00	<input type="checkbox"/>	<input type="checkbox"/>	<input type="checkbox"/>	<input type="checkbox"/>		<input type="checkbox"/>
↯01-22	JOG Frequency	0.00~400.00Hz	6.00	<input type="checkbox"/>	<input type="checkbox"/>	<input type="checkbox"/>	<input type="checkbox"/>	<input type="checkbox"/>	<input type="checkbox"/>
↯01-23	Switch Frequency between 1st/4th Accel/decel	0.00~400.00Hz	0.00	<input type="checkbox"/>	<input type="checkbox"/>	<input type="checkbox"/>	<input type="checkbox"/>		<input type="checkbox"/>
↯01-24	S-curve for Acceleration Departure Time S1	0.00~25.00 sec	1.00	<input type="checkbox"/>	<input type="checkbox"/>	<input type="checkbox"/>	<input type="checkbox"/>		<input type="checkbox"/>
↯01-25	S-curve for Acceleration Arrival Time S2	0.00~25.00 sec	1.00	<input type="checkbox"/>	<input type="checkbox"/>	<input type="checkbox"/>	<input type="checkbox"/>		<input type="checkbox"/>
↯01-26	S-curve for Deceleration Departure Time S3	0.00~25.00 sec	1.00	<input type="checkbox"/>	<input type="checkbox"/>	<input type="checkbox"/>	<input type="checkbox"/>		<input type="checkbox"/>
↯01-27	S-curve for Deceleration Arrival Time S4	0.00~25.00 sec	1.00	<input type="checkbox"/>	<input type="checkbox"/>	<input type="checkbox"/>	<input type="checkbox"/>		<input type="checkbox"/>
01-28	Mode Selection when Frequency < Fmin	0: Output waiting 1: Zero-speed operation 2: Fmin (4th output frequency setting)	0	<input type="checkbox"/>	<input type="checkbox"/>	<input type="checkbox"/>			
↯01-29	Switch Frequency for S3/S4 Changes to S5	0.00~400.00Hz	0.00	<input type="checkbox"/>	<input type="checkbox"/>	<input type="checkbox"/>	<input type="checkbox"/>		<input type="checkbox"/>
↯01-30	S-curve for Deceleration Arrival Time S5	0.00~25.00 sec	1.00	<input type="checkbox"/>	<input type="checkbox"/>	<input type="checkbox"/>	<input type="checkbox"/>		<input type="checkbox"/>
↯01-31	Deceleration Time when Operating without RUN Command	0.00~60.00 sec	2.00	<input type="checkbox"/>	<input type="checkbox"/>	<input type="checkbox"/>	<input type="checkbox"/>		<input type="checkbox"/>

4.1.3 Group 2 Digital Input/Output Parameters

Pr.	Explanation	Settings	Factory Setting	VF	VFP	SVC	F0CPG	T0CPG	F0CPM
02-00	2-wire/3-wire Operation Control	0: FWD/STOP, REV/STOP 1: FWD/STOP, REV/STOP (Line Start Lockout) 2: RUN/STOP, REV/FWD 3: RUN/STOP, REV/FWD (Line Start Lockout) 4: 3-wire 5: 3-wire (Line Start Lockout)	0	<input type="checkbox"/>	<input type="checkbox"/>	<input type="checkbox"/>	<input type="checkbox"/>	<input type="checkbox"/>	<input type="checkbox"/>
02-01	Multi-Function Input Command 1 (MI1) (it is Stop terminal for 3-wire operation)	0: no function 1: multi-step speed command 1 2: multi-step speed command 2	1	<input type="checkbox"/>	<input type="checkbox"/>	<input type="checkbox"/>	<input type="checkbox"/>	<input type="checkbox"/>	<input type="checkbox"/>
02-02	Multi-Function Input Command 2 (MI2)	3: multi-step speed command 3 4: multi-step speed command 4	2	<input type="checkbox"/>	<input type="checkbox"/>	<input type="checkbox"/>	<input type="checkbox"/>	<input type="checkbox"/>	<input type="checkbox"/>
02-03	Multi-Function Input Command 3 (MI3)	5: Reset 6: JOG command	3	<input type="checkbox"/>	<input type="checkbox"/>	<input type="checkbox"/>	<input type="checkbox"/>	<input type="checkbox"/>	<input type="checkbox"/>
02-04	Multi-Function Input Command 4 (MI4)	7: acceleration/deceleration speed inhibit 8: the 1st, 2nd acceleration/deceleration time selection	4	<input type="checkbox"/>	<input type="checkbox"/>	<input type="checkbox"/>	<input type="checkbox"/>	<input type="checkbox"/>	<input type="checkbox"/>
02-05	Multi-Function Input Command 5 (MI5)	9: the 3rd, 4th acceleration/deceleration time selection 10: EF input (07-28) 11: Reserved	0	<input type="checkbox"/>	<input type="checkbox"/>	<input type="checkbox"/>	<input type="checkbox"/>	<input type="checkbox"/>	<input type="checkbox"/>
02-06	Multi-Function Input Command 6 (MI6)	12: Stop output 13: Reserved 14: Reserved 15: operation speed command form AUI1 16: operation speed command form ACI	0	<input type="checkbox"/>	<input type="checkbox"/>	<input type="checkbox"/>	<input type="checkbox"/>	<input type="checkbox"/>	<input type="checkbox"/>
02-07	Multi-Function Input Command 7 (MI7)	17: operation speed command form AUI2	0	<input type="checkbox"/>	<input type="checkbox"/>	<input type="checkbox"/>	<input type="checkbox"/>	<input type="checkbox"/>	<input type="checkbox"/>
02-08	Multi-Function Input Command 8 (MI8) (When JP1 on the control board is inserted, MI8 functions acc. to Pr02-08.) (When JP1 on the control board is removed, MI8 is always "enable" independent of Pr02-08.)	18: Emergency Stop (07-28) 19-23: Reserved 24: FWD JOG command 25: REV JOG command 26: Reserved 27: ASR1/ASR2 selection 28: Emergency stop (EF1) (Motor coasts to stop) 29-30: Reserved 31: High torque bias (by Pr.07-21) 32: Middle torque bias (by Pr.07-22) 33: Low torque bias (by Pr.07-23) 34-37: Reserved 38: Disable write EEPROM function 39: Torque command direction 40: Enable drive function 41: Detection of magnetic contactor 42: Mechanical brake 43: EPS function	40	<input type="checkbox"/>	<input type="checkbox"/>	<input type="checkbox"/>	<input type="checkbox"/>	<input type="checkbox"/>	<input type="checkbox"/>
↗02-09	Digital Input Response Time	0.001~ 30.000 sec	0.005	<input type="checkbox"/>	<input type="checkbox"/>	<input type="checkbox"/>	<input type="checkbox"/>	<input type="checkbox"/>	<input type="checkbox"/>
↗02-10	Digital Input Operation Direction	0 ~ 65535	0	<input type="checkbox"/>	<input type="checkbox"/>	<input type="checkbox"/>	<input type="checkbox"/>	<input type="checkbox"/>	<input type="checkbox"/>
↗02-11	Multi-function Output 1 RA, RB, RC(Relay1)	0: No function 1: Operation indication	11	<input type="checkbox"/>	<input type="checkbox"/>	<input type="checkbox"/>	<input type="checkbox"/>	<input type="checkbox"/>	<input type="checkbox"/>
↗02-12	Multi-function Output 2 MRA, MRC (Relay2)	2: Operation speed attained 3: Desired frequency attained 1 (Pr.02-25)	1	<input type="checkbox"/>	<input type="checkbox"/>	<input type="checkbox"/>	<input type="checkbox"/>	<input type="checkbox"/>	<input type="checkbox"/>
↗02-13	Multi-function Output 3 (MO1)	4: Desired frequency attained 2 (Pr.02-27) 5: Zero speed (frequency command) 6: Zero speed with stop (frequency command) 7: Over torque (OT1) (Pr.06-05~06-07) 8: Over torque (OT2) (Pr.06-08~06-10)	0	<input type="checkbox"/>	<input type="checkbox"/>	<input type="checkbox"/>	<input type="checkbox"/>	<input type="checkbox"/>	<input type="checkbox"/>
↗02-14	Multi-function Output 4 (MO2)	9: Drive ready 10: User-defined Low-voltage Detection (LV) 11: Malfunction indication	0	<input type="checkbox"/>	<input type="checkbox"/>	<input type="checkbox"/>	<input type="checkbox"/>	<input type="checkbox"/>	<input type="checkbox"/>
↗02-15	Multi-function Output 5	12: Mechanical brake release (Pr.02-29, Pr.02-30)	0	<input type="checkbox"/>	<input type="checkbox"/>	<input type="checkbox"/>	<input type="checkbox"/>	<input type="checkbox"/>	<input type="checkbox"/>

Chapter 4 Parameters | VFD-VL

Pr.	Explanation	Settings	Factory Setting	VF	VFG	SVC	FOPG	TOCPG	FOPM
	(MO3)	13: Overheat (Pr.06-14)		○	○	○	○	○	○
↗02-16	Multi-function Output 6 (MO4)	14: Brake chopper signal	0	○	○	○	○	○	○
		15: Motor-controlled magnetic contactor output	0	○	○	○	○	○	○
		16: Slip error (oS _L)		○	○	○	○	○	○
↗02-17	Multi-function Output 7 (MO5)	17: Malfunction indication 1		○	○	○	○	○	○
		18: Reserved		○	○	○	○	○	○
		19: Brake chopper output error		○	○	○	○	○	○
		20: Warning output	0	○	○	○	○	○	○
↗02-18	Multi-function Output 8 (MO6)	21: Over voltage warning		○	○	○	○	○	○
		22: Over-current stall prevention warning	0	○	○	○	○	○	○
↗02-19	Multi-function Output 9 (MO7)	23: Over-voltage stall prevention warning		○	○	○	○	○	○
		24: Operation mode indication (Pr.00-15#0 and PU LED on KPVL-CC01 is off)	0	○	○	○	○	○	○
↗02-20	Multi-function Output 10 (MO8)	25: Forward command		○	○	○	○	○	○
		26: Reverse command	0	○	○	○	○	○	○
↗02-21	Multi-function Output 11 (MO9)	27: Output when current ≥ Pr.02-33		○	○	○	○	○	○
		28: Output when current < Pr.02-33	0	○	○	○	○	○	○
↗02-22	Multi-function Output 12 (MO10)	29: Output when frequency ≥ Pr.02-34		○	○	○	○	○	○
		30: Output when frequency < Pr.02-34	0	○	○	○	○	○	○
		31: Power generation direction and status verify		○	○	○	○	○	○
		32: Power generation direction		○	○	○	○	○	○
		33: Zero speed (actual output frequency)		○	○	○	○	○	○
		34: Zero speed with Stop (actual output frequency)		○	○	○	○	○	○
		35: Fault output option 1 (Pr.06-22)		○	○	○	○	○	○
		36: Fault output option 2 (Pr.06-23)		○	○	○	○	○	○
		37: Fault output option 3 (Pr.06-24)		○	○	○	○	○	○
		38: Fault output option 4 (Pr.06-25)		○	○	○	○	○	○
↗02-23	Multi-output Direction	39: Reserved		○	○	○	○	○	○
		40: Speed attained (including zero speed)	0	○	○	○	○	○	○
02-24	Serial Start Signal Selection	41: Reserved		○	○	○	○	○	○
		0 ~ 65535	0	○	○	○	○	○	○
↗02-25	Desired Frequency Attained 1	0: by FWD/REV 1: by Enable	0	○	○	○	○	○	
↗02-26	The Width of the Desired Frequency Attained 1	0.00 ~ 400.00Hz	60.00/ 50.00	○	○	○	○	○	
↗02-27	Desired Frequency Attained 2	0.00 ~ 400.00Hz	2.00	○	○	○	○	○	
↗02-28	The Width of the Desired Frequency Attained 2	0.00 ~ 400.00Hz	60.00/ 50.00	○	○	○	○	○	
↗02-29	Brake Release Delay Time when Elevator Starts	0.00~65.000 Sec	2.00	○	○	○	○	○	
↗02-30	Brake Engage Delay Time when Elevator Stops	0.00~65.000 Sec	0.250	○	○	○	○	○	
↗02-31	Turn On Delay of Magnetic Contactor between Drive and Motor	0.000~65.000 Sec	0.250	○	○	○	○	○	
↗02-32	Turn Off Delay of Magnetic Contactor between Drive and Motor	0.000~65.000 Sec	0.200	○	○	○	○	○	
↗02-33	Output Current Level Setting for External Terminals	0~100%	0.200	○	○	○	○	○	
↗02-34	Output Boundary for External Terminals	0.00~+400.00Hz (it is motor speed when using with PG)	0	○	○	○	○	○	
↗02-35	Detection Time of Mechanical Brake	0.00~10.00 Sec	0.00	○	○	○	○	○	
↗02-36	Detection Time of Contactor	0.00~10.00 Sec	0.00	○	○	○	○	○	
02-37	Check Torque Output Function	0: Enable 1: Disable	0.00	○	○	○	○	○	

4.1.4 Group 3 Analog Input/Output Parameters

Pr.	Explanation	Settings	Factory Setting	VF	VFC	SVC	FOCPG	TOCPG	FOCPM
↗03-00	Analog Input 1 (AUI1)	0: No function	1	<input type="radio"/>	<input type="radio"/>	<input type="radio"/>	<input type="radio"/>	<input type="radio"/>	<input type="radio"/>
↗03-01	Analog Input 2 (ACI)	1: Frequency command (torque limit under TQR control mode)	0	<input type="radio"/>	<input type="radio"/>	<input type="radio"/>	<input type="radio"/>	<input type="radio"/>	<input type="radio"/>
↗03-02	Analog Input 3 (AUI2)	2: Torque command (torque limit under speed mode)	0	<input type="radio"/>	<input type="radio"/>	<input type="radio"/>	<input type="radio"/>	<input type="radio"/>	<input type="radio"/>
		3: Preload Input		<input type="radio"/>	<input type="radio"/>	<input type="radio"/>	<input type="radio"/>	<input type="radio"/>	
		4-5: Reserved		<input type="radio"/>	<input type="radio"/>	<input type="radio"/>	<input type="radio"/>	<input type="radio"/>	
		6: P.T.C. thermistor input value		<input type="radio"/>	<input type="radio"/>	<input type="radio"/>	<input type="radio"/>	<input type="radio"/>	
		7: Positive torque limit		<input type="radio"/>	<input type="radio"/>	<input type="radio"/>	<input type="radio"/>	<input type="radio"/>	
		8: Negative torque limit		<input type="radio"/>	<input type="radio"/>	<input type="radio"/>	<input type="radio"/>	<input type="radio"/>	
		9: Regenerative torque limit		<input type="radio"/>	<input type="radio"/>	<input type="radio"/>	<input type="radio"/>	<input type="radio"/>	
	10: Positive/negative torque limit	<input type="radio"/>	<input type="radio"/>	<input type="radio"/>	<input type="radio"/>	<input type="radio"/>	<input type="radio"/>	<input type="radio"/>	
↗03-03	Analog Input Bias 1 (AUI1)	-100.0~100.0%	0.0	<input type="radio"/>	<input type="radio"/>	<input type="radio"/>	<input type="radio"/>	<input type="radio"/>	<input type="radio"/>
↗03-04	Analog Input Bias 2 (ACI)	-100.0~100.0%	0.0	<input type="radio"/>	<input type="radio"/>	<input type="radio"/>	<input type="radio"/>	<input type="radio"/>	<input type="radio"/>
↗03-05	Analog Input Bias 3 (AUI2)	-100.0~100.0%	0.0	<input type="radio"/>	<input type="radio"/>	<input type="radio"/>	<input type="radio"/>	<input type="radio"/>	<input type="radio"/>
↗03-06	Positive/negative Bias Mode (AUI1)	0: Zero bias	0	<input type="radio"/>	<input type="radio"/>	<input type="radio"/>	<input type="radio"/>	<input type="radio"/>	<input type="radio"/>
↗03-07	Positive/negative Bias Mode (ACI) (can be set to 0 or 1 only)	1: Serve bias as the center, lower than bias=bias 2: Serve bias as the center, greater than bias=bias 3: The absolute value of the bias voltage while serving as the center (single polar)		<input type="radio"/>	<input type="radio"/>	<input type="radio"/>	<input type="radio"/>	<input type="radio"/>	<input type="radio"/>
↗03-08	Positive/negative Bias Mode (AUI2)	4: Serve bias as the center (single polar)		<input type="radio"/>	<input type="radio"/>	<input type="radio"/>	<input type="radio"/>	<input type="radio"/>	<input type="radio"/>
↗03-09	Analog Input Gain 1 (AUI1)	-500.0~500.0%	100.0	<input type="radio"/>	<input type="radio"/>	<input type="radio"/>	<input type="radio"/>	<input type="radio"/>	<input type="radio"/>
↗03-10	Analog Input Gain 2 (ACI)	-500.0~500.0%	100.0	<input type="radio"/>	<input type="radio"/>	<input type="radio"/>	<input type="radio"/>	<input type="radio"/>	<input type="radio"/>
↗03-11	Analog Input Gain 3 (AUI2)	-500.0~500.0%	100.0	<input type="radio"/>	<input type="radio"/>	<input type="radio"/>	<input type="radio"/>	<input type="radio"/>	<input type="radio"/>
↗03-12	Analog Input Delay Time (AUI1)	0.00~2.00 sec	0.01	<input type="radio"/>	<input type="radio"/>	<input type="radio"/>	<input type="radio"/>	<input type="radio"/>	<input type="radio"/>
↗03-13	Analog Input Delay Time (ACI)	0.00~2.00 sec	0.01	<input type="radio"/>	<input type="radio"/>	<input type="radio"/>	<input type="radio"/>	<input type="radio"/>	<input type="radio"/>
↗03-14	Analog Input Delay Time (AUI2)	0.00~2.00 sec	0.01	<input type="radio"/>	<input type="radio"/>	<input type="radio"/>	<input type="radio"/>	<input type="radio"/>	<input type="radio"/>
↗03-15	Loss of the ACI Signal	0: Disable	0	<input type="radio"/>	<input type="radio"/>	<input type="radio"/>	<input type="radio"/>	<input type="radio"/>	<input type="radio"/>
		1: Continue operation at the last frequency		<input type="radio"/>	<input type="radio"/>	<input type="radio"/>	<input type="radio"/>	<input type="radio"/>	
		2: Decelerate to 0Hz		<input type="radio"/>	<input type="radio"/>	<input type="radio"/>	<input type="radio"/>	<input type="radio"/>	
		3: Stop immediately and display E.F.		<input type="radio"/>	<input type="radio"/>	<input type="radio"/>	<input type="radio"/>	<input type="radio"/>	
03-16	Reserved								
↗03-17	Analog Output Selection 1	0: Output frequency (Hz)	0	<input type="radio"/>	<input type="radio"/>	<input type="radio"/>	<input type="radio"/>	<input type="radio"/>	<input type="radio"/>
		1: Frequency command (Hz)		<input type="radio"/>	<input type="radio"/>	<input type="radio"/>	<input type="radio"/>	<input type="radio"/>	
		2: Motor speed (RPM)		<input type="radio"/>	<input type="radio"/>	<input type="radio"/>	<input type="radio"/>	<input type="radio"/>	
		3: Output current (rms)		<input type="radio"/>	<input type="radio"/>	<input type="radio"/>	<input type="radio"/>	<input type="radio"/>	
		4: Output voltage		<input type="radio"/>	<input type="radio"/>	<input type="radio"/>	<input type="radio"/>	<input type="radio"/>	
		5: DC Bus Voltage		<input type="radio"/>	<input type="radio"/>	<input type="radio"/>	<input type="radio"/>	<input type="radio"/>	
		6: Power factor		<input type="radio"/>	<input type="radio"/>	<input type="radio"/>	<input type="radio"/>	<input type="radio"/>	
		7: Power		<input type="radio"/>	<input type="radio"/>	<input type="radio"/>	<input type="radio"/>	<input type="radio"/>	
		8: Output torque		<input type="radio"/>	<input type="radio"/>	<input type="radio"/>	<input type="radio"/>	<input type="radio"/>	
		9: AUI1		<input type="radio"/>	<input type="radio"/>	<input type="radio"/>	<input type="radio"/>	<input type="radio"/>	
		10: ACI		<input type="radio"/>	<input type="radio"/>	<input type="radio"/>	<input type="radio"/>	<input type="radio"/>	
		11: AUI2		<input type="radio"/>	<input type="radio"/>	<input type="radio"/>	<input type="radio"/>	<input type="radio"/>	
		12: q-axis current		<input type="radio"/>	<input type="radio"/>	<input type="radio"/>	<input type="radio"/>	<input type="radio"/>	
		13: q-axis feedback value		<input type="radio"/>	<input type="radio"/>	<input type="radio"/>	<input type="radio"/>	<input type="radio"/>	
		14: d-axis current		<input type="radio"/>	<input type="radio"/>	<input type="radio"/>	<input type="radio"/>	<input type="radio"/>	
		15: d-axis feedback value		<input type="radio"/>	<input type="radio"/>	<input type="radio"/>	<input type="radio"/>	<input type="radio"/>	
		16: q-axis voltage		<input type="radio"/>	<input type="radio"/>	<input type="radio"/>	<input type="radio"/>	<input type="radio"/>	
		17: d-axis voltage		<input type="radio"/>	<input type="radio"/>	<input type="radio"/>	<input type="radio"/>	<input type="radio"/>	
		18: Torque command		<input type="radio"/>	<input type="radio"/>	<input type="radio"/>	<input type="radio"/>	<input type="radio"/>	
		19-20: Reserved		<input type="radio"/>	<input type="radio"/>	<input type="radio"/>	<input type="radio"/>	<input type="radio"/>	
↗03-18	Analog Output Gain 1	0~200.0%	100.0	<input type="radio"/>	<input type="radio"/>	<input type="radio"/>	<input type="radio"/>	<input type="radio"/>	<input type="radio"/>

Pr.	Explanation	Settings	Factory Setting	VF	VFPG	SVC	FOCPG	TOCPG	FOCPM
↗03-19	Analog Output Value in REV Direction 1	0: Absolute value in REV direction 1: Output 0V in REV direction 2: Enable output voltage in REV direction	0	<input type="checkbox"/>	<input type="checkbox"/>	<input type="checkbox"/>	<input type="checkbox"/>	<input type="checkbox"/>	<input type="checkbox"/>
↗03-20	Analog Output Selection 2	0: Output frequency (Hz) 1: Frequency command (Hz) 2: Motor speed (RPM) 3: Output current (rms) 4: Output voltage 5: DC Bus Voltage 6: Power factor 7: Power 8: Output torque 9: AVI 10: ACI 11: AUI 12: q-axis current 13: q-axis feedback value 14: d-axis current 15: d-axis feedback value 16: q-axis voltage 17: d-axis voltage 18: Torque command 19-20: Reserved	0	<input type="checkbox"/>	<input type="checkbox"/>	<input type="checkbox"/>	<input type="checkbox"/>	<input type="checkbox"/>	<input type="checkbox"/>
↗03-21	Analog Output Gain 2	0~200.0%	100.0	<input type="checkbox"/>	<input type="checkbox"/>	<input type="checkbox"/>	<input type="checkbox"/>	<input type="checkbox"/>	<input type="checkbox"/>
↗03-22	Analog Output Value in REV Direction 2	0: Absolute value in REV direction 1: Output 0V in REV direction 2: Enable output voltage in REV direction	0	<input type="checkbox"/>	<input type="checkbox"/>	<input type="checkbox"/>	<input type="checkbox"/>	<input type="checkbox"/>	<input type="checkbox"/>
03-23	Analog Input Type (AUI1)	0: Bipolar (±10V) 1: Unipolar (0-10V)	0	<input type="checkbox"/>	<input type="checkbox"/>	<input type="checkbox"/>	<input type="checkbox"/>	<input type="checkbox"/>	<input type="checkbox"/>
03-24	Analog Input Type (AUI2)	0: Bipolar (±10V) 1: Unipolar (0-10V)	0	<input type="checkbox"/>	<input type="checkbox"/>	<input type="checkbox"/>	<input type="checkbox"/>	<input type="checkbox"/>	<input type="checkbox"/>

4.1.5 Group 4 Multi-Step Speed Parameters

Pr.	Explanation	Settings	Factory Setting	VF	VFPG	SVC	FOCPG	TOCPG	FOCPM
↙04-00	Zero Step Speed Frequency	0.00~400.00Hz	0.00	<input type="radio"/>	<input type="radio"/>	<input type="radio"/>	<input type="radio"/>	<input type="radio"/>	<input type="radio"/>
↙04-01	1st Step Speed Frequency	0.00~400.00Hz	0.00	<input type="radio"/>	<input type="radio"/>	<input type="radio"/>	<input type="radio"/>	<input type="radio"/>	<input type="radio"/>
↙04-02	2nd Step Speed Frequency	0.00~400.00Hz	0.00	<input type="radio"/>	<input type="radio"/>	<input type="radio"/>	<input type="radio"/>	<input type="radio"/>	<input type="radio"/>
↙04-03	3rd Step Speed Frequency	0.00~400.00Hz	0.00	<input type="radio"/>	<input type="radio"/>	<input type="radio"/>	<input type="radio"/>	<input type="radio"/>	<input type="radio"/>
↙04-04	4th Step Speed Frequency	0.00~400.00Hz	0.00	<input type="radio"/>	<input type="radio"/>	<input type="radio"/>	<input type="radio"/>	<input type="radio"/>	<input type="radio"/>
↙04-05	5th Step Speed Frequency	0.00~400.00Hz	0.00	<input type="radio"/>	<input type="radio"/>	<input type="radio"/>	<input type="radio"/>	<input type="radio"/>	<input type="radio"/>
↙04-06	6th Step Speed Frequency	0.00~400.00Hz	0.00	<input type="radio"/>	<input type="radio"/>	<input type="radio"/>	<input type="radio"/>	<input type="radio"/>	<input type="radio"/>
↙04-07	7th Step Speed Frequency	0.00~400.00Hz	0.00	<input type="radio"/>	<input type="radio"/>	<input type="radio"/>	<input type="radio"/>	<input type="radio"/>	<input type="radio"/>
↙04-08	8th Step Speed Frequency	0.00~400.00Hz	0.00	<input type="radio"/>	<input type="radio"/>	<input type="radio"/>	<input type="radio"/>	<input type="radio"/>	<input type="radio"/>
↙04-09	9th Step Speed Frequency	0.00~400.00Hz	0.00	<input type="radio"/>	<input type="radio"/>	<input type="radio"/>	<input type="radio"/>	<input type="radio"/>	<input type="radio"/>
↙04-10	10th Step Speed Frequency	0.00~400.00Hz	0.00	<input type="radio"/>	<input type="radio"/>	<input type="radio"/>	<input type="radio"/>	<input type="radio"/>	<input type="radio"/>
↙04-11	11th Step Speed Frequency	0.00~400.00Hz	0.00	<input type="radio"/>	<input type="radio"/>	<input type="radio"/>	<input type="radio"/>	<input type="radio"/>	<input type="radio"/>
↙04-12	12th Step Speed Frequency	0.00~400.00Hz	0.00	<input type="radio"/>	<input type="radio"/>	<input type="radio"/>	<input type="radio"/>	<input type="radio"/>	<input type="radio"/>
↙04-13	13th Step Speed Frequency	0.00~400.00Hz	0.00	<input type="radio"/>	<input type="radio"/>	<input type="radio"/>	<input type="radio"/>	<input type="radio"/>	<input type="radio"/>
↙04-14	14th Step Speed Frequency	0.00~400.00Hz	0.00	<input type="radio"/>	<input type="radio"/>	<input type="radio"/>	<input type="radio"/>	<input type="radio"/>	<input type="radio"/>
↙04-15	15th Step Speed Frequency	0.00~400.00Hz	0.00	<input type="radio"/>	<input type="radio"/>	<input type="radio"/>	<input type="radio"/>	<input type="radio"/>	<input type="radio"/>

4.1.6 Group 5 IM Parameters

Pr.	Explanation	Settings	Factory Setting	VF	VVFC	SVC	FOCPG	TOCPG	FOCPM
05-00	Motor Auto Tuning	0: No function 1: Rolling test (Rs, Rr, Lm, Lx, no-load current) 2: Static test	0	<input type="radio"/>					
05-01	Full-load Current of Motor	(40-120%)* Pr.00-01 Amps	###	<input type="checkbox"/>	<input type="checkbox"/>	<input type="checkbox"/>	<input type="checkbox"/>	<input type="checkbox"/>	<input type="checkbox"/>
05-02	Rated power of Motor	0.00~655.35kW	###	<input type="checkbox"/>	<input type="checkbox"/>	<input type="checkbox"/>	<input type="checkbox"/>	<input type="checkbox"/>	<input type="checkbox"/>
05-03	Rated speed of Motor (rpm)	0~65535	1710	<input type="checkbox"/>	<input type="checkbox"/>	<input type="checkbox"/>	<input type="checkbox"/>	<input type="checkbox"/>	<input type="checkbox"/>
05-04	Number of Motor Poles	2~48	4	<input type="checkbox"/>	<input type="checkbox"/>	<input type="checkbox"/>	<input type="checkbox"/>	<input type="checkbox"/>	<input type="checkbox"/>
05-05	No-load Current of Motor	0-100%	###	<input type="checkbox"/>	<input type="checkbox"/>	<input type="checkbox"/>	<input type="checkbox"/>	<input type="checkbox"/>	<input type="checkbox"/>
05-06	Rs of Motor	0.000~65.535Ω	0.000	<input type="checkbox"/>	<input type="checkbox"/>	<input type="checkbox"/>	<input type="checkbox"/>	<input type="checkbox"/>	<input type="checkbox"/>
05-07	Rr of Motor	0.000~65.535Ω	0.000	<input type="checkbox"/>	<input type="checkbox"/>	<input type="checkbox"/>	<input type="checkbox"/>	<input type="checkbox"/>	<input type="checkbox"/>
05-08	Lm of Motor	0.0~6553.5mH	0.0	<input type="checkbox"/>	<input type="checkbox"/>	<input type="checkbox"/>	<input type="checkbox"/>	<input type="checkbox"/>	<input type="checkbox"/>
05-09	Lx of Motor	0.0~6553.5mH	0.0	<input type="checkbox"/>	<input type="checkbox"/>	<input type="checkbox"/>	<input type="checkbox"/>	<input type="checkbox"/>	<input type="checkbox"/>
↗05-10	Torque Compensation Time Constant	0.001~10.000sec	0.020	<input type="checkbox"/>	<input type="checkbox"/>	<input type="checkbox"/>	<input type="checkbox"/>	<input type="checkbox"/>	<input type="checkbox"/>
↗05-11	Slip Compensation Time Constant	0.001~10.000sec	0.100	<input type="checkbox"/>	<input type="checkbox"/>	<input type="checkbox"/>	<input type="checkbox"/>	<input type="checkbox"/>	<input type="checkbox"/>
↗05-12	Torque Compensation Gain	0~10	0	<input type="checkbox"/>	<input type="checkbox"/>	<input type="checkbox"/>	<input type="checkbox"/>	<input type="checkbox"/>	<input type="checkbox"/>
↗05-13	Slip Compensation Gain	0.00~10.00	0.00	<input type="checkbox"/>	<input type="checkbox"/>	<input type="checkbox"/>	<input type="checkbox"/>	<input type="checkbox"/>	<input type="checkbox"/>
↗05-14	Slip Deviation Level	0~1000% (0: disable)	0	<input type="checkbox"/>	<input type="checkbox"/>	<input type="checkbox"/>	<input type="checkbox"/>	<input type="checkbox"/>	<input type="checkbox"/>
↗05-15	Detection Time of Slip Deviation	0.0~10.0 sec	1.0	<input type="checkbox"/>	<input type="checkbox"/>	<input type="checkbox"/>	<input type="checkbox"/>	<input type="checkbox"/>	<input type="checkbox"/>
↗05-16	Over Slip Treatment	0: Warn and keep operation 1: Warn and ramp to stop 2: Warn and coast to stop	0	<input type="checkbox"/>	<input type="checkbox"/>	<input type="checkbox"/>	<input type="checkbox"/>	<input type="checkbox"/>	<input type="checkbox"/>
↗05-17	Hunting Gain	0~10000 (0: disable)	2000	<input type="checkbox"/>	<input type="checkbox"/>	<input type="checkbox"/>	<input type="checkbox"/>	<input type="checkbox"/>	<input type="checkbox"/>
05-18	Accumulative Motor Operation Time (Min.)	00~1439	00	<input type="checkbox"/>	<input type="checkbox"/>	<input type="checkbox"/>	<input type="checkbox"/>	<input type="checkbox"/>	<input type="checkbox"/>
05-19	Accumulative Motor Operation Time (day)	00~65535	00	<input type="checkbox"/>	<input type="checkbox"/>	<input type="checkbox"/>	<input type="checkbox"/>	<input type="checkbox"/>	<input type="checkbox"/>
↗05-20	Core Loss Compensation	0~250%	10	<input type="checkbox"/>	<input type="checkbox"/>	<input type="checkbox"/>	<input type="checkbox"/>	<input type="checkbox"/>	<input type="checkbox"/>
05-21	Accumulative Drive Power-on Time (Min.)	00~1439	00	<input type="checkbox"/>	<input type="checkbox"/>	<input type="checkbox"/>	<input type="checkbox"/>	<input type="checkbox"/>	<input type="checkbox"/>
05-22	Accumulative Drive Power-on Time (day)	00~65535	00	<input type="checkbox"/>	<input type="checkbox"/>	<input type="checkbox"/>	<input type="checkbox"/>	<input type="checkbox"/>	<input type="checkbox"/>

4.1.7 Group 6 Protection Parameters

Pr.	Explanation	Settings	Factory Setting	VF	VFCG	SVC	FOCPG	TCOPG	FOCPM
↗06-00	Low Voltage Level	160.0~220.0Vdc	180.0	<input type="checkbox"/>	<input type="checkbox"/>	<input type="checkbox"/>	<input type="checkbox"/>	<input type="checkbox"/>	<input type="checkbox"/>
		320.0~440.0Vdc	360.0	<input type="checkbox"/>	<input type="checkbox"/>	<input type="checkbox"/>	<input type="checkbox"/>	<input type="checkbox"/>	<input type="checkbox"/>
↗06-01	Phase-loss Protection	0: Warn and keep operation 1: Warn and ramp to stop 2: Warn and coast to stop	2	<input type="checkbox"/>	<input type="checkbox"/>	<input type="checkbox"/>	<input type="checkbox"/>	<input type="checkbox"/>	<input type="checkbox"/>
↗06-02	Over-current Stall Prevention during Acceleration	00: disable 00~250%	00	<input type="checkbox"/>	<input type="checkbox"/>	<input type="checkbox"/>			
↗06-03	Over-current Stall Prevention during Operation	00: disable 00~250%	00	<input type="checkbox"/>	<input type="checkbox"/>	<input type="checkbox"/>			
↗06-04	Accel./Decel. Time Selection of Stall Prevention at constant speed	0: by current accel/decel time 1: by the 1st accel/decel time 2: by the 2nd accel/decel time 3: by the 3rd accel/decel time 4: by the 4th accel/decel time 5: by auto accel/decel time	0	<input type="checkbox"/>	<input type="checkbox"/>	<input type="checkbox"/>			
↗06-05	Over-torque Detection Selection (OT1)	0: disable 1: over-torque detection during constant speed operation, continue to operate after detection 2: over-torque detection during constant speed operation, stop operation after detection 3: over-torque detection during operation, continue to operate after detection 4: over-torque detection during operation, stop operation after detection	0	<input type="checkbox"/>	<input type="checkbox"/>	<input type="checkbox"/>	<input type="checkbox"/>	<input type="checkbox"/>	<input type="checkbox"/>
↗06-06	Over-torque Detection Level (OT1)	10~250%	150	<input type="checkbox"/>	<input type="checkbox"/>	<input type="checkbox"/>	<input type="checkbox"/>	<input type="checkbox"/>	<input type="checkbox"/>
↗06-07	Over-torque Detection Time (OT1)	0.0~60.0 sec	0.1	<input type="checkbox"/>	<input type="checkbox"/>	<input type="checkbox"/>	<input type="checkbox"/>	<input type="checkbox"/>	<input type="checkbox"/>
↗06-08	Over-torque Detection Selection (OT2)	0: disable 1: over-torque detection during constant speed operation, continue to operate after detection 2: over-torque detection during constant speed operation, stop operation after detection 3: over-torque detection during operation, continue to operate after detection 4: over-torque detection during operation, stop operation after detection	0	<input type="checkbox"/>	<input type="checkbox"/>	<input type="checkbox"/>	<input type="checkbox"/>	<input type="checkbox"/>	<input type="checkbox"/>
↗06-09	Over-torque Detection Level (OT2)	10~250%	150	<input type="checkbox"/>	<input type="checkbox"/>	<input type="checkbox"/>	<input type="checkbox"/>	<input type="checkbox"/>	<input type="checkbox"/>
↗06-10	Over-torque Detection Time (OT2)	0.0~60.0 sec	0.1	<input type="checkbox"/>	<input type="checkbox"/>	<input type="checkbox"/>	<input type="checkbox"/>	<input type="checkbox"/>	<input type="checkbox"/>
↗06-11	Current Limit	0~250%	200				<input type="checkbox"/>	<input type="checkbox"/>	<input type="checkbox"/>
06-12	Electronic Thermal Relay Selection	0: Inverter motor 1: Standard motor 2: Disable	2	<input type="checkbox"/>	<input type="checkbox"/>	<input type="checkbox"/>	<input type="checkbox"/>	<input type="checkbox"/>	<input type="checkbox"/>
↗06-13	Electronic Thermal Characteristic	30.0~600.0 sec	60.0	<input type="checkbox"/>	<input type="checkbox"/>	<input type="checkbox"/>	<input type="checkbox"/>	<input type="checkbox"/>	<input type="checkbox"/>
↗06-14	Heat Sink Over-heat (OH) Warning	0.0~110.0°C	85.0	<input type="checkbox"/>	<input type="checkbox"/>	<input type="checkbox"/>	<input type="checkbox"/>	<input type="checkbox"/>	<input type="checkbox"/>
↗06-15	Stall Prevention Limit Level	0~100% (refer to Pr.06-02, Pr.06-03)	50	<input type="checkbox"/>	<input type="checkbox"/>	<input type="checkbox"/>			
06-16	Present Fault Record	0: No fault	0	<input type="checkbox"/>	<input type="checkbox"/>	<input type="checkbox"/>	<input type="checkbox"/>	<input type="checkbox"/>	<input type="checkbox"/>
06-17	Second Most Recent Fault Record	1: Over-current during acceleration (ocA)	0	<input type="checkbox"/>	<input type="checkbox"/>	<input type="checkbox"/>	<input type="checkbox"/>	<input type="checkbox"/>	<input type="checkbox"/>
		2: Over-current during deceleration (ocd)		<input type="checkbox"/>	<input type="checkbox"/>	<input type="checkbox"/>	<input type="checkbox"/>	<input type="checkbox"/>	<input type="checkbox"/>
06-18	Third Most Recent Fault Record	3: Over-current during constant speed (ocn)	0	<input type="checkbox"/>	<input type="checkbox"/>	<input type="checkbox"/>	<input type="checkbox"/>	<input type="checkbox"/>	<input type="checkbox"/>
		4: Ground fault (GFF)		<input type="checkbox"/>	<input type="checkbox"/>	<input type="checkbox"/>	<input type="checkbox"/>	<input type="checkbox"/>	<input type="checkbox"/>
06-19	Fourth Most Recent Fault Record	5: IGBT short-circuit (occ)	0	<input type="checkbox"/>	<input type="checkbox"/>	<input type="checkbox"/>	<input type="checkbox"/>	<input type="checkbox"/>	<input type="checkbox"/>
		6: Over-current at stop (ocS)		<input type="checkbox"/>	<input type="checkbox"/>	<input type="checkbox"/>	<input type="checkbox"/>	<input type="checkbox"/>	<input type="checkbox"/>
06-20	Fifth Most Recent Fault Record	7: Over-voltage during acceleration (ovA)	0	<input type="checkbox"/>	<input type="checkbox"/>	<input type="checkbox"/>	<input type="checkbox"/>	<input type="checkbox"/>	<input type="checkbox"/>
		8: Over-voltage during deceleration (ovd)		<input type="checkbox"/>	<input type="checkbox"/>	<input type="checkbox"/>	<input type="checkbox"/>	<input type="checkbox"/>	<input type="checkbox"/>
06-21	Sixth Most Recent Fault Record	9: Over-voltage during constant speed (ovn)	0	<input type="checkbox"/>	<input type="checkbox"/>	<input type="checkbox"/>	<input type="checkbox"/>	<input type="checkbox"/>	<input type="checkbox"/>
		10: Over-voltage at stop (ovS)		<input type="checkbox"/>	<input type="checkbox"/>	<input type="checkbox"/>	<input type="checkbox"/>	<input type="checkbox"/>	<input type="checkbox"/>

Pr.	Explanation	Settings	Factory Setting	VF	VFP	SVC	FOP	TOCP	FOCP
		11: Low-voltage during acceleration (LvA) 12: Low-voltage during deceleration (Lvd) 13: Low-voltage during constant speed (Lvn) 14: Low-voltage at stop (LvS) 15: Phase loss (PHL) 16: IGBT heat sink over-heat (oH1) 17: Heat sink over-heat (oH2)(for 40HP above) 18: TH1 open loop error (tH1o) 19: TH2 open loop error (tH2o) 20: Fan error signal output 21: over-load (oL) (150% 1Min) 22: Motor over-load (EoL1) 23: Reserved 24: Motor PTC overheat (oH3) 25: Reserved 26: over-torque 1 (ot1) 27: over-torque 1 (ot2) 28: Reserved 29: Reserved 30: Memory write-in error (cF1) 31: Memory read-out error (cF2) 32: Isum current detection error (cd0) 33: U-phase current detection error (cd1) 34: V-phase current detection error (cd2) 35: W-phase current detection error (cd3) 36: Clamp current detection error (Hd0) 37: Over-current detection error (Hd1) 38: Over-voltage detection error (Hd2) 39: Ground current detection error (Hd3) 40: Auto tuning error (AuE) 41: PID feedback loss (AFE) 42: PG feedback error (PGF1) 43: PG feedback loss (PGF2) 44: PG feedback stall (PGF3) 45: PG slip error (PGF4) 46: PG ref input error (PGr1) 47: PG ref loss (PGr2) 48: Analog current input error (ACE) 49: External fault input (EF) 50: Emergency stop (EF1) 51: Reserved 52: Password error (PcodE) 53: Reserved 54: Communication error (cE1) 55: Communication error (cE2) 56: Communication error (cE3) 57: Communication error (cE4) 58: Communication Time-out (cE10) 59: PU time-out (cP10) 60: Brake chopper error (bF) 61-62: Reserved 63: Safety loop error (Sry) 64: Mechanical brake error (MBF) 65: PGF5 hardware error 66: Magnetic contactor error 67: Phase loss of drive output (MPHL)							
06-22	Fault Output Option 1	0-65535 (refer to bit table for fault code)	0	○	○	○	○	○	○
06-23	Fault Output Option 2	0-65535 (refer to bit table for fault code)	0	○	○	○	○	○	○
06-24	Fault Output Option 3	0-65535 (refer to bit table for fault code)	0	○	○	○	○	○	○
06-25	Fault Output Option 4	0-65535 (refer to bit table for fault code)	0	○	○	○	○	○	○
06-26	PTC (Positive Temperature Coefficient) Detection Selection	0: Warn and keep operation 1: Warn and ramp to stop	0	○	○	○	○	○	○
06-27	PTC Level	0.0~100.0%	50.0	○	○	○	○	○	○
06-28	Filter Time for PTC Detection	0.00~10.00sec	0.20	○	○	○	○	○	○
06-29	Voltage of Emergency Power	48.0~375.0Vdc 96.0~750.0Vdc	48.0 96.0	○	○	○	○	○	○
06-30	Setting Method of Fault Output	0: By settings of Pr.06-22~06-25 1: By the binary setting	0	○	○	○	○	○	○

Pr.	Explanation	Settings	Factory Setting	VF	VFG	SVC	FOCPG	TOCPG	FOCPM
06-31	Phase Loss Detection of Drive Output at Start up(MPHL)	0: Disable 1: Enable	0	○	○	○	○	○	○
06-32	Accumulative Drive Power-on Time at the First Fault (min.)	00~1439	00	○	○	○	○	○	○
06-33	Accumulative Drive Power-on Time at the First Fault (day)	00~65535	00	○	○	○	○	○	○
06-34	Accumulative Drive Power-on Time at the Second Fault (min.)	00~1439	00	○	○	○	○	○	○
06-35	Accumulative Drive Power-on Time at the Second Fault (day)	00~65535	00	○	○	○	○	○	○
06-36	Accumulative Drive Power-on Time at the Third Fault (min.)	00~1439	00	○	○	○	○	○	○
06-37	Accumulative Drive Power-on Time at the Third Fault (day)	00~65535	00	○	○	○	○	○	○
06-38	Accumulative Drive Power-on Time at the Fourth Fault (min.)	00~1439	00	○	○	○	○	○	○
06-39	Accumulative Drive Power-on Time at the Fourth Fault (day)	00~65535	00	○	○	○	○	○	○
06-40	Accumulative Drive Power-on Time at the Fifth Fault (min.)	00~1439	00	○	○	○	○	○	○
06-41	Accumulative Drive Power-on Time at the Fifth Fault (day)	00~65535	00	○	○	○	○	○	○
06-42	Accumulative Drive Power-on Time at the Sixth Fault (min.)	00~1439	00	○	○	○	○	○	○
06-43	Accumulative Drive Power-on Time at the Sixth Fault (day)	00~65535	00	○	○	○	○	○	○
↗06-44	Operation Speed of Emergency Power Mode	0.00~400.00Hz	Read Only	○	○	○	○	○	○
↗06-45	Low-voltage Protection	0: Display Lv fault and coast to stop 1: Display Lv warn and coast to stop 2: Fan lock, fault and coast to stop 3: Fan lock, warn and coast to stop	0	○	○	○	○	○	○
↗06-46	Operation Direction for Emergency Power ON	0: Operate by current command 1: Operate by the direction of power generating mode	0	○	○	○	○	○	○
↗06-47	Power Generation Direction Searching Time	0.0~5.0 sec	1.0	○	○	○	○	○	○
↗06-48	Power Capacity of Emergency Power	0.0~100.0 kVA	0.0	○	○	○	○	○	○

4.1.8 Group 7 Special Parameters

Pr.	Explanation	Settings	Factory Setting	VF	VFPF	SVC	FOCFG	TOCFM	FOCFM
↯07-00	Brake Chopper Level	230V: 350.0~450.0Vdc 460V: 700.0~900.0Vdc	380.0 760.0	○	○	○	○	○	○
07-01	Reserved								
↯07-02	DC Brake Current Level	0~100%	0	○	○	○			
↯07-03	DC Brake Activation Time	0.0~60.0 sec	0.0	○	○	○			○
↯07-04	DC Brake Stopping Time	0.0~60.0 sec	0.0	○	○	○			○
↯07-05	Start-point for DC Brake	0.00~400.00Hz	0.00	○	○	○			
↯07-06	DC Brake Proportional Gain	1~500Hz	50	○	○	○			
↯07-07	Dwell Time at Accel.	0.00~600.00sec	0.00						○
↯07-08	Dwell Frequency at Accel.	0.00~400.00Hz	0.00	○	○	○			○
↯07-09	Dwell Time at Decel.	0.00~600.00sec	0.00	○	○	○			○
↯07-10	Dwell Frequency at Decel.	0.00~400.00Hz	0.00	○	○	○			○
↯07-11	Fan Control	0: Fan always ON 1: 1 minute after AC motor drive stops, fan will be OFF 2: AC motor drive runs and fan ON, AC motor drive stops and fan OFF 3: Fan ON to run when preliminary heat sink temperature attained 4: Fan always OFF	2	○	○	○	○	○	○
↯07-12	Torque Command	-100.0~100.0% (Pr. 07-14 setting=100%)	0.0						○
↯07-13	Torque Command Source	0: Digital keypad (KPVLC-CC01) 1: RS485 serial communication (RJ-11) 2: Analog signal (Pr.03-00)	2						○
↯07-14	Maximum Torque Command	0~300%	100	○	○	○	○	○	○
↯07-15	Filter Time of Torque Command	0.000~1.000 sec	0.000						○
07-16	Speed Limit Selection	0: By Pr.07-17 and Pr.07-18 1: Frequency command source (Pr.00-14)	0						○
↯07-17	Torque Mode +Speed Limit	0~120%	10						○
↯07-18	Torque Mode-Speed Limit	0~120%	10						○
↯07-19	Source of Torque Offset	0: Disable 1: Analog input (Pr.03-00) 2: Torque offset setting (Pr.07-20) 3: Control by external terminal (by Pr.07-21 to Pr.07-23)	0			○	○	○	○
↯07-20	Torque Offset Setting	0.0~100.0%	0.0			○	○	○	○
↯07-21	High Torque Offset	0.0~100.0%	30.0			○	○	○	○
↯07-22	Middle Torque Offset	0.0~100.0%	20.0			○	○	○	○
↯07-23	Low Torque Offset	0.0~100.0%	10.0			○	○	○	○
↯07-24	Forward Motor Torque Limit	0~300%	200			○	○	○	○
↯07-25	Forward Regenerative Torque Limit	0~300%	200			○	○	○	○
↯07-26	Reverse Motor Torque Limit	0~300%	200			○	○	○	○
↯07-27	Reverse Regenerative Torque Limit	0~300%	200			○	○	○	○
↯07-28	Emergency Stop (EF) & Forced Stop Selection	0: Coast to stop 1: By deceleration Time 1 2: By deceleration Time 2 3: By deceleration Time 3 4: By deceleration Time 4 5: By Pr.01-31	0	○	○	○	○	○	○
↯07-29	Time for Decreasing Torque at Stop	0.000~1.000 sec	0.000				○	○	○

4.1.9 Group 8 PM Parameters

Pr.	Explanation	Settings	Factory Setting	V/F	V/PG	SVC	FO/PG	TO/PG	FO/PM
08-00	Motor Auto Tuning	0: No function 1: Only for the unloaded motor, auto measure the angle between magnetic pole and PG origin (08-09) 2: For PM parameters 3: Auto measure the angle between magnetic pole and PG origin (08-09)	0						<input type="radio"/>
08-01	Full-load Current of Motor	(40-120%)*00-01 Amps	###						<input type="radio"/>
08-02	Rated power of Motor	0.00~655.35 kW	###						<input type="radio"/>
08-03	Rated speed of Motor (rpm)	0~65535	1710						<input type="radio"/>
08-04	Number of Motor Poles	2~96	4						<input type="radio"/>
08-05	Rs of Motor	0.000~65.535Ω	0.000						<input type="radio"/>
08-06	Ld of Motor	0.0~6553.5mH	0.0						<input type="radio"/>
08-07	Lq of Motor	0.0~6553.5mH	0.0						<input type="radio"/>
08-08	Back Electromotive Force	0.0~6553.5Vrms	0.0						<input type="radio"/>
08-09	Angle between Magnetic Pole and PG Origin	0.0-360.0°	360.0						<input type="radio"/>
08-10	Magnetic Pole Re-orientation	0: Disable 1: Enable	0						<input type="radio"/>

4.1.10 Group 9 Communication Parameters

Pr.	Explanation	Settings	Factory Setting	VF	VFPG	SVC	FOCPG	TOCPG	FOCPM
↗09-00	Communication Address	1~254	1	<input type="radio"/>	<input type="radio"/>	<input type="radio"/>	<input type="radio"/>	<input type="radio"/>	<input type="radio"/>
↗09-01	Transmission Speed	4.8~115.2Kbps	9.6	<input type="radio"/>	<input type="radio"/>	<input type="radio"/>	<input type="radio"/>	<input type="radio"/>	<input type="radio"/>
↗09-02	Transmission Fault Treatment	0: Warn and keep operation 1: Warn and ramp to stop 2: Reserved 3: No action and no display	3	<input type="radio"/>	<input type="radio"/>	<input type="radio"/>	<input type="radio"/>	<input type="radio"/>	<input type="radio"/>
↗09-03	Time-out Detection	0.0~100.0 sec	0.0	<input type="radio"/>	<input type="radio"/>	<input type="radio"/>	<input type="radio"/>	<input type="radio"/>	<input type="radio"/>
↗09-04	Communication Protocol	0: 7N1 (ASCII) 1: 7N2 (ASCII) 2: 7E1 (ASCII) 3: 7O1 (ASCII) 4: 7E2 (ASCII) 5: 7O2 (ASCII) 6: 8N1 (ASCII) 7: 8N2 (ASCII) 8: 8E1 (ASCII) 9: 8O1 (ASCII) 10: 8E2 (ASCII) 11: 8O2 (ASCII) 12: 8N1 (RTU) 13: 8N2 (RTU) 14: 8E1 (RTU) 15: 8O1 (RTU) 16: 8E2 (RTU) 17: 8O2 (RTU)	13	<input type="radio"/>	<input type="radio"/>	<input type="radio"/>	<input type="radio"/>	<input type="radio"/>	<input type="radio"/>
↗09-05	Response Delay Time	0.0~200.0ms	2.0	<input type="radio"/>	<input type="radio"/>	<input type="radio"/>	<input type="radio"/>	<input type="radio"/>	<input type="radio"/>

4.1.11 Group 10 Speed Feedback Control Parameters

Pr.	Explanation	Settings	Factory Setting	VF	VFG	SVC	FOCPG	TOCPG	FOCPM
10-00	PG Signal Type	0: No function 1: ABZ 2: ABZ+Hall 3: SIN/COS+Sinusoidal 4: SIN/COS+Endat 5: SIN/COS 6: SIN/COS + Hiperface	0						
10-01	Encoder Pulse	1~20000	600						
10-02	Encoder Input Type Setting	0: Disable 1: Phase A leads in a forward run command and phase B leads in a reverse run command 2: Phase B leads in a forward run command and phase A leads in a reverse run command 3: Phase A is a pulse input and phase B is a direction input. (low input=reverse direction, high input=forward direction) 4: Phase A is a pulse input and phase B is a direction input. (low input=forward direction, high input=reverse direction) 5: Single-phase input	0						
↗10-03	Encoder Feedback Fault Treatment (PGF1, PGF2)	0: Warn and keep operation 1: Warn and ramp to stop 2: Warn and stop operation	2						
↗10-04	Detection Time for Encoder Feedback Fault	0.00~10.0 sec	1.0						
↗10-05	Encoder Stall Level (PGF3)	0~120% (0: disable)	115						
↗10-06	Encoder Stall Detection Time	0.0~2.0 sec	0.1						
↗10-07	Encoder Slip Range (PGF4)	0~50% (0: disable)	50						
↗10-08	Encoder Slip Detection Time	0.0~10.0 sec	0.5						
↗10-09	Encoder Stall and Slip Error Treatment	0: Warn and keep operation 1: Warn and ramp to stop 2: Warn and coast to stop	2						
10-10	Mode Selection for UVW Input	0: Z signal is at the falling edge of U-phase 1: Z signal is at the rising edge of U-phase	0						
↗10-11	ASR (Auto Speed Regulation) Control (P) of Zero Speed	0.0~500.0%	100.0						
↗10-12	ASR (Auto Speed Regulation) Control (I) of Zero Speed	0.000~10.000 sec	0.100						
↗10-13	ASR (Auto Speed Regulation) Control (P) 1	0.0~500.0%	100.0						
↗10-14	ASR (Auto Speed Regulation) Control (I) 1	0.000~10.000 sec	0.100						
↗10-15	ASR (Auto Speed Regulation) Control (P) 2	0.0~500.0%	100.0						
↗10-16	ASR (Auto Speed Regulation) Control (I) 2	0.000~10.000 sec	0.100						
↗10-17	ASR 1/ASR2 Switch Frequency	0.00~400.00Hz (0: disable)	7.00						
↗10-18	ASR Primary Low Pass Filter Gain	0.000~0.350 sec	0.008						
↗10-19	Zero Speed Gain (P)	0~655.00%e	80.00						
↗10-20	Zero Speed/ASR1 Width Adjustment	0.0~400.00Hz	5.00						
↗10-21	ASR1/ASR2 Width Adjustment	0.0~400.00Hz	5.00						
↗10-22	Zero speed Position Holding Time	0.000~65.535 sec	0.250						
↗10-23	Filter Time at Zero Speed	0.000~65.535 sec	0.004						
↗10-24	Time for Executing Zero Speed	0: after the brake release set in Pr.02-29 1: after the brake signal input (Pr.02-01~02-08 is set to 42)	0						
↗10-25	Elevator Leveling (Zero	0~1000.0%	100.0						

Chapter 4 Parameters | VFD-VL

Pr.	Explanation	Settings	Factory Setting	VF	VFPG	SWC	FOCPG	TOCPG	FOCPM
	Speed Gain P)								
↗10-26	Elevator Leveling (Zero Speed Integral I)	0~10.000 sec	0.100	<input type="checkbox"/>	<input type="checkbox"/>	<input type="checkbox"/>	<input type="checkbox"/>	<input type="checkbox"/>	<input type="checkbox"/>
↗10-27	Elevator Starts (Zero Speed Gain P)	0~1000.0%	100.0	<input type="checkbox"/>	<input type="checkbox"/>	<input type="checkbox"/>	<input type="checkbox"/>	<input type="checkbox"/>	<input type="checkbox"/>
↗10-28	Elevator Starts (Zero Speed Integral I)	0~10.000 sec	0.100	<input type="checkbox"/>	<input type="checkbox"/>	<input type="checkbox"/>	<input type="checkbox"/>	<input type="checkbox"/>	<input type="checkbox"/>

4.1.12 Group 11 Advanced Parameters

Pr.	Explanation	Settings	Factory Setting	VF	VFP	SVC	FOCPG	TOCPG	FOCPM
↗11-00	System Control	Bit 0=0: no function Bit 0=1: ASR Auto tuning, PDFF enable Bit 7=0: no function Bit 7=1: When position control is enabled, it doesn't need to set Pr.07-02 (DC Brake Current Level) Bit 15=0: when power is applied, it will detect the position of magnetic pole again Bit 15=1: when power is applied, it will start from the magnetic pole position of previous power failure	0				<input type="radio"/>		<input type="radio"/>
↗11-01	Elevator Speed	0.10~4.00 m/s	1.00				<input type="radio"/>		<input type="radio"/>
↗11-02	Sheave Diameter	100~2000 mm	400				<input type="radio"/>		<input type="radio"/>
↗11-03	Mechanical Gear Ratio	1~100	1				<input type="radio"/>		<input type="radio"/>
↗11-04	Suspension Ratio	0: 1:1 1: 2:1	1				<input type="radio"/>		<input type="radio"/>
↗11-05	Inertial Ratio	1~300%	40				<input type="radio"/>		<input type="radio"/>
↗11-06	Zero-speed Bandwidth	0~40Hz	10				<input type="radio"/>		<input type="radio"/>
↗11-07	Low-speed Bandwidth	0~40Hz	10				<input type="radio"/>		<input type="radio"/>
↗11-08	High-speed Bandwidth	0~40Hz	10				<input type="radio"/>		<input type="radio"/>
↗11-09	PDFF Gain Value	0~200%	30				<input type="radio"/>		<input type="radio"/>
↗11-10	Gain for Speed Feed Forward	0~500	0				<input type="radio"/>		<input type="radio"/>
↗11-11	Notch Filter Depth	0~20db	0				<input type="radio"/>		<input type="radio"/>
↗11-12	Notch Filter Frequency	0.00~200.00Hz	0.00				<input type="radio"/>		<input type="radio"/>
↗11-13	Low-pass Filter Time of Keypad Display	0.001~65.535s	0.500	<input type="radio"/>	<input type="radio"/>	<input type="radio"/>	<input type="radio"/>	<input type="radio"/>	<input type="radio"/>
↗11-14	Motor Current at Accel.	50~200%	150						<input type="radio"/>
↗11-15	Elevator Acceleration	0.20~2.00m/s ²	0.75						<input type="radio"/>
11-16	Reserved								
11-17	Reserved								
11-18	Reserved								

4.1.13 Group 12 User-defined Parameters

User-defined Parameters with range from group 00 to 11

∇: The parameter can be set during operation.

Pr.	Explanation (Default Function)	Settings	VF	VFPG	SVC	FOCPG	TOCPG	FOCPM
∇12-00	Present Fault Record	0610	<input type="checkbox"/>	<input type="checkbox"/>	<input type="checkbox"/>	<input type="checkbox"/>	<input type="checkbox"/>	<input type="checkbox"/>
∇12-01	Present Fault Time of Motor Operation (min.)	0620	<input type="checkbox"/>	<input type="checkbox"/>	<input type="checkbox"/>	<input type="checkbox"/>	<input type="checkbox"/>	<input type="checkbox"/>
∇12-02	Present Fault Time of Motor Operation (day)	0621	<input type="checkbox"/>	<input type="checkbox"/>	<input type="checkbox"/>	<input type="checkbox"/>	<input type="checkbox"/>	<input type="checkbox"/>
∇12-03	Frequency Command at Present Fault	2120	<input type="checkbox"/>	<input type="checkbox"/>	<input type="checkbox"/>	<input type="checkbox"/>	<input type="checkbox"/>	<input type="checkbox"/>
∇12-04	Output Frequency at Present Fault	2121	<input type="checkbox"/>	<input type="checkbox"/>	<input type="checkbox"/>	<input type="checkbox"/>	<input type="checkbox"/>	<input type="checkbox"/>
∇12-05	Output Current at Present Fault	2122	<input type="checkbox"/>	<input type="checkbox"/>	<input type="checkbox"/>	<input type="checkbox"/>	<input type="checkbox"/>	<input type="checkbox"/>
∇12-06	Motor Frequency at Present Fault	2123	<input type="checkbox"/>	<input type="checkbox"/>	<input type="checkbox"/>	<input type="checkbox"/>	<input type="checkbox"/>	<input type="checkbox"/>
∇12-07	Output Voltage at Present Fault	2124	<input type="checkbox"/>	<input type="checkbox"/>	<input type="checkbox"/>	<input type="checkbox"/>	<input type="checkbox"/>	<input type="checkbox"/>
∇12-08	DC-Bus Voltage at Present Fault	2125	<input type="checkbox"/>	<input type="checkbox"/>	<input type="checkbox"/>	<input type="checkbox"/>	<input type="checkbox"/>	<input type="checkbox"/>
∇12-09	Output Power at Present Fault	2126	<input type="checkbox"/>	<input type="checkbox"/>	<input type="checkbox"/>	<input type="checkbox"/>	<input type="checkbox"/>	<input type="checkbox"/>
∇12-10	Output Torque at Present Fault	2127	<input type="checkbox"/>	<input type="checkbox"/>	<input type="checkbox"/>	<input type="checkbox"/>	<input type="checkbox"/>	<input type="checkbox"/>
∇12-11	IGBT Temperature of Power Module at Present Fault	2128	<input type="checkbox"/>	<input type="checkbox"/>	<input type="checkbox"/>	<input type="checkbox"/>	<input type="checkbox"/>	<input type="checkbox"/>
∇12-12	Multi-function Terminal Input Status at Present Fault	2129	<input type="checkbox"/>	<input type="checkbox"/>	<input type="checkbox"/>	<input type="checkbox"/>	<input type="checkbox"/>	<input type="checkbox"/>
∇12-13	Multi-function Terminal Output Status at Present Fault	212A	<input type="checkbox"/>	<input type="checkbox"/>	<input type="checkbox"/>	<input type="checkbox"/>	<input type="checkbox"/>	<input type="checkbox"/>
∇12-14	Drive Status at Present Fault	212B	<input type="checkbox"/>	<input type="checkbox"/>	<input type="checkbox"/>	<input type="checkbox"/>	<input type="checkbox"/>	<input type="checkbox"/>
∇12-15	Second Most Recent Fault Record	0611	<input type="checkbox"/>	<input type="checkbox"/>	<input type="checkbox"/>	<input type="checkbox"/>	<input type="checkbox"/>	<input type="checkbox"/>
∇12-16	Second Most Recent Fault Time of Motor Operation (min.)	0622	<input type="checkbox"/>	<input type="checkbox"/>	<input type="checkbox"/>	<input type="checkbox"/>	<input type="checkbox"/>	<input type="checkbox"/>
∇12-17	Second Most Recent Fault Time of Motor Operation (day)	0623	<input type="checkbox"/>	<input type="checkbox"/>	<input type="checkbox"/>	<input type="checkbox"/>	<input type="checkbox"/>	<input type="checkbox"/>
∇12-18	Third Most Recent Fault Record	0612	<input type="checkbox"/>	<input type="checkbox"/>	<input type="checkbox"/>	<input type="checkbox"/>	<input type="checkbox"/>	<input type="checkbox"/>
∇12-19	Third Most Recent Fault Time of Motor Operation (min.)	0624	<input type="checkbox"/>	<input type="checkbox"/>	<input type="checkbox"/>	<input type="checkbox"/>	<input type="checkbox"/>	<input type="checkbox"/>
∇12-20	Third Most Recent Fault Time of Motor Operation (day)	0625	<input type="checkbox"/>	<input type="checkbox"/>	<input type="checkbox"/>	<input type="checkbox"/>	<input type="checkbox"/>	<input type="checkbox"/>
∇12-21	Fourth Most Recent Fault Record	0613	<input type="checkbox"/>	<input type="checkbox"/>	<input type="checkbox"/>	<input type="checkbox"/>	<input type="checkbox"/>	<input type="checkbox"/>
∇12-22	Fourth Most Recent Fault Time of Motor Operation (min.)	0626	<input type="checkbox"/>	<input type="checkbox"/>	<input type="checkbox"/>	<input type="checkbox"/>	<input type="checkbox"/>	<input type="checkbox"/>
∇12-23	Fourth Most Recent Fault Time of Motor Operation (day)	0627	<input type="checkbox"/>	<input type="checkbox"/>	<input type="checkbox"/>	<input type="checkbox"/>	<input type="checkbox"/>	<input type="checkbox"/>
∇12-24	Fifth Most Recent Fault Record	0614	<input type="checkbox"/>	<input type="checkbox"/>	<input type="checkbox"/>	<input type="checkbox"/>	<input type="checkbox"/>	<input type="checkbox"/>
∇12-25	Fifth Most Recent Fault Time of Motor Operation (min.)	0628	<input type="checkbox"/>	<input type="checkbox"/>	<input type="checkbox"/>	<input type="checkbox"/>	<input type="checkbox"/>	<input type="checkbox"/>
∇12-26	Fifth Most Recent Fault Time of Motor Operation (day)	0629	<input type="checkbox"/>	<input type="checkbox"/>	<input type="checkbox"/>	<input type="checkbox"/>	<input type="checkbox"/>	<input type="checkbox"/>
∇12-27	Sixth Most Recent Fault Record	0615	<input type="checkbox"/>	<input type="checkbox"/>	<input type="checkbox"/>	<input type="checkbox"/>	<input type="checkbox"/>	<input type="checkbox"/>
∇12-28	Sixth Most Recent Fault Time of Motor Operation (min.)	062A	<input type="checkbox"/>	<input type="checkbox"/>	<input type="checkbox"/>	<input type="checkbox"/>	<input type="checkbox"/>	<input type="checkbox"/>
∇12-29	Sixth Most Recent Fault Time of Motor Operation (day)	062B	<input type="checkbox"/>	<input type="checkbox"/>	<input type="checkbox"/>	<input type="checkbox"/>	<input type="checkbox"/>	<input type="checkbox"/>
∇12-30	No Factory Setting							
∇12-31	No Factory Setting							

4.1.14 Group 13 View User-defined Parameters

Pr.	Explanation	Settings	Factory Setting	VF	VFFG	SVC	FDCPG	TOCPG	FOCPM
13-00 13-31	View User-defined Parameters	Pr.00-00 to Pr.11-18	-	<input type="radio"/>	<input type="radio"/>	<input type="radio"/>	<input type="radio"/>	<input type="radio"/>	<input type="radio"/>

4.2 Description of Parameter Settings

4.2.1 Group 0 User Parameters

✎: This parameter can be set during operation.

00-00	Identity Code of the AC Motor Drive							Factory setting: ##
Control mode	VF	VFPG	SVC	FOCPG	TQCPG	FOCPM		
	Settings		Read Only					
00-01	Rated Current Display of the AC Motor Drive							Factory setting: ##
Control mode	VF	VFPG	SVC	FOCPG	TQCPG	FOCPM		
	Settings		Read Only					

 Pr. 00-00 displays the identity code of the AC motor drive. The capacity, rated current, rated voltage and the max. carrier frequency relate to the identity code. Users can use the following table to check how the rated current, rated voltage and max. carrier frequency of the AC motor drive correspond to the identity code.

 Pr.00-01 displays the rated current of the AC motor drive. By reading this parameter the user can check if the AC motor drive is correct.

	230V Series							
kW	5.5	7.5	11	15	18.5	22	30	37
HP	7.5	10	15	20	25	30	40	50
Pr.00-00	12	14	16	18	20	22	24	26
Rated Output Current for General Purposes (A)	21.9	27.1	41	53	70	79	120	146
Rated Output Current for Elevators (A)	25	31	47	60	80	90	150	183
Max. Carrier Frequency	15kHz						9kHz	

	460V Series										
kW	5.5	7.5	11	15	18.5	22	30	37	45	55	75
HP	7.5	10	15	20	25	30	40	50	60	75	100
Pr.00-00	13	15	17	19	21	23	25	27	29	31	33
Rated Output Current for General Purposes (A)	12.3	15.8	21	27	34	41	60	73	91	110	150
Rated Output Current for Elevators (A)	14	18	24	31	39	47	75	91	113	138	188
Max. Carrier Frequency	15kHz						9kHz			6kHz	

00-02 Parameter Reset

Control mode	VF	VFPG	SVC	FOCPG	TQCPG	FOCPM	Factory setting: 0
Settings	0	No Function					
	1	Read Only					
	8	Keypad Lock					
	9	All parameters are reset to factory settings (50Hz, 220V/380V)					
	10	All parameters are reset to factory settings (60Hz, 220V/440V)					

 When it is set to 1, all parameters are read only except Pr.00-00~00-07 and it can be used with password setting for password protection.

 This parameter allows the user to reset all parameters to the factory settings except the fault records (Pr.06-16 ~ Pr.06-21).

50Hz: Pr.01-01 is set to 50Hz and Pr.01-02 is set to 230V or 400V.

60Hz: Pr.01-01 is set to 60Hz and Pr.01-02 is set to 230V or 460V.

 When Pr.00-02=08, the KPVL-CC01 keypad is locked and only Pr.00-02 can be set. To unlock the keypad, set Pr.00-02=00.

 When Pr.00-02 is set to 1, Pr.00-02 setting should be set to 0 before setting to other setting.

00-03  Start-up Display Selection

Control mode	VF	VFPG	SVC	FOCPG	TQCPG	FOCPM	Factory setting: 0
Settings	0	Display the frequency command value. (LED F)					
	1	Display the actual output frequency (LED H)					
	2	DC BUS voltage					
	3	Display the output current (A)					
	4	Output voltage					
	5	Multifunction display, see Pr.00-04					

 This parameter determines the start-up display page after power is applied to the drive.

00-04  Content of Multi-Function Display

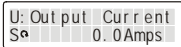
Control mode	VF	VFPG	SVC	FOCPG	TQCPG	FOCPM	Factory setting: 0
Settings	0	Display the output current in A supplied to the motor					
	1	Reserved					

2	Display actual output frequency (H)	U: Actual Freq. Sa 0.00Hz
3	Display the actual DC BUS voltage in VDC of the AC motor drive	U: DC BUS Sa 255.3Vot
4	Display the output voltage in VAC of terminals U, V, W to the motor.	U: Output Voltage Sa 0.0Vot
5	Display the power factor angle in ° of terminals U, V, W to the motor.	U: Power Angle Sa 0.0deg
6	Display the output power in kW of terminals U, V and W to the motor.	U: Output Power Sa 0.000KW
7	Display the actual motor speed in rpm (enabled when using with PG card).	U: Motor Speed Sa 0RPM
8	Display the estimated value of torque in % as it relates to current.	U: Torque Sa 0.0%
9	Display PG position	U: PG Feedback Sa 1567
10	Display the electrical angle of drive output	U: Electric Angle Sa XXX.Xdeg
11	Display the signal of AUI1 analog input terminal in %. Range 0~10V corresponds to 0~100%. (1.)	U: AUI 1 Sa 0.3%
12	Display the signal of ACI analog input terminal in %. Range 4~20mA/0~10V corresponds to 0~100%. (2.)	U: ACI Sa 0.0%
13	Display the signal of AUI2 analog input terminal in %. Range -10V~10V corresponds to 0~100%. (3.)	U: AUI 2 Sa 0.3%
14	Display the temperature of heat sink (°C)	U: Heat Sink Sa 0.0 C
15	Display the temperature of IGBT in °C.	U: IGBT Temp Sa 41.3 C
16	Display digital input status ON/OFF (i)	U: DI ON/OFF St at Sa 0000
17	Display digital output status ON/OFF (o)	U: DO ON/OFF St at Sa 0000
18	Display multi-step speed	U: Multi-Speed Sa 0

00-04 Content of Multi-Function Display

19 The corresponding CPU pin status of digital input (i.)

U: DI	Pin	Status
Se		FFFF

20 The corresponding CPU pin status of digital output (o.)

U: DO	Pin	Status
Se		FFFF

21

| Reserved

23

24 Output AC voltage when malfunction (8)

U: Error	Vout
Se	0.0Vac

25 Output DC voltage when malfunction (8.)

U: Error	Vbus
Se	256.4Vdc

26 Motor frequency when malfunction (h)

U: Error	Fbk
Se	0.00Hz

27 Output current when malfunction (4)

U: Error	Current
Se	0.00Amps

28 Output frequency when malfunction (h.)

U: Error	Fout
Se	0.00Hz

29 Frequency command when malfunction

U: Error	Fcmd
Se	0.00Amps

30 Output power when malfunction

U: Error	Power
Se	0.00KW

31 Output torque when malfunction

U: Error	Torque
Se	0.00%

32 Input terminal status when malfunction

U: Error	DI State
Se	0000Hex

33 Output terminal status when malfunction

U: Error	DO State
Se	0000Hex

34 Drive status when malfunction

U: Error	Drive
Se	0000Hex

 It is used to display the content when LED U is ON. It is helpful for getting the AC motor drive's status by this parameter.

U: DI	ON/ OFF	Status
Se		0086

Terminal	MI8	MI7	MI6	MI5	MI4	MI3	MI2	MI1	REV	FWD
Status	0	0	1	0	0	0	0	1	1	0

0: OFF, 1: ON

MI1: Pr.02-01 is set to 1 (multi-step speed command 1)

MI8: Pr.02-08 is set to 8 (the 1st, 2nd acceleration/deceleration time selection)

If REV, MI1 and MI8 are ON, the value is 0000 0000 1000 0110₂ in binary and 0086H in HEX.

At the meanwhile, if Pr.00-04 is set to "14" or "17", it will display "0086" with LED U is ON on the keypad KPVL-CC01. The setting 14 is the status of digital input and the setting 17 is the corresponding CPU pin status of digital input. User can set to 14 to monitor digital input status and then set to 17 to check if the wire is normal.

U: DO ON/ OFF St at
S_a 0001

Terminal	MO10	MO9	MO8	MO7	MO6	MO5	MO4	MO3	MO2	MO1	MRA	RA	MO10
Status	0	0	0	0	1	0	0	0	0	1	1	0	0

RA: Pr.02-11 is set to 9 (Drive ready).

After applying the power to the AC motor drive, if there is no other abnormal status, the contact will be ON. At the meanwhile, if Pr.00-04 is set to 15 or 18, it will display 0001 with LED U is ON on the keypad. The setting 15 is the status of digital output and the setting 18 is the corresponding CPU pin status of digital output. User can set 15 to monitor the digital output status and then set to 18 to check if the wire if normal.

00-05 User Defined Coefficient K

Control mode VF VFPG SVC FOC_{PG} TQCPG FOC_{PM} Factory setting: 0

Settings Digit 4: decimal point number (0 to 3)

Digit 0-3: 40 to 9999



It is used digital setting method

Digital 4: decimal point number (0: no decimal point, 1: 1 decimal point and so on.)

Digit 0-3: 40 to 9999 (the corresponding value for the max. frequency).



User Coefficient
S_a 00000

corresponding value
decimal point number

-  For example, if use uses rpm to display the motor speed and the corresponding value to the 4-pole motor 60Hz is 1800. This parameter can be set to 01800 to indicate that the corresponding value for 60Hz is 1800rpm. If the unit is rps, it can be set 10300 to indicate the corresponding value for 60Hz is 30.0 (a decimal point).
-  Only frequency setting can be displayed by the corresponding value.
-  After setting Pr.00-05, it won't display the unit of frequency "Hz" after returning to the main menu.

00-06		Software Version					Factory setting: Read Only
Control mode	VF	VFPG	SVC	FOCPG	TQCPG	FOCPM	
	Settings	Read Only					
	Display	#.##					

00-07		Password Input					Factory setting: 0
Control mode	VF	VFPG	SVC	FOCPG	TQCPG	FOCPM	
	Settings	1 to 9998 and 10000 to 65535					
	Display	0~2 (times of wrong password)					

-  The function of this parameter is to input the password that is set in Pr.00-08. Input the correct password here to enable changing parameters. You are limited to a maximum of 3 attempts. After 3 consecutive failed attempts, a fault code "Password Error" will show up to force the user to restart the AC motor drive in order to try again to input the correct password.
-  When forgetting password, you can decode by setting 9999 and press button  twice. Please note that all the settings will be set to factory setting.

00-08		Password Set					Factory setting: 0
Control mode	VF	VFPG	SVC	FOCPG	TQCPG	FOCPM	
	Settings	1 to 9998 and 10000 to 65535					
	Display	0	No password set or successful input in Pr. 00-07				
		1	Password has been set				

-  To set a password to protect your parameter settings. If the display shows 0, no password is set or password has been correctly entered in Pr.00-07. All parameters can then be changed, including Pr.00-08.

The first time you can set a password directly. After successful setting of password the display will show 1.

Be sure to record the password for later use.

To cancel the parameter lock, set the parameter to 0 after inputting correct password into Pr. 00-07.

The password consists of min. 2 digits and max. 5 digits.

 How to make the password valid again after decoding by Pr.00-07:

Method 1: Re-input original password into Pr.00-08 (Or you can enter a new password if you want to use a changed or new one).

Method 2: After rebooting, password function will be recovered.

Password Decode Flow Chart

Password Setting

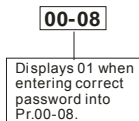

Decoding Flow Chart

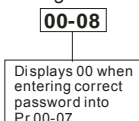

Forgetting Password

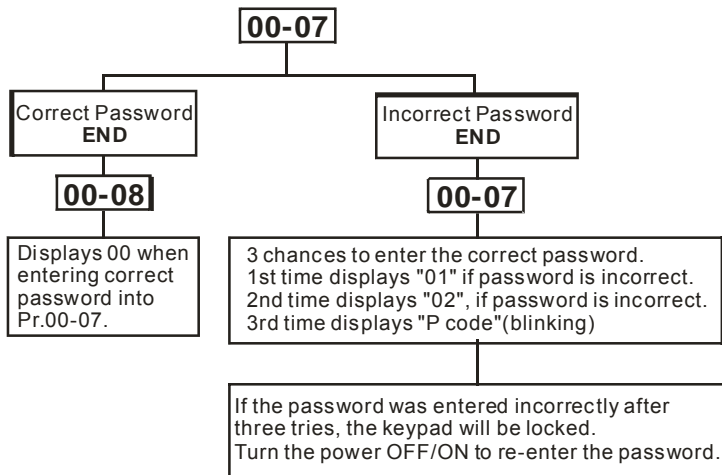
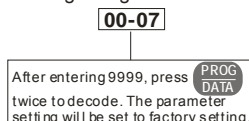

00-12 Carrier Frequency

Control mode VF VFPG SVC FOC PG TQCPG FOC PM

Factory setting: 12

Settings 2~15KHz

This parameter determines the PWM carrier frequency of the AC motor drive.

230V/460V Series				
Models	7.5-15HP 5.5-11kW	20-30HP 15-22kW	40-60 HP 30-45kW	40-100HP 30-75kW
Setting Range	2~15kHz	2~15kHz	02-09kHz	02~15kHz
Factory Setting	12kHz	9kHz	6kHz	6kHz

Carrier Frequency	Acoustic Noise	Electromagnetic Noise or Leakage Current	Heat Dissipation	Current Wave
2kHz	Significant ↓ Minimal	Minimal ↓ Significant	Minimal ↓ Significant	
8kHz				
15kHz				

From the table, we see that the PWM carrier frequency has a significant influence on the electromagnetic noise, AC motor drive heat dissipation, and motor acoustic noise.

00-13 Auto Voltage Regulation (AVR) Function

Control mode VF VFPG SVC FOC PG TQCPG FOC PM

Factory setting: 0

Settings 0 Enable AVR
1 Disable AVR
2 Disable AVR when deceleration stop

It is used to select the AVR mode. AVR is used to regulate the output voltage to the motor. For example, if V/f curve is set to AC200V/50Hz and the input voltage is from 200 to 264VAC, the output voltage won't exceed AC200V/50Hz. If the input voltage is from 180 to 200V, the output voltage to the motor and the input voltage will be in direct proportion.

When setting Pr.00-13 to 1 during ramp to stop and used with auto accel./decel. function, the acceleration will be smoother and faster.

00-14 Source of the Master Frequency Command



Control mode VF VFPG SVC FOC PG TQCPG FOC PM

Factory setting: 1

Settings 1 RS-485 serial communication or digital keypad (KPVL-CC01)
2 External analog input (Pr. 03-00)
3 Digital terminals input (Pr.04-00~04-15)

This parameter determines the drive's master frequency source.

00-15	↗ Source of the Operation Command						
Control mode	VF	VFPG	SVC	FOCPG	TQCPG	FOCPM	Factory setting: 1
	Settings		1	External terminals			
			2	RS-485 serial communication or digital keypad (KPVL-CC01)			

-  VFD-VL series is shipped without digital keypad and users can use external terminals or RS-485 to control the operation command.
-  When the LED PU is light, the operation command can be controlled by the optional digital keypad (KPVL-CC01). Refer to appendix B for details.

4.2.2 Group 1 Basic Parameters

01-00		Maximum Output Frequency					
Control mode	VF	VFPG	SVC	FOCPG	TQCPG	FOCPM	Factory setting: 60.00/50.00
	Settings	10.00 to 400.00Hz					

 This parameter determines the AC motor drive's Maximum Output Frequency. All the AC motor drive frequency command sources (analog inputs 0 to +10V, 4 to 20mA and -10V to +10V) are scaled to correspond to the output frequency range.

01-01		1st Output Frequency Setting					
Control mode	VF	VFPG	SVC	FOCPG	TQCPG	FOCPM	Factory setting: 60.00/50.00
	Settings	0.00~400.00Hz					

 It is for the base frequency and motor rated frequency.

 This value should be set according to the rated frequency of the motor as indicated on the motor nameplate. If the motor is 60Hz, the setting should be 60Hz. If the motor is 50Hz, it should be set to 50Hz.

01-02		1st Output Voltage Setting					
Control mode	VF	VFPG	SVC	FOCPG	TQCPG	FOCPM	Factory Setting: 220.0/440.0
	Settings	230V series	0.1 to 255.0V				
		460V series	0.1 to 510.0V				Factory Setting: 440.0

 It is for the base frequency and motor rated frequency.

 This value should be set according to the rated voltage of the motor as indicated on the motor nameplate. If the motor is 220V, the setting should be 220.0. If the motor is 200V, it should be set to 200.0.

 There are many motor types in the market and the power system for each country is also difference. The economic and convenience method to solve this problem is to install the AC motor drive. There is no problem to use with the different voltage and frequency and also can amplify the original characteristic and life of the motor.

01-03		2nd Output Frequency Setting					
Control mode	VF	VFPG					Factory setting: 0.50
	Settings	0.00~400.00Hz					

01-04	↗2nd Output Voltage Setting			
Control mode	VF	VFPG	Factory Setting: 5.0/10.0	
	Settings	230V series	0.1 to 255.0V	
		460V series	0.1 to 510.0V	Factory Setting: 10.0
01-05	3rd Output Frequency Setting			
Control mode	VF	VFPG	Factory setting: 0.50	
	Settings	0.00~400.00Hz		
01-06	↗3rd Output Voltage Setting			
Control mode	VF	VFPG	Factory Setting: 5.0/10.0	
	Settings	230V series	0.1 to 255.0V	
		460V series	0.1 to 510.0V	
01-07	4th Output Frequency Setting			
Control mode	VF	VFPG	SVC	FOCPG TQCPG
	Settings	0.00~400.00Hz		Factory Setting: 0.00
01-08	↗4th Output Voltage Setting			
Control mode	VF	VFPG	Factory Setting: 5.0/10.0	
	Settings	230V series	0.1 to 255.0V	
		460V series	0.1 to 510.0V	

 V/f curve setting is usually set by the motor's allowable loading characteristics. Pay special attention to the motor's heat dissipation, dynamic balance, and bearing lubricity, if the loading characteristics exceed the loading limit of the motor.

 For the V/f curve setting, it should be Pr.01-01 ≥ Pr.01-03 ≥ Pr.01-05 ≥ Pr.01-07. There is no limit for the voltage setting, but a high voltage at the low frequency may cause motor damage, overheat, stall prevention or over-current protection. Therefore, please use the low voltage at the low frequency to prevent motor damage.

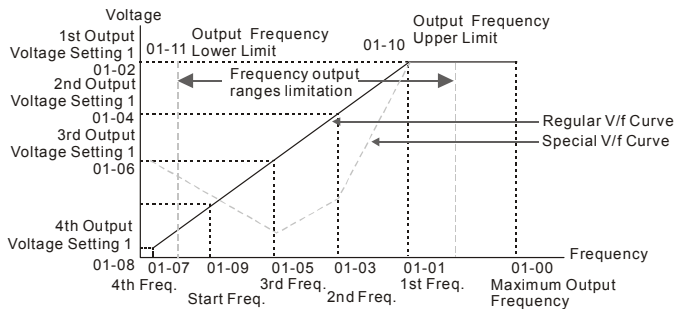

V/f Curve

01-09 Start Frequency

Control mode	VF	VFPG	SVC	FOCPG	Factory setting: 0.50
Settings	0.00~400.00Hz				

To distinguish which frequency should be start frequency, it needs to compare the value of min.

output frequency and start frequency. The larger value will be start frequency.

When min. output frequency > start frequency

When start frequency > min. output frequency

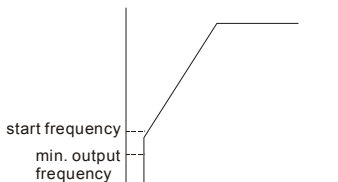
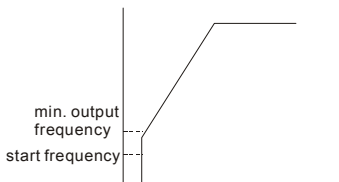

01-10 Output Frequency Upper Limit

Control mode	VF	VFPG	SVC	FOCPG	FOCPM	Factory setting: 120.00
Settings	0.00~400.00Hz					

01-11 Output Frequency Lower Limit





Control mode	VF	VFPG	SVC	FOCPG	FOCPM	Factory setting: 0.00
Settings	0.00~400.00Hz					

The upper/lower output frequency setting is used to limit the actual output frequency. If the frequency setting is lower than the start-up frequency, it will run with zero speed. If the frequency setting is higher than the upper limit, it will runs with the upper limit frequency. If output frequency lower limit > output frequency upper limit, this function is invalid.

01-12	✓ Accel. Time 1						
01-14	✓ Accel. Time 2						
01-16	✓ Accel. Time 3						
01-18	✓ Accel. Time 4						
Control mode	VF	VFPG	SVC	FOCPG	FOCPM		Factory setting: 3.00
	Settings		0.00~600.00 sec				

01-13	✓ Decel. Time 1						
01-15	✓ Decel. Time 2						
01-17	✓ Decel. Time 3						
01-19	✓ Decel. Time 4						
Control mode	VF	VFPG	SVC	FOCPG	FOCPM		Factory setting: 2.00
	Settings		0.00~600.00 sec				

01-20	✓ JOG Acceleration Time						
01-21	✓ JOG Deceleration Time						
Control mode	VF	VFPG	SVC	FOCPG	FOCPM		Factory setting: 1.00
	Settings		0.00~600.00 sec				

-  The Acceleration Time is used to determine the time required for the AC motor drive to ramp from 0Hz to Maximum Output Frequency (Pr.01-00).
-  The Deceleration Time is used to determine the time require for the AC motor drive to decelerate from the Maximum Output Frequency (Pr.01-00) down to 0Hz.
-  The Acceleration/Deceleration Time 1, 2, 3, 4 are selected according to the Multi-function Input Terminals settings. The factory settings are acceleration time 1 and deceleration time 1.
-  The larger against torque and inertia torque of the load and the accel./decel. time setting is less than the necessary value, it will enable torque limit and stall prevention function. When it happens, actual accel./decel. time will be longer than the action above.

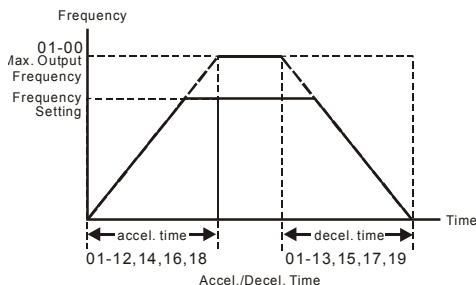
**01-22** JOG Frequency

Control mode	VF	VFP	SVC	FOCPG	TQCPG	FOCPM	Factory setting: 6.00
---------------------	----	-----	-----	-------	-------	-------	-----------------------

Settings	0.00~400.00Hz
----------	---------------

- Both external terminal JOG and key "JOG" on the keypad can be used. When the jog command is ON, the AC motor drive will accelerate from 0Hz to jog frequency (Pr.01-22). When the jog command is OFF, the AC motor drive will decelerate from Jog Frequency to zero. The used Accel./Decel. time is set by the Jog Accel./Decel. time (Pr.01-20, Pr.01-21).
- The JOG command can't be executed when the AC motor drive is running. In the same way, when the JOG command is executing, other operation commands are invalid except forward/reverse commands and STOP key on the digital keypad.

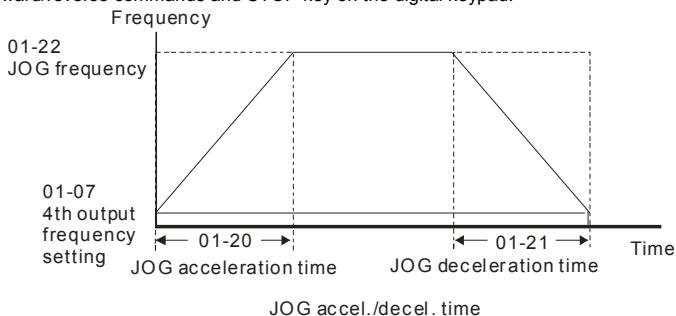
**01-23** Switch Frequency between 1st/4th Accel./decel

Control mode	VF	VFP	SVC	FOCPG	FOCPM	Factory setting: 0.00
---------------------	----	-----	-----	-------	-------	-----------------------

Settings	0.00~400.00Hz
----------	---------------

- 📖 This parameter selects the frequency point for transition from acceleration/deceleration time 1 to acceleration/deceleration time 4.
- 📖 The transition from acceleration/deceleration time 1 to acceleration/deceleration time 4, may also be enabled by the external terminals (Pr. 02-01 to 02-08). The external terminal has priority over Pr. 01-23.

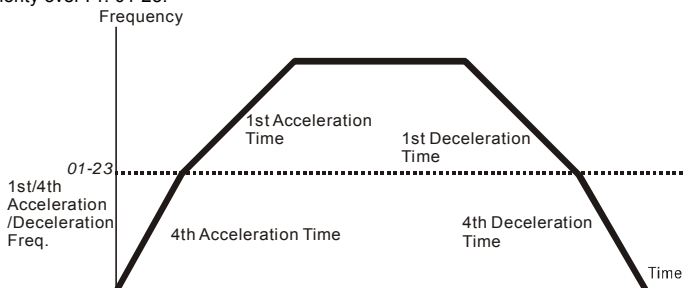

1st/4th Acceleration/Deceleration Switching

01-24	✓ S-curve for Acceleration Departure Time S1					
01-25	✓ S-curve for Acceleration Arrival Time S2					
01-26	✓ S-curve for Deceleration Departure Time S3					
01-27	✓ S-curve for Deceleration Arrival Time S4					
01-30	✓ S-curve for Deceleration Arrival Time S5					
Control mode	VF	VFPG	SVC	FOCPG	FOCPM	Factory setting: 1.00
	Settings 0.00~25.00 sec					
01-29	✓ Switch Frequency for S3/S4 Changes to S5					
Control mode	VF	VFPG	SVC	FOCPG	FOCPM	Factory setting: 0.00
	Settings 0.00~400.00Hz					

- 📖 It is used to give the smoothest transition between speed changes. The accel./decel. curve can adjust the S-curve of the accel./decel. When it is enabled, the drive will have different accel./decel. curve by the accel./decel. time.
- 📖 The Actual Accel. Time = selected accel. Time + (Pr.01-24 + Pr.01-25)/2
The Actual Decel. Time = selected decel. Time + (Pr.01-26 + Pr.01-27 + Pr.01-30*2)/2
- 📖 Pr.01-29 is used to set the switch frequency between S4 and S5 for smooth stop.
- 📖 It is recommended to set this parameter to the leveling speed of elevator.

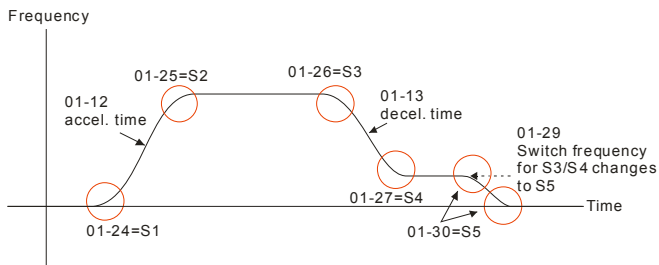

01-28 Mode Selection when Frequency < Fmin

Control mode	VF	VFPG	SVC	Factory setting: 1
Settings	0		Output Waiting	
	1		Zero-speed operation	
	2		Fmin (4th output frequency setting)	

When the AC motor drive is at 0Hz, it will operate by this parameter.

When it is set to 1 or 2, voltage will be output by Fmin corresponding output voltage(Pr.01-08).

01-31 Deceleration Time when Operating without RUN Command

Control mode	VF	VFPG	SVC	FOCPG	FOCPM	Factory setting: 2.00
Settings		0.00~600.00	Sec			

The AC motor drive will stop by the setting of this parameter when canceling RUN command. Refer to the figure in Pr.01-29 for details.

4.2.3 Group 2 Digital Input/Output Parameters

02-00	2-wire/3-wire Operation Control						Factory setting: 0
Control mode	VF	VFPG	SVC	FOCPG	TQCPG	FOCPM	
Settings		0	FWD/STOP, REV/STOP				
		1	FWD/STOP, REV/STOP (Line Start Lockout)				
		2	RUN/STOP, REV/FWD				
		3	RUN/STOP, REV/FWD (Line Start Lockout)				
		4	3-wire				
		5	3-wire (Line Start Lockout)				

Three of the six methods include a “Line Start Lockout” feature. When line start lockout is enabled, the drive will not run once applying the power. The Line Start Lockout feature doesn't guarantee the motor will never start under this condition. It is possible the motor may be set in motion by a malfunctioning switch.

This parameter is used to control operation from external terminals. There are three different control modes.

02-00	Control Circuits of the External Terminal	
0, 1 2-wire operation control (1) FWD/STOP REV/STOP		
2, 3 2-wire operation control (2) RUN/STOP REV/FWD		
4, 5 3-wire operation control		

02-01



Multi-Function Input Command 1 (MI1)
(it is Stop terminal for 3-wire operation)

Factory Setting: 1

02-02	Multi-Function Input Command 2 (MI2)	Factory Setting: 2
02-03	Multi-Function Input Command 3 (MI3)	Factory Setting: 3
02-04	Multi-Function Input Command 4 (MI4)	Factory Setting: 4
02-05	Multi-Function Input Command 5 (MI5)	Factory Setting: 0
02-06	Multi-Function Input Command 6 (MI6)	Factory Setting: 0
02-07	Multi-Function Input Command 7 (MI7)	Factory Setting: 0
02-08	Multi-Function Input Command 8 (MI8) When JP1 on the control board is inserted, MI8 functions acc. to Pr02-08. When JP1 on the control board is removed, MI8 is always "enable", independent of Pr02-08.	Factory Setting: 40
Settings 0-43		

Settings	Control Mode					
	VF	VFPG	SVC	FOCPG	TQCPG	FOCPM
0: no function	<input type="radio"/>	<input type="radio"/>	<input type="radio"/>	<input type="radio"/>	<input type="radio"/>	<input type="radio"/>
1: multi-step speed command 1	<input type="radio"/>	<input type="radio"/>	<input type="radio"/>	<input type="radio"/>	<input type="radio"/>	<input type="radio"/>
2: multi-step speed command 2	<input type="radio"/>	<input type="radio"/>	<input type="radio"/>	<input type="radio"/>	<input type="radio"/>	<input type="radio"/>
3: multi-step speed command 3	<input type="radio"/>	<input type="radio"/>	<input type="radio"/>	<input type="radio"/>	<input type="radio"/>	<input type="radio"/>
4: multi-step speed command 4	<input type="radio"/>	<input type="radio"/>	<input type="radio"/>	<input type="radio"/>	<input type="radio"/>	<input type="radio"/>
5: Reset	<input type="radio"/>	<input type="radio"/>	<input type="radio"/>	<input type="radio"/>	<input type="radio"/>	<input type="radio"/>
6: JOG command	<input type="radio"/>	<input type="radio"/>	<input type="radio"/>	<input type="radio"/>	<input type="radio"/>	<input type="radio"/>
7: acceleration/deceleration speed inhibit	<input type="radio"/>	<input type="radio"/>	<input type="radio"/>	<input type="radio"/>	<input type="radio"/>	<input type="radio"/>
8: the 1st, 2nd acceleration/deceleration time selection	<input type="radio"/>	<input type="radio"/>	<input type="radio"/>	<input type="radio"/>	<input type="radio"/>	<input type="radio"/>
9: the 3rd, 4th acceleration/deceleration time selection	<input type="radio"/>	<input type="radio"/>	<input type="radio"/>	<input type="radio"/>	<input type="radio"/>	<input type="radio"/>
10: EF input (07-28)	<input type="radio"/>	<input type="radio"/>	<input type="radio"/>	<input type="radio"/>	<input type="radio"/>	<input type="radio"/>
11: Reserved						
12: Stop output	<input type="radio"/>	<input type="radio"/>	<input type="radio"/>	<input type="radio"/>	<input type="radio"/>	<input type="radio"/>
13: Reserved						
14: Reserved						
15: operation speed command form AUI1	<input type="radio"/>	<input type="radio"/>	<input type="radio"/>	<input type="radio"/>	<input type="radio"/>	<input type="radio"/>
16: operation speed command form ACI	<input type="radio"/>	<input type="radio"/>	<input type="radio"/>	<input type="radio"/>	<input type="radio"/>	<input type="radio"/>
17: operation speed command form AUI2	<input type="radio"/>	<input type="radio"/>	<input type="radio"/>	<input type="radio"/>	<input type="radio"/>	<input type="radio"/>
18: Emergency Stop (07-28)	<input type="radio"/>	<input type="radio"/>	<input type="radio"/>	<input type="radio"/>	<input type="radio"/>	<input type="radio"/>
19-23: Reserved						
24: FWD JOG command	<input type="radio"/>	<input type="radio"/>	<input type="radio"/>	<input type="radio"/>	<input type="radio"/>	<input type="radio"/>
25: REV JOG command	<input type="radio"/>	<input type="radio"/>	<input type="radio"/>	<input type="radio"/>	<input type="radio"/>	<input type="radio"/>
26: Reserved						
27: ASR1/ASR2 selection	<input type="radio"/>	<input type="radio"/>	<input type="radio"/>	<input type="radio"/>	<input type="radio"/>	<input type="radio"/>
28: Emergency stop (EF1) (Motor coasts to stop)	<input type="radio"/>	<input type="radio"/>	<input type="radio"/>	<input type="radio"/>	<input type="radio"/>	<input type="radio"/>
29-30: Reserved						

Settings	Control Mode					
	VF	VFPG	SVC	FOCPG	TQCPG	FOCPM
31: High torque bias (by Pr.07-21)	<input type="radio"/>	<input type="radio"/>	<input type="radio"/>	<input type="radio"/>	<input type="radio"/>	<input type="radio"/>
32: Middle torque bias (by Pr.07-22)	<input type="radio"/>	<input type="radio"/>	<input type="radio"/>	<input type="radio"/>	<input type="radio"/>	<input type="radio"/>
33: Low torque bias (by Pr.07-23)	<input type="radio"/>	<input type="radio"/>	<input type="radio"/>	<input type="radio"/>	<input type="radio"/>	<input type="radio"/>
34-37: Reserved						
38: Disable write EEPROM function	<input type="radio"/>	<input type="radio"/>	<input type="radio"/>	<input type="radio"/>	<input type="radio"/>	<input type="radio"/>
39: Torque command direction					<input type="radio"/>	
40: Enable drive function	<input type="radio"/>	<input type="radio"/>	<input type="radio"/>	<input type="radio"/>	<input type="radio"/>	<input type="radio"/>
41: Detection of magnetic contactor	<input type="radio"/>	<input type="radio"/>	<input type="radio"/>	<input type="radio"/>	<input type="radio"/>	<input type="radio"/>
42: Mechanical brake	<input type="radio"/>	<input type="radio"/>	<input type="radio"/>	<input type="radio"/>	<input type="radio"/>	<input type="radio"/>
43: EPS function	<input type="radio"/>	<input type="radio"/>	<input type="radio"/>	<input type="radio"/>	<input type="radio"/>	<input type="radio"/>

-  This parameter selects the functions for each multi-function terminal.
-  If Pr.02-00 is set to 3-wire operation control. Terminal MI1 is for STOP terminal. Therefore, MI1 is not allowed for any other operation.

Settings	Functions	Descriptions									
0	No Function										
1	Multi-step speed command 1	15 step speeds could be conducted through the digital statuses of the 4 terminals, and 17 in total if the master speed and JOG are included. (Refer to Pr. 04-00-04-14) When using communication to control the multi-step speed, setting 1 to 4 will be invalid.									
2	Multi-step speed command 2										
3	Multi-step speed command 3										
4	Multi-step speed command 4										
5	Reset	After the error of the drive is eliminated, use this terminal to reset the drive.									
6	JOG Command	JOG operation									
7	Acceleration/deceleration Speed Inhibit	When this function is enabled, acceleration and deceleration is stopped and the AC motor drive starts to accel./decel. from the inhibit point.									
8	The 1 st , 2 nd acceleration or deceleration time selection	<p>The acceleration/deceleration time of the drive could be selected from this function or the digital statuses of the terminals; there are 4 acceleration/deceleration speeds in total for selection.</p> <table border="1"> <thead> <tr> <th>Bit</th> <th>Bit</th> <th>Descriptions</th> </tr> </thead> <tbody> <tr> <td>0</td> <td>1</td> <td></td> </tr> <tr> <td>0</td> <td>0</td> <td>First acceleration/deceleration time When output frequency is less than Pr.01-23 (Switch Frequency between 1st/4th</td> </tr> </tbody> </table>	Bit	Bit	Descriptions	0	1		0	0	First acceleration/deceleration time When output frequency is less than Pr.01-23 (Switch Frequency between 1st/4th
Bit	Bit	Descriptions									
0	1										
0	0	First acceleration/deceleration time When output frequency is less than Pr.01-23 (Switch Frequency between 1st/4th									

Settings	Functions	Descriptions												
9	The 3 rd , 4 th acceleration or deceleration time selection	<table border="0"> <tr> <td>0</td> <td>1</td> <td>between 1st/4th Accel./decel), it will output 4th accel./decel. time.</td> </tr> <tr> <td>1</td> <td>0</td> <td>2nd accel./decel. time</td> </tr> <tr> <td>1</td> <td>1</td> <td>3rd accel./decel. time</td> </tr> <tr> <td></td> <td></td> <td>4th accel./decel. time</td> </tr> </table> <p>If the drive receives STOP command, it will decelerate to stop by Pr.01-31.</p>	0	1	between 1st/4th Accel./decel), it will output 4 th accel./decel. time.	1	0	2 nd accel./decel. time	1	1	3 rd accel./decel. time			4 th accel./decel. time
0	1	between 1st/4th Accel./decel), it will output 4 th accel./decel. time.												
1	0	2 nd accel./decel. time												
1	1	3 rd accel./decel. time												
		4 th accel./decel. time												
10	EF Input	External fault input terminal and decelerates by Pr.07-28. (EF fault will be recorded)												
11	Reserved													
12	Stop output	When this function is enabled, the drive output will stop immediately and the motor is free run. When this function is disabled, the drive will accelerate to the frequency setting.												
13-14	Reserved													
15	Operation speed command form AUI1	When the source of operation speed command is set to AUI1, ACI and AUI2 at the same time and two or above terminals are ON, the priority is AUI1>ACI>AUI2. When this function is enabled, the source of the frequency will force to be AUI1.												
16	Operation speed command form ACI	When this function is enabled, the source of the frequency will force to be ACI.												
17	Operation speed command form AUI2	When this function is enabled, the source of the frequency will force to be AUI2.												
18	Emergency Stop	When this function is enabled, the drive will ramp to stop by Pr.07-28 setting.												
19-23	Reserved													
24	FWD JOG command	When this function is enabled, the drive will execute forward Jog command.												
25	REV JOG command	When this function is enabled, the drive will execute reverse Jog command.												
26	Reserved													
27	ASR1/ASR2 selection	ON: speed will be adjusted by ASR 2 setting. OFF: speed will be adjusted by ASR 1 setting.												
28	Emergency stop (EF1) (Motor coasts to stop)	When it is ON, the drive will execute emergency stop. (it will have fault code record)												
29-30	Reserved													
31	High torque bias	When Pr.07-19 is set to 3:												

Settings	Functions	Descriptions
32	Middle torque bias	The high torque bias is according to the Pr.07-21 setting.
33	Low torque bias	The middle torque bias is according to the Pr.07-22 setting.
		The low torque bias is according to the Pr.07-23 setting.
		31 32 33 Torque Bias
		OFF OFF OFF No
		OFF OFF ON 07-23
		OFF ON OFF 07-22
		OFF ON ON 07-23+07-22
		ON OFF OFF 07-21
		ON OFF ON 07-21+07-23
		ON ON OFF 07-21+07-22
ON ON ON 07-21+07-22+07-23		
34-37	Reserved	
38	Disable write EEPROM function	When this function is enabled, you can't write into EEPROM.
39	Torque command direction	When Pr.07-13=2 and analog input is ACI or unipolar AUI, torque command direction is decided by this terminal.
40	Enable drive function	When this function is enabled, the drive function can be executed. This function can be used with multi-function output (setting Pr.02-11~Pr.02-14 to 15) and (Pr.02-31 and Pr.02-32).
41	Detection of magnetic contactor	This terminal is used for the feedback signal of magnetic contactor ON/OFF. When drive receives RUN command, the corresponding output terminal (setting 15) will be enabled after Pr.02-31 time. It will check if this function is enabled within the detection time (Pr.02-36). If NOT, the fault of mechanical brake occurs and fault code "MCF" will be displayed.
42	Mechanical brake	When drive receives RUN command, the corresponding output terminal (setting 12) will be enabled after Pr.02-29 time. It will check if this function is enabled within the detection time (Pr.02-35). If NOT, the fault of mechanical brake occurs and fault code "MBF" will be displayed.
43	EPS function	If power is cut during running, the drive will stop when DC bus voltage is less than low voltage level. After power is cut, drive will run by the frequency depend on EPS when EPS is applied and this function is ON.

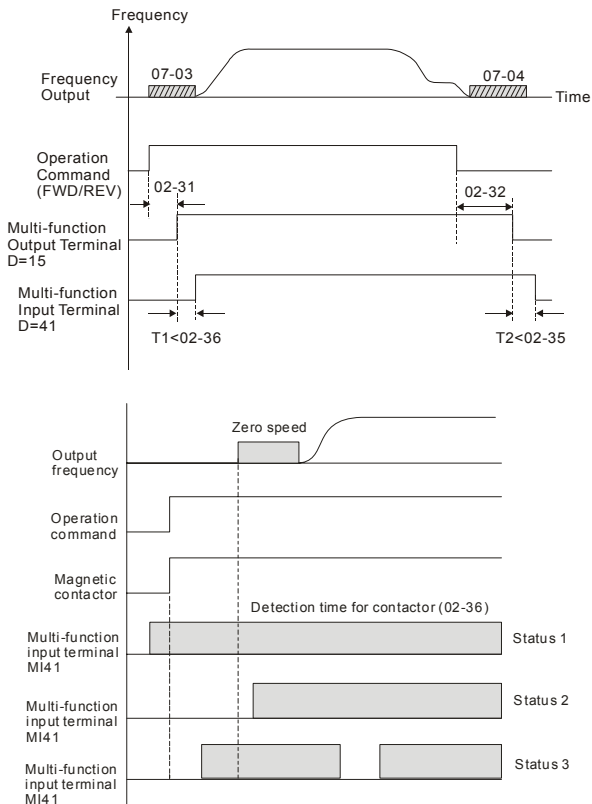

02-09

Digital Input Response Time

Control mode VF VFPG SVC FOC PG TQCPG FOC PM

Factory setting: 0.005

Settings 0.001~ 30.000 sec





This parameter is used for digital input terminal signal delay and confirmation. The delay time is confirmation time to prevent some uncertain interferences that would result in error (except for the counter input) in the input of the digital terminals (FWD, REV and MI1~8). Under this condition, confirmation for this parameter could be improved effectively, but the response time will be somewhat delayed.

02-10 / Digital Input Operation Direction

Control mode VF VFPG SVC FOC PG TQCPG FOC PM

Factory setting: 0

Settings 0 ~ 65535

-  This parameter is used to set the input signal level and it won't be affected by the SINK/SOURCE status.
-  Bit0 is for FWD terminal, bit1 is for REV terminal and bit2 to bit9 is for MI1 to MI8.
-  User can change terminal status by communicating.
- For example, MI1 is set to 1 (multi-step speed command 1), MI2 is set to 2 (multi-step speed command 2). Then the forward + 2nd step speed command=1001(binary)=9 (Decimal). Only need to set Pr.02-10=9 by communication and it can forward with 2nd step speed. It doesn't need to wire any multi-function terminal.

bit9	bit8	bit7	bit6	bit5	bit4	bit3	bit2	bit1	bit0
MI8	MI7	MI6	MI5	MI4	MI3	MI2	MI1	REV	FWD

02-11 Multi-function Output 1 RA, RB, RC (Relay1)

Factory Setting: 11

02-12 Multi-function Output 2 MRA, MRC (Relay2)

Factory Setting: 1

02-13 Multi-function Output 3 (MO1)**02-14** Multi-function Output 4 (MO2)**02-15** Multi-function Output 5 (MO3) (need to use with EMVL-IODA01)**02-16** Multi-function Output 6 (MO4) (need to use with EMVL-IODA01)**02-17** Multi-function Output 7 (MO5) (need to use with EMVL-IODA01)**02-18** Multi-function Output 8 (MO6) (need to use with EMVL-IODA01)**02-19** Multi-function Output 9 (MO7) (need to use with EMVL-IODA01)**02-20** Multi-function Output 10 (MO8) (need to use with EMVL-IODA01)**02-21** Multi-function Output 11 (MO9) (need to use with EMVL-IODA01)**02-22** Multi-function Output 12 (MO10) (need to use with EMVL-IODA01)

Factory Setting: 0

Settings 0-41

Settings	Control Mode					
	VF	VFPG	SVC	FOCPG	TQCPG	FOCPM
0: No function	<input type="radio"/>	<input type="radio"/>	<input type="radio"/>	<input type="radio"/>	<input type="radio"/>	<input type="radio"/>
1: Operation indication	<input type="radio"/>	<input type="radio"/>	<input type="radio"/>	<input type="radio"/>	<input type="radio"/>	<input type="radio"/>
2: Operation speed attained	<input type="radio"/>	<input type="radio"/>	<input type="radio"/>	<input type="radio"/>	<input type="radio"/>	<input type="radio"/>
3: Desired frequency attained 1 (Pr.02-25, 02-26)	<input type="radio"/>	<input type="radio"/>	<input type="radio"/>	<input type="radio"/>	<input type="radio"/>	<input type="radio"/>
4: Desired frequency attained 2 (Pr.02-27, 02-28)	<input type="radio"/>	<input type="radio"/>	<input type="radio"/>	<input type="radio"/>	<input type="radio"/>	<input type="radio"/>
5: Zero speed (frequency command)	<input type="radio"/>	<input type="radio"/>	<input type="radio"/>	<input type="radio"/>	<input type="radio"/>	<input type="radio"/>
6: Zero speed with stop (frequency command)	<input type="radio"/>	<input type="radio"/>	<input type="radio"/>	<input type="radio"/>	<input type="radio"/>	<input type="radio"/>
7: Over torque (OT1) (Pr.06-05-06-07)	<input type="radio"/>	<input type="radio"/>	<input type="radio"/>	<input type="radio"/>	<input type="radio"/>	<input type="radio"/>
8: Over torque (OT2) (Pr.06-08-06-10)	<input type="radio"/>	<input type="radio"/>	<input type="radio"/>	<input type="radio"/>	<input type="radio"/>	<input type="radio"/>
9: Drive ready	<input type="radio"/>	<input type="radio"/>	<input type="radio"/>	<input type="radio"/>	<input type="radio"/>	<input type="radio"/>
10: User-defined Low-voltage Detection (LV)	<input type="radio"/>	<input type="radio"/>	<input type="radio"/>	<input type="radio"/>	<input type="radio"/>	<input type="radio"/>
11: Malfunction indication	<input type="radio"/>	<input type="radio"/>	<input type="radio"/>	<input type="radio"/>	<input type="radio"/>	<input type="radio"/>
12: Mechanical brake release (Pr.02-29, Pr.02-30)	<input type="radio"/>	<input type="radio"/>	<input type="radio"/>	<input type="radio"/>	<input type="radio"/>	<input type="radio"/>
13: Overheat (Pr.06-14)	<input type="radio"/>	<input type="radio"/>	<input type="radio"/>	<input type="radio"/>	<input type="radio"/>	<input type="radio"/>
14: Brake chopper signal	<input type="radio"/>	<input type="radio"/>	<input type="radio"/>	<input type="radio"/>	<input type="radio"/>	<input type="radio"/>
15: Motor-controlled magnetic contactor output	<input type="radio"/>	<input type="radio"/>	<input type="radio"/>	<input type="radio"/>	<input type="radio"/>	<input type="radio"/>
16: Slip error (oSL)	<input type="radio"/>	<input type="radio"/>	<input type="radio"/>	<input type="radio"/>	<input type="radio"/>	<input type="radio"/>
17: Malfunction indication 1	<input type="radio"/>	<input type="radio"/>	<input type="radio"/>	<input type="radio"/>	<input type="radio"/>	<input type="radio"/>
18: Reserved						
19: Brake chopper output error	<input type="radio"/>	<input type="radio"/>	<input type="radio"/>	<input type="radio"/>	<input type="radio"/>	<input type="radio"/>
20: Warning output	<input type="radio"/>	<input type="radio"/>	<input type="radio"/>	<input type="radio"/>	<input type="radio"/>	<input type="radio"/>
21: Over voltage warning	<input type="radio"/>	<input type="radio"/>	<input type="radio"/>	<input type="radio"/>	<input type="radio"/>	<input type="radio"/>
22: Over-current stall prevention warning	<input type="radio"/>	<input type="radio"/>	<input type="radio"/>	<input type="radio"/>	<input type="radio"/>	<input type="radio"/>
23: Over-voltage stall prevention warning	<input type="radio"/>	<input type="radio"/>	<input type="radio"/>	<input type="radio"/>	<input type="radio"/>	<input type="radio"/>
24: Operation mode indication (Pr.00-15≠0)	<input type="radio"/>	<input type="radio"/>	<input type="radio"/>	<input type="radio"/>	<input type="radio"/>	<input type="radio"/>
25: Forward command	<input type="radio"/>	<input type="radio"/>	<input type="radio"/>	<input type="radio"/>	<input type="radio"/>	<input type="radio"/>
26: Reverse command	<input type="radio"/>	<input type="radio"/>	<input type="radio"/>	<input type="radio"/>	<input type="radio"/>	<input type="radio"/>
27: Output when current >= Pr.02-33	<input type="radio"/>	<input type="radio"/>	<input type="radio"/>	<input type="radio"/>	<input type="radio"/>	<input type="radio"/>
28: Output when current < Pr.02-33	<input type="radio"/>	<input type="radio"/>	<input type="radio"/>	<input type="radio"/>	<input type="radio"/>	<input type="radio"/>
29: Output when frequency >= Pr.02-34	<input type="radio"/>	<input type="radio"/>	<input type="radio"/>	<input type="radio"/>	<input type="radio"/>	<input type="radio"/>
30: Output when frequency < Pr.02-34	<input type="radio"/>	<input type="radio"/>	<input type="radio"/>	<input type="radio"/>	<input type="radio"/>	<input type="radio"/>
31: Power generation direction and status verify	<input type="radio"/>	<input type="radio"/>	<input type="radio"/>	<input type="radio"/>	<input type="radio"/>	<input type="radio"/>
32: Power generation direction	<input type="radio"/>	<input type="radio"/>	<input type="radio"/>	<input type="radio"/>	<input type="radio"/>	<input type="radio"/>
33: Zero speed (actual output frequency)	<input type="radio"/>	<input type="radio"/>	<input type="radio"/>	<input type="radio"/>	<input type="radio"/>	<input type="radio"/>
34: Zero speed with Stop (actual output frequency)	<input type="radio"/>	<input type="radio"/>	<input type="radio"/>	<input type="radio"/>	<input type="radio"/>	<input type="radio"/>
35: Fault output option 1 (Pr.06-22)	<input type="radio"/>	<input type="radio"/>	<input type="radio"/>	<input type="radio"/>	<input type="radio"/>	<input type="radio"/>
36: Fault output option 2 (Pr.06-23)	<input type="radio"/>	<input type="radio"/>	<input type="radio"/>	<input type="radio"/>	<input type="radio"/>	<input type="radio"/>
37: Fault output option 3 (Pr.06-24)	<input type="radio"/>	<input type="radio"/>	<input type="radio"/>	<input type="radio"/>	<input type="radio"/>	<input type="radio"/>
38: Fault output option 4 (Pr.06-25)	<input type="radio"/>	<input type="radio"/>	<input type="radio"/>	<input type="radio"/>	<input type="radio"/>	<input type="radio"/>
39: Reserved						
40: Speed attained (including zero speed)	<input type="radio"/>	<input type="radio"/>	<input type="radio"/>	<input type="radio"/>	<input type="radio"/>	<input type="radio"/>
41: Reserved						

Settings	Functions	Descriptions
0	No Function	
1	AC Drive Operational	Active when there is an output from the drive or RUN command is ON.

Settings	Functions	Descriptions
2	Operation speed attained	Active when the AC motor drive reaches the output frequency setting.
3	Desired Frequency Attained 1 (Pr.02-25, 02-26)	Active when the desired frequency (Pr.02-25, 02-26) is attained.
4	Desired Frequency Attained 2 (Pr.02-27, 02-28)	Active when the desired frequency (Pr.02-27, 02-28) is attained.
5	Zero Speed (frequency command)	Active when frequency command =0. (the drive should be at RUN mode)
6	Zero Speed with Stop (frequency command)	Active when frequency command =0 or stop.
7	Over Torque (OT1) (Pr.06-05~06-07)	Active when detecting over-torque. Refer to Pr.06-05 (over-torque detection selection-OT1), Pr.06-06 (over-torque detection level-OT1) and Pr.06-07 (over-torque detection time-OT1).
8	Over Torque (OT2) (Pr.06-08~06-10)	Active when detecting over-torque. Refer to Pr.06-08 (over-torque detection selection-OT2), Pr.06-09 (over-torque detection level-OT2) and Pr.06-10 (over-torque detection time-OT2).
9	Drive Ready	Active when the drive is ON and no abnormality detected.
10	User-defined Low-voltage Detection	Active when the DC Bus voltage is too low. (refer to Pr.06-00 low voltage level)
11	Malfunction Indication	Active when fault occurs (except Lv stop).
12	Mechanical Brake Release (Pr.02-29, Pr.02-30)	When drive runs after Pr.02-29, it will be ON. This function should be used with DC brake and it is recommended to use contact "b"(N.C).
13	Overheat (Pr.06-14)	Active when IGBT or heat sink overheats to prevent OH turn off the drive. (refer to Pr.06-14)
14	Brake Chopper Signal	The output will be activated when the drive needs help braking the load. A smooth deceleration is achieved by using this function. (refer to Pr.07-00)
15	Motor-controlled Magnetic Contactor Output	Active when the setting is set to 15.
16	Slip Error (oSL)	Active when the slip error is detected (by Pr.05-14).
17	Malfunction indication 1	Activate after 10ms when fault occurs (except Lv stop).

Settings	Functions	Descriptions
18	Reserved	
19	Brake Chopper Output Error	Active when the brake chopper error is detected.
20	Warning Output	Active when the warning is detected.
21	Over-voltage Warning	Active when the over-voltage is detected.
22	Over-current Stall Prevention Warning	Active when the over-current stall prevention is detected.
23	Over-voltage Stall prevention Warning	Active when the over-voltage stall prevention is detected.
24	Operation Mode Indication	Active when the operation command is controlled by external terminal. (Pr.00-15=1) and PU LED on keypad KPVL-CC01 is OFF.
25	Forward Command	Active when the operation direction is forward.
26	Reverse Command	Active when the operation direction is reverse.
27	Output when Current \geq Pr.02-33	Active when current is \geq Pr.02-33.
28	Output when Current $<$ Pr.02-33	Active when current is $<$ Pr.02-33.
29	Output when frequency \geq Pr.02-34	Active when frequency is \geq Pr.02-34.
30	Output when Frequency $<$ Pr.02-34	Active when frequency is $<$ Pr.02-34.
31	Power Generation Direction and Status Verify	Activate when power generation direction is verified.
32	Power Generation Direction	Activate when power generation direction is forward run.
33	Zero Speed (actual output frequency)	Active when the actual output frequency is 0. (the drive should be at RUN mode)
34	Zero Speed with Stop (actual output frequency)	Active when the actual output frequency is 0 or Stop. (the drive should be at RUN mode)
35	Fault output option 1	Active when Pr.06-22 is ON.
36	Fault output option 2	Active when Pr.06-23 is ON.

Settings	Functions	Descriptions
37	Fault output option 3	Active when Pr.06-24 is ON.
38	Fault output option 4	Active when Pr.06-25 is ON.
39	Reserved	
40	Speed Attained (including zero speed)	Active when the output frequency reaches frequency setting.
41	Reserved	

02-23  Multi-output Direction

Control mode	VF	VFPG	SVC	FOCPG	TQCPG	FOCPM	Factory setting:
Settings	0 ~ 65535						0

 This parameter is bit setting. If the bit is 1, the multi-function output terminal will be act with opposite direction. For example, if Pr.02-11 is set to 1 and forward bit is 0, Relay 1 will be ON when the drive is running and OFF when the drive is stop.

 The multi-function output terminals MO3~MO10 need to use with EMVL-IODA01.

Bit 11	Bit 10	Bit 9	Bit 8	Bit 7	Bit 6	Bit 5	Bit 4	Bit 3	Bit 2	Bit 1	Bit 0
MO10	MO9	MO8	MO7	MO6	MO5	MO4	MO3	MO2	MO1	MRA	RA

02-24  Serial Start Signal Selection

Control mode	VF	VFPG	SVC	FOCPG	FOCPM	Factory setting:
Settings	0 by FWD/REV					0
	1 by Enable					

 This parameter is used to select serial start method of electromagnetic valve.

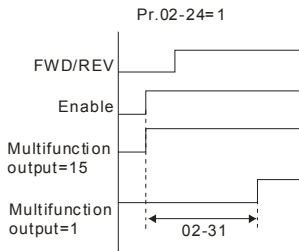
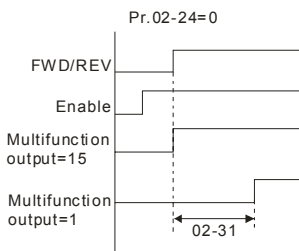
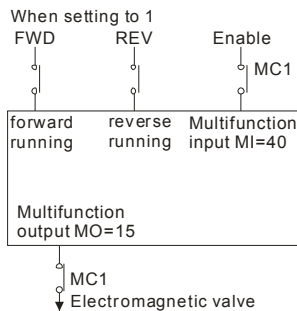
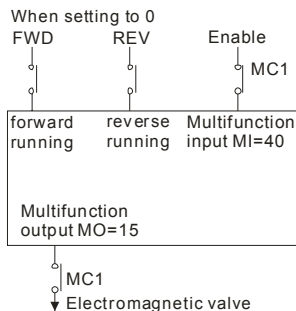

02-25 ⚡ Desired Frequency Attained 1

Control mode	VF	VFPG	SVC	FOCPG	FOCPM	Factory setting: 60.00/50.00
--------------	----	------	-----	-------	-------	------------------------------

02-26 ⚡ The Width of the Desired Frequency Attained 1

Control mode	VF	VFPG	SVC	FOCPG	FOCPM	Factory setting: 2.00
--------------	----	------	-----	-------	-------	-----------------------

02-27 ⚡ Desired Frequency Attained 2

Control mode	VF	VFPG	SVC	FOCPG	FOCPM	Factory setting: 60.00/50.00
--------------	----	------	-----	-------	-------	------------------------------

02-28 ⚡ The Width of the Desired Frequency Attained 2

Control mode	VF	VFPG	SVC	FOCPG	FOCPM	Factory setting: 2.00
--------------	----	------	-----	-------	-------	-----------------------

Settings 0.00 ~ 400.00Hz

Once output frequency reaches desired frequency and the corresponding multi-function output terminal is set to 3 or 4 (Pr.02-11~Pr.02-22), this multi-function output terminal will be ON.

02-29 Brake Release Delay Time when Elevator Starts

Control mode	VF	VFPG	SVC	FOCPG	TQCPG	FOCPM	Factory setting: 0.250
--------------	----	------	-----	-------	-------	-------	------------------------

02-30 Brake Engage Delay Time when Elevator Stops

Control mode	VF	VFP	SVC	FOCPG	TQCPG	FOCPM	Factory setting: 0.250
Settings	0.000~65.000 Sec						

When the AC motor drive runs after Pr.02-29 delay time, the corresponding multi-function output terminal (12: mechanical brake release) will be ON. This function should be used with DC brake.

When the AC motor drive stops after Pr.02-30 delay time, the corresponding multi-function output terminal (12: mechanical brake release) will be OFF.

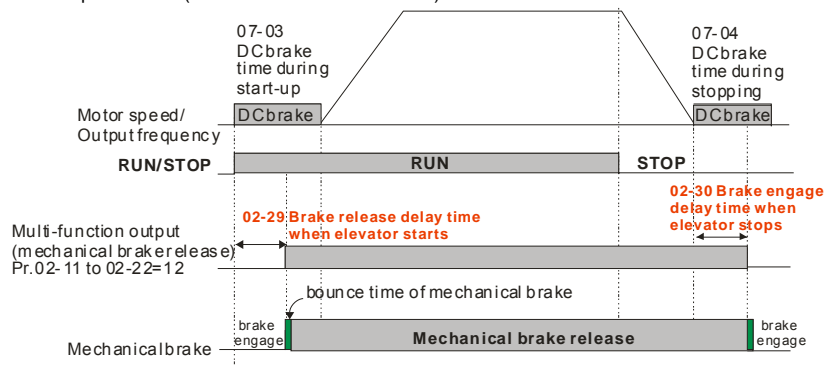
**02-31** Turn On Delay of Magnetic Contact between Drive and Motor**02-32** Turn Off Delay of Magnetic Contact between Drive and Motor

Control mode	VF	VFP	SVC	FOCPG	TQCPG	FOCPM	Factory setting: 0.200
Settings	0.000~65.000 Sec						

After running, it is used with setting 40 of multifunction input terminal and settings 15 of multifunction output terminals. When multifunction output terminals is ON, the drive starts output after Pr.02-31 delay time. When drive stops output, multifunction output terminals will release after Pr.02-32 delay time.

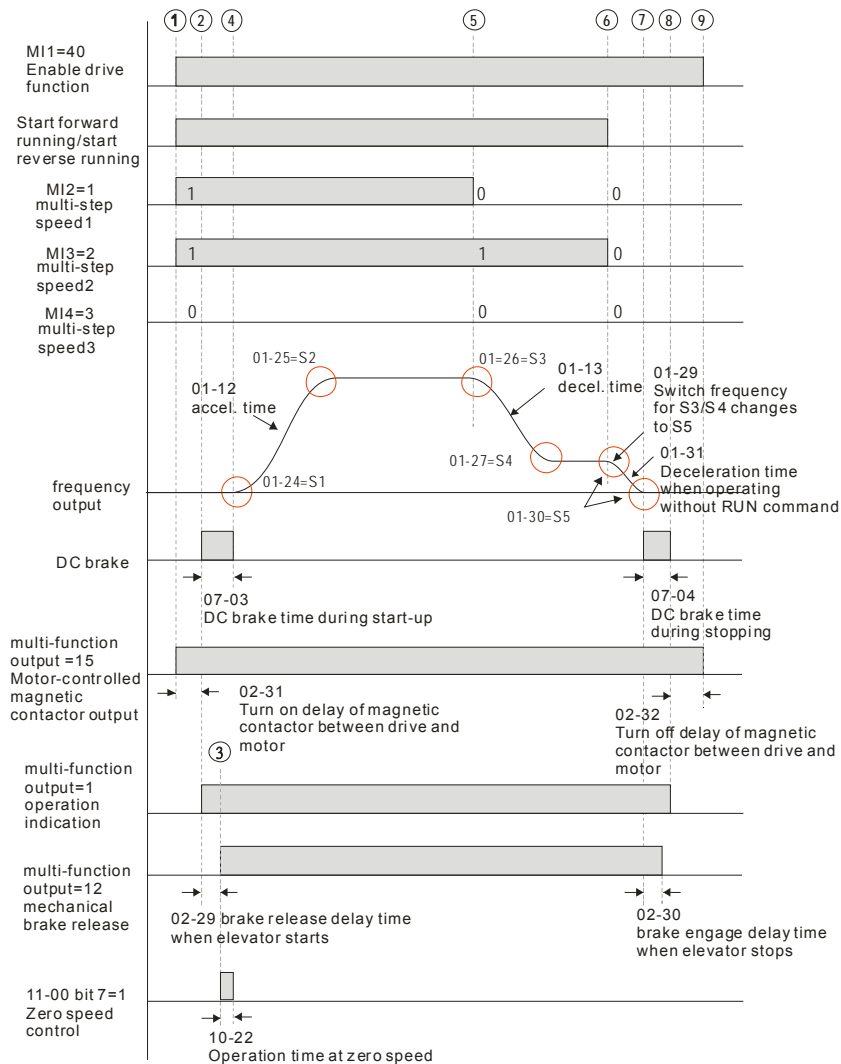



- ① elevator starts running
- ② electromagnetic valve is ON
- ③ brake release
- ④ the end of DC brake time at start-up
- ⑤ start deceleration
- ⑥ the end of creep
- ⑦ start DC brake time during stopping
- ⑧ the end of DC brake time during stopping
- ⑨ motor release

02-33 ✓ Output Current Level Setting for External Terminals

Control mode	VF	VFP	SVC	FOCPG	TQCPG	FOCPM	Factory setting: 0
--------------	----	-----	-----	-------	-------	-------	--------------------

Settings	0~100%
----------	--------

 When output current is \geq Pr.02-33, it will activate multi-function output terminal (Pr.02-11 to Pr.02-22 is set to 27).

 When output current is $<$ Pr.02-33, it will activate multi-function output terminal (Pr.02-11 to Pr.02-22 is set to 28).

02-34 ✓ Output Boundary for External Terminals

Control mode	VF	VFP	SVC	FOCPG	TQCPG	FOCPM	Factory setting: 0.00
--------------	----	-----	-----	-------	-------	-------	-----------------------

Settings	0.00~±400.00Hz
----------	----------------

 When output frequency is \geq 02-34, it will activate the multi-function terminal (Pr.02-11 to Pr.02-22 is set to 29).

 When output frequency is $<$ 02-34, it will activate the multi-function terminal (Pr.02-11 to Pr.02-22 is set to 30).

02-35 ✓ Detection Time of Mechanical Brake

Control mode	VF	VFP	SVC	FOCPG	TQCPG	FOCPM	Factory setting: 0.00
--------------	----	-----	-----	-------	-------	-------	-----------------------

Settings	0.00 ~ 10.00 sec
----------	------------------

 When mechanical brake function (setting 42 of Pr.02-01~02-08) is not enabled within this setting time, it will display fault code 64 (MBF) mechanical brake error.

02-36 ✓ Detection Time of Magnetic Contactor

Control mode	VF	VFP	SVC	FOCPG	TQCPG	FOCPM	Factory setting: 0.00
--------------	----	-----	-----	-------	-------	-------	-----------------------

Settings	0.00 ~ 10.00 sec
----------	------------------

 When mechanical brake function (setting 41 of Pr.02-01~02-08) is not enabled within this setting time, it will display fault code 66 (MCF) mechanical brake error.

02-37 Check Torque Output Function

Control mode	VF	VFPG	SVC	FOCPG	TQCPG	FOCPM	Factory setting:
		0	Enable				0
		1	Disable				

- When the drive receives the operation signal, the drive will check if there is torque output. When this function is enabled, it will release mechanical brake after confirming that there is torque output.

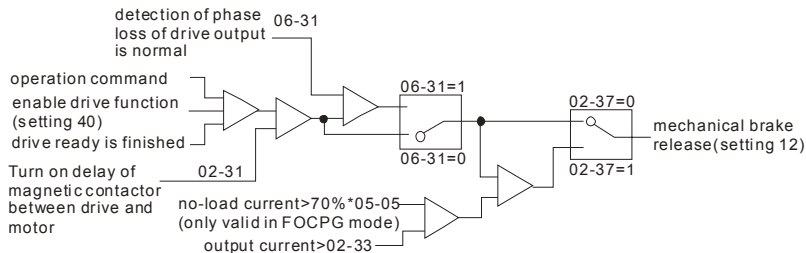

4.2.4 Group 3 Analog Input/Output Parameters

03-00  Analog Input 1 (AUI1)

Factory Setting: 1

03-01  Analog Input 2 (ACI)



Factory Setting: 0

03-02  Analog Input 3 (AUI2)

Factory Setting: 0



Settings	Control Mode					
	VF	VFPG	SVC	FOCPG	TQCPG	FOCPM
0: No function	<input type="radio"/>	<input type="radio"/>	<input type="radio"/>	<input type="radio"/>	<input type="radio"/>	<input type="radio"/>
1: Frequency command (torque limit under TQR control mode)	<input type="radio"/>	<input type="radio"/>	<input type="radio"/>	<input type="radio"/>	<input type="radio"/>	<input type="radio"/>
2: Torque command (torque limit under speed mode)					<input type="radio"/>	
3: Preload input	<input type="radio"/>	<input type="radio"/>	<input type="radio"/>	<input type="radio"/>	<input type="radio"/>	<input type="radio"/>
4-5: Reserved						
6: P.T.C. thermistor input value	<input type="radio"/>	<input type="radio"/>	<input type="radio"/>	<input type="radio"/>	<input type="radio"/>	<input type="radio"/>
7: Positive torque limit				<input type="radio"/>		<input type="radio"/>
8: Negative torque limit				<input type="radio"/>		<input type="radio"/>
9: Regenerative torque limit				<input type="radio"/>		<input type="radio"/>
10: Positive/negative torque limit				<input type="radio"/>		<input type="radio"/>
11: Preload Input						<input type="radio"/>

-  When it is frequency command or TQR speed limit, the corresponding value for 0~±10V/4~20mA is 0 – max. output frequency(Pr.01-00)
-  When it is torque command or torque limit, the corresponding value for 0~±10V/4~20mA is 0 – max. output torque (Pr.07-14).
-  When it is torque compensation, the corresponding value for 0~±10V/4~20mA is 0 – rated torque.

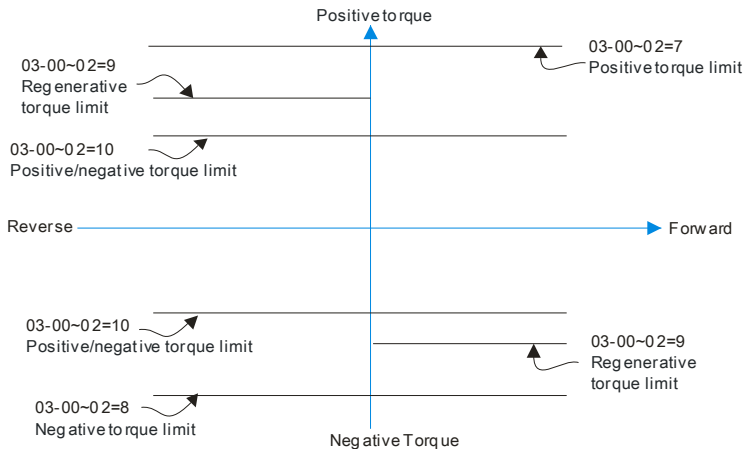

- 07-19: Source of torque offset
- 03-00~02: Analog input selections (AU11/ACI/AU12)
- 03-03~05: Analog input bias (AU11/ACI/AU12)
- 03-06~08: AU11/ACI/AU12 bias mode

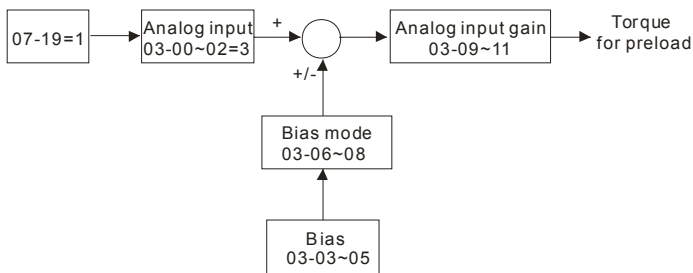

03-03	↗ Analog Input Bias 1 (AU11)						
Control mode	VF	VFG	SVC	FOCPG	TQCPG	FOCPM	Factory setting: 0.0
Settings	-100.0~100.0%						

It is used to set the corresponding AU11 voltage of the external analog input 0.

03-04	↗ Analog Input Bias 1 (ACI)						
Control mode	VF	VFG	SVC	FOCPG	TQCPG	FOCPM	Factory setting: 0.0
Settings	-100.0~100.0%						

 It is used to set the corresponding AC1 voltage of the external analog input 0.

03-05 Analog Input Bias 1 (AUI2)

Control mode	VF	VFPG	SVC	FOCPG	TQCPG	FOCPM	Factory setting: 0.0
Settings	-100.0~100.0%						

 It is used to set the corresponding AUI2 voltage of the external analog input 0.

 The relation between external input voltage/current and setting frequency is equal to -10~+10V (4-20mA) corresponds to 0-60Hz.

03-06 Positive/negative Bias Mode (AUI1)

Control mode	VF	VFPG	SVC	FOCPG	TQCPG	FOCPM	Factory setting: 0
Settings							

03-07 Positive/negative Bias Mode (AC1) (can be set to 0 or 1 only)

Control mode	VF	VFPG	SVC	FOCPG	TQCPG	FOCPM	Factory setting: 0
Settings							

03-08 Positive/negative Bias Mode (AUI2)

Control mode	VF	VFPG	SVC	FOCPG	TQCPG	FOCPM	Factory setting: 0
Settings	0	Zero bias					
	1	Serve bias as the center, lower than bias=bias					
	2	Serve bias as the center, greater than bias=bias					
	3	The absolute value of the bias voltage while serving as the center (unipolar)					
	4	Serve bias as the center (unipolar)					

 In a noisy environment, it is advantageous to use negative bias to provide a noise margin. It is recommended NOT to use less than 1V to set the operating frequency.

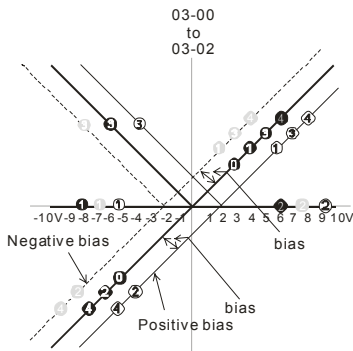

03-09~03-11 gain is positive

0 Zero bias

1 Serve bias as the center, lower than bias=bias

2 Serve bias as the center, greater than bias=bias

3 The absolute value of the bias voltage

while serving as the center (unipolar)

4 Serve bias as the center(unipolar)

03-09	✍ Analog Input Gain 1 (AUI1)						
Control mode	VF	VFPG	SVC	FOCPG	TQCPG	FOCPM	Factory setting: 100.0
03-10	✍ Analog Input Gain 1 (ACI)						
Control mode	VF	VFPG	SVC	FOCPG	TQCPG	FOCPM	Factory setting: 100.0
03-11	✍ Analog Input Gain 1 (AUI2)						
Control mode	VF	VFPG	SVC	FOCPG	TQCPG	FOCPM	Factory setting: 100.0
Settings	0.0~500.0%						

Parameters 03-03 to 03-11 are used when the source of frequency command is the analog voltage/current signal.

03-12	✍ Analog Input Delay Time (AUI1)						
Control mode	VF	VFPG	SVC	FOCPG	TQCPG	FOCPM	Factory setting: 0.01
03-13	✍ Analog Input Delay Time (ACI)						
Control mode	VF	VFPG	SVC	FOCPG	TQCPG	FOCPM	Factory setting: 0.01
03-14	✍ Analog Input Delay Time (AUI2)						
Control mode	VF	VFPG	SVC	FOCPG	TQCPG	FOCPM	Factory setting: 0.01
Settings	0.00 to 2.00 sec						



Interferences commonly exist with analog signals, such as those entering AUI, ACI and AUI2. These interferences constantly affect the stability of analog control and using the Input Noise Filter will create a more stable system.

-  If Pr. 03-14 is large, the control will be stable, yet the response to the input will be slow. If Pr. 03-14 is small, the control may be unstable, yet the response to the input will fast.

03-15  Loss of the ACI Signal

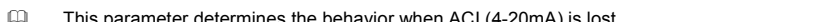
Control mode	VF	VFP	SVC	FOCPG	TQCPG	FOCPM	Factory setting: 0
Settings		0	Disable				
		1	Continue operation at the last frequency				
		2	Decelerate to stop				
		3	Stop immediately and display E.F.				

-  This parameter determines the behavior when ACI (4-20mA) is lost.

03-16 Reserved**03-17**  Analog Output Selection 1**03-20**  Analog Output Selection 2

Factory Setting: 0

Settings	0-20
----------	------



Settings	Control Mode					
	VF	VFP	SVC	FOCPG	TQCPG	FOCPM
0: Output frequency (Hz)	<input type="radio"/>	<input type="radio"/>	<input type="radio"/>	<input type="radio"/>	<input type="radio"/>	<input type="radio"/>
1: Frequency command (Hz)	<input type="radio"/>	<input type="radio"/>	<input type="radio"/>	<input type="radio"/>	<input type="radio"/>	<input type="radio"/>
2: Motor speed (RPM)	<input type="radio"/>	<input type="radio"/>	<input type="radio"/>	<input type="radio"/>	<input type="radio"/>	<input type="radio"/>
3: Output current (rms)	<input type="radio"/>	<input type="radio"/>	<input type="radio"/>	<input type="radio"/>	<input type="radio"/>	<input type="radio"/>
4: Output voltage	<input type="radio"/>	<input type="radio"/>	<input type="radio"/>	<input type="radio"/>	<input type="radio"/>	<input type="radio"/>
5: DC Bus Voltage	<input type="radio"/>	<input type="radio"/>	<input type="radio"/>	<input type="radio"/>	<input type="radio"/>	<input type="radio"/>
6: Power factor	<input type="radio"/>	<input type="radio"/>	<input type="radio"/>	<input type="radio"/>	<input type="radio"/>	<input type="radio"/>
7: Power	<input type="radio"/>	<input type="radio"/>	<input type="radio"/>	<input type="radio"/>	<input type="radio"/>	<input type="radio"/>
8: Output torque	<input type="radio"/>	<input type="radio"/>	<input type="radio"/>	<input type="radio"/>	<input type="radio"/>	<input type="radio"/>
9: AUI1	<input type="radio"/>	<input type="radio"/>	<input type="radio"/>	<input type="radio"/>	<input type="radio"/>	<input type="radio"/>
10: ACI	<input type="radio"/>	<input type="radio"/>	<input type="radio"/>	<input type="radio"/>	<input type="radio"/>	<input type="radio"/>
11: AUI2	<input type="radio"/>	<input type="radio"/>	<input type="radio"/>	<input type="radio"/>	<input type="radio"/>	<input type="radio"/>
12: q-axis current	<input type="radio"/>	<input type="radio"/>	<input type="radio"/>	<input type="radio"/>	<input type="radio"/>	<input type="radio"/>
13: q-axis feedback value	<input type="radio"/>	<input type="radio"/>	<input type="radio"/>	<input type="radio"/>	<input type="radio"/>	<input type="radio"/>
14: d-axis current	<input type="radio"/>	<input type="radio"/>	<input type="radio"/>	<input type="radio"/>	<input type="radio"/>	<input type="radio"/>
15: d-axis feedback value	<input type="radio"/>	<input type="radio"/>	<input type="radio"/>	<input type="radio"/>	<input type="radio"/>	<input type="radio"/>
16: q-axis voltage	<input type="radio"/>	<input type="radio"/>	<input type="radio"/>	<input type="radio"/>	<input type="radio"/>	<input type="radio"/>
17: d-axis voltage	<input type="radio"/>	<input type="radio"/>	<input type="radio"/>	<input type="radio"/>	<input type="radio"/>	<input type="radio"/>
18: Torque command	<input type="radio"/>	<input type="radio"/>	<input type="radio"/>	<input type="radio"/>	<input type="radio"/>	<input type="radio"/>
19-20: Reserved						

03-18 Analog Output Gain 1

03-21 Analog Output Gain 2

Control mode	VF	VFGP	SVC	FOCPG	TQCPG	FOCPM	Factory setting: 100.0
Settings			0				to 200.0%

 This parameter is set the corresponding voltage of the analog output 0.

03-19 Analog Output Value in REV Direction 1

03-22 Analog Output Value in REV Direction 2

Control mode	VF	VFGP	SVC	FOCPG	TQCPG	FOCPM	Factory setting: 0
Settings			0				Absolute value in REV direction
			1				Output 0V in REV direction
			2				Enable output voltage in REV direction

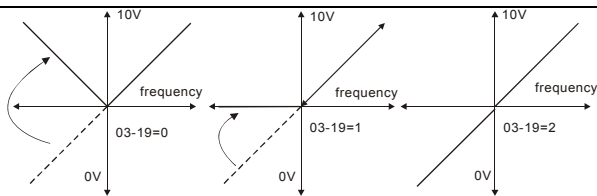

Selection for the analog output direction

03-23 Analog Input Type (AUI1)

03-24 Analog Input Type (AUI2)

Control mode	VF	VFGP	SVC	FOCPG	TQCPG	FOCPM	Factory setting: 0
Settings			0				Bipolar ($\pm 10V$)
			1				Unipolar (0-10V)

 When setting to 0 and Pr.03-00=1 or 2, AUI can decide the operation direction.

 When setting to 1 and Pr.03-00=1, the operation direction can be set by FWD/REV terminal.

 When setting to 1 and Pr.03-00=2, the operation direction can be set by setting 39 of Pr.02-01 to Pr.02-08.

4.2.5 Group 4 Multi-Step Speed Parameters

04-00	↗ Zero Step Speed Frequency	
04-01	↗ 1st Step Speed Frequency	
04-02	↗ 2nd Step Speed Frequency	
04-03	↗ 3rd Step Speed Frequency	
04-04	↗ 4th Step Speed Frequency	
04-05	↗ 5th Step Speed Frequency	
04-06	↗ 6th Step Speed Frequency	
04-07	↗ 7th Step Speed Frequency	
04-08	↗ 8th Step Speed Frequency	
04-09	↗ 9th Step Speed Frequency	
04-10	↗ 10th Step Speed Frequency	
04-11	↗ 11th Step Speed Frequency	
04-12	↗ 12th Step Speed Frequency	
04-13	↗ 13th Step Speed Frequency	
04-14	↗ 14th Step Speed Frequency	
04-15	↗ 15th Step Speed Frequency	
Control mode	VF VFPG SVC FOCPG FOCPM	Factory setting: 0.00
	Settings	0.00 to 400.00 Hz

-  The Multi-Function Input Terminals (refer to Pr.02-01 to 02-08) are used to select one of the AC motor drive Multi-step speeds. The speeds (frequencies) are determined by Pr.04-00 to 04-15 as shown above.

4.2.6 Group 5 IM Parameters

05-00 Motor Auto Tuning

Control mode	VF	Factory setting: 0	
Settings	0	No function	
	1	Rolling test (Rs, Rr, Lm, Lx, no-load current)	
	2	Static Test	

 Starting auto tuning by pressing RUN key and it will write the measure value into Pr.05-05 to Pr.05-09 (Rs, Rr, Lm, Lx, no-load current).

 The steps to AUTO-Tuning are: (when setting to 1)

1. Make sure that all the parameters are set to factory settings and the motor wiring is correct.
2. Make sure the motor has no-load before executing auto-tuning and the shaft is not connected to any belt or gear motor. It is recommended to set to 2 if the motor can't separate from the load.
3. Fill in Pr.01-02, Pr.01-01, Pr.05-01, Pr.05-02, Pr.05-03 and Pr.05-04 with correct values. Refer to motor capacity to set accel./decel. time.
4. When Pr.05-00 is set to 1, the AC motor drive will execute auto-tuning immediately after receiving a "RUN" command. (NOTE: the motor will run!)
5. After executing, please check if all values are filled in Pr.05-05 to Pr.05-09.
6. Equivalent circuit

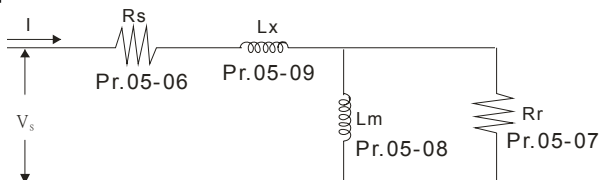

Equivalent circuit for VFD-VL series

 If Pr.05-00 is set to 2, it needs to input Pr.05-05.

 **NOTE**

1. In torque/vector control mode, it is not recommended to have motors run in parallel.
2. It is not recommended to use torque/vector control mode if motor rated power exceeds the rated power of the AC motor drive.
3. The no-load current is usually 20~50% X rated current.

- The rated speed can't be larger or equal to $120f/p$. (f: output frequency Pr.01-01, p: Number of Motor Poles Pr.05-04)
- After the tuning, user needs to activate the drive again to make it operate if the source command of Auto-tuning comes from external terminal,

05-01 Full-load Current of Motor

Control mode	VF	VFPG	SVC	FOCPG	TQCPG	Factory setting: ###
Settings	(40 to 120%)*Pr.00-01 Amps					

 This value should be set according to the rated frequency of the motor as indicated on the motor nameplate. The factory setting is 90% X rated current.

Example: if the rated current for 7.5hp (5.5kW) models is 25A and the factory setting is 22.5A.

In this way, the current range will be from 10A (25*40%) to 30A (25*120%).

05-02 Rated Power of Motor

Control mode	SVC	FOCPG	TQCPG	Factory setting: ###
Settings	0.00 to 655.35 kW		Factory Setting: ###	

 It is used to set rated power of the motor. The factory setting is the power of the drive.

05-03 Rated Speed of Motor (rpm)

Control mode	VFPG	SVC	FOCPG	TQCPG	Factory setting: 1710
Settings	0 to 65535 rpm				

 It is used to set the rated speed of the motor and need to set according to the value indicated on the motor nameplate.

05-04 Number of Motor Poles



Control mode	VF	VFPG	SVC	FOCPG	TQCPG	Factory setting: 4
Settings	2 to 48					

 It is used to set the number of motor poles (must be an even number).

05-05 No-load Current of Motor

Control mode	VFPG	SVC	FOCPG	TQCPG	Factory setting: ###
Settings	0 to 100%				

 The factory setting is 40% X rated current.

05-06	Rs of Motor			
Control mode	SVC	FOCPG	TQCPG	Factory setting: 0.000
05-07	Rr of Motor			
Control mode	SVC	FOCPG	TQCPG	Factory setting: 0.000
	Settings	0.000~65.535Ω		
05-08	Lm of Motor			
Control mode	SVC	FOCPG	TQCPG	Factory setting: 0.0
05-09	Lx of Motor			
Control mode	SVC	FOCPG	TQCPG	Factory setting: 0.0
	Settings	0.0~6553.5mH		
05-10	⚡ Torque Compensation Time Constant			
Control mode	SVC			Factory setting: 0.020
	Settings	0.001 to 10.000 sec		
05-11	⚡ Slip Compensation Time Constant			
Control mode	SVC			Factory setting: 0.100
	Settings	0.001 to 10.000 sec		
	Setting Pr.05-10 and Pr.05-11 change the response time for the compensation.			
	When Pr.05-10 and Pr.05-11 are set to 10 seconds, its response time for the compensation will be the longest. But if the settings are too short, unstable system may occur.			
05-12	⚡ Torque Compensation Gain			
Control mode	VF	VFPG	Factory setting: 0	
	Settings	0 to10		
	This parameter may be set so that the AC motor drive will increase its voltage output to obtain a higher torque.			
05-13	⚡ Slip Compensation Gain			
Control mode	SVC	VFPG	SVC	Factory setting: 0.00
	Settings	0.00 to10.00		

 When the asynchronous motor is driven by the drive, the load and slip will be increased. This parameter can be used to correct frequency and lower the slip to make the motor can run near the synchronous speed under rated current. When the output current is larger than the motor no-load current, the drive will compensate the frequency by Pr.05-13 setting. If the actual speed is slower than expectation, please increase the setting and vice versa.

 It is only valid in SVC mode.

05-14	✓ Slip Deviation Level				
Control mode	VFPG	SVC	FOCPG	Factory setting: 0	
	Settings	0 to 1000% (0: disable)			
05-15	✓ Detection time of Slip Deviation				
Control mode	VFPG	SVC	FOCPG	Factory setting: 1.0	
	Settings	0.0 to 10.0 sec			
05-16	✓ Over Slip Treatment				
Control mode	VFPG	SVC	FOCPG	Factory setting: 0	
	Settings	0	Warn and keep operation		
		1	Warn and ramp to stop		
		2	Warn and coast to stop		

 Pr.05-14 to Pr.05-16 are used to set allowable slip level/time and over slip treatment when the drive is running.

05-17	✓ Hunting Gain				
Control mode	VF	VFPG	SVC	Factory setting: 2000	
	Settings	0 to 10000 (0: disable)			

 The motor will have current wave motion in some specific area. It can improve this situation by setting this parameter. (When it is high frequency or run with PG, Pr.05-17 can be set to 0. when the current wave motion happens in the low frequency, please increase Pr.05-17.)

05-18	Accumulative Motor Operation Time (Min.)						
Control mode	VF	VFPG	SVC	FOCPG	TQCPG	FOCPM	Factory setting: 00
	Settings	00 to 1439 min					

05-19	Accumulative Motor Operation Time (Day)						
Control mode	VF	VFPG	SVC	FOCPG	TQCPG	FOCPM	Factory setting: 00
	Settings	00 to 65535 day					

 Pr. 05-18 and Pr.05-19 are used to record the motor operation time. They can be cleared by setting to 00 and time which is less than 60 seconds will not be recorded.

05-20	✎ Core Loss Compensation						
Control mode	SVC						Factory setting: 10
	Settings	0 to 250%					

05-21	Accumulative Drive Power-on Time (Min.)						
Control mode	VF	VFPG	SVC	FOCPG	TQCPG	FOCPM	Factory setting: 00
	Settings	00 to 1439 min					

05-22	Accumulative Drive Power-on Time (day)						
Control mode	VF	VFPG	SVC	FOCPG	TQCPG	FOCPM	Factory setting: 00
	Settings	00 to 65535 day					

4.2.7 Group 6 Protection Parameters

06-00 Low Voltage Level

Control mode	VF	VFPG	SVC	FOCPG	TQCPG	FOCPM	Factory Setting: 180.0/360.0
Settings	230V series	160.0~220.0Vdc					
	460V series	320.0~440.0Vdc					

 It is used to set the Lv level.

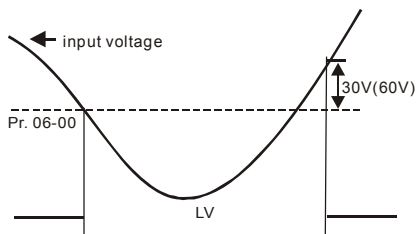

06-01 Phase-loss Protection

Control mode	VF	VFPG	SVC	FOCPG	TQCPG	FOCPM	Factory setting: 2
Settings		0	Warn and keep operation				
		1	Warn and ramp to stop				
		2	Warn and coast to stop				

 It is used to set the phase-loss treatment. The phase-loss will effect driver's control characteristic and life.

06-02 Over-Current Stall Prevention during Acceleration

Control mode	VF	VFPG	SVC	Factory setting: 00
Settings		00~250% (00: disable)		

 During acceleration, the AC drive output current may increase abruptly and exceed the value specified by Pr.06-02 due to rapid acceleration or excessive load on the motor. When this function is enabled, the AC drive will stop accelerating and keep the output frequency constant until the current drops below the maximum value.

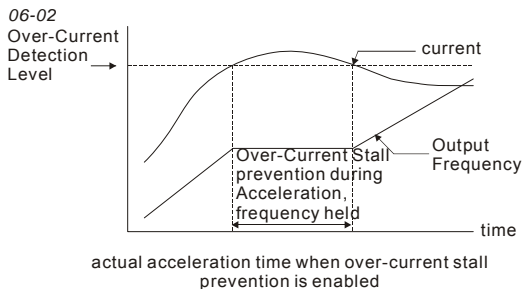

06-03 Over-current Stall Prevention during Operation

Control mode	VF	VFG	SVC	Factory setting: 00
Settings		00 to 250% (00: disable)		

If the output current exceeds the setting specified in Pr.06-03 when the drive is operating, the drive will decrease its output frequency by Pr.06-04 setting to prevent the motor stall. If the output current is lower than the setting specified in Pr.06-03, the drive will accelerate (by Pr.06-04) again to catch up with the set frequency command value.

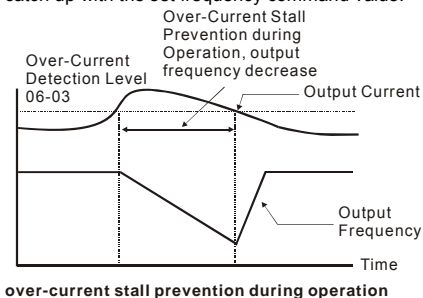



06-04 Accel./Decel. Time Selection of Stall Prevention at constant speed

Control mode	VF	VFG	SVC	Factory setting: 0
Settings		0	by current accel/decel time	
		1	by the 1st accel/decel time	
		2	by the 2nd accel/decel time	
		3	by the 3rd accel/decel time	
		4	by the 4th accel/decel time	
		5	by auto accel/decel time	

 It is used to set the accel./decel. time selection when stall prevention occurs at constant speed.

06-05  Over-torque Detection Selection (OT1)							
Control mode	VF	VFPG	SVC	FOCPG	TQCPG	FOCPM	Factory setting: 0
Settings		0	Over-Torque detection disabled.				
		1	Over-torque detection during constant speed operation, continue to operate after detection				
		2	Over-torque detection during constant speed operation, stop operation after detection				
		3	Over-torque detection during operation, continue to operate after detection				
		4	Over-torque detection during operation, stop operation after detection				

06-06  Over-torque Detection Level (OT1)							
Control mode	VF	VFPG	SVC	FOCPG	TQCPG	FOCPM	Factory setting: 150
Settings		10 to 250%					

06-07  Over-torque Detection Time (OT1)							
Control mode	VF	VFPG	SVC	FOCPG	TQCPG	FOCPM	Factory setting: 0.1
Settings		0.0 to 60.0 sec					

06-08  Over-torque Detection Selection (OT2)							
Control mode	VF	VFPG	SVC	FOCPG	TQCPG	FOCPM	Factory setting: 0
Settings		0	Over-Torque detection disabled.				
		1	Over-torque detection during constant speed operation, continue to operate after detection				
		2	Over-torque detection during constant speed operation, stop operation after detection				
		3	Over-torque detection during operation, continue to operate after detection				
		4	Over-torque detection during operation, stop operation after detection				

06-09  Over-torque Detection Level (OT2)							
Control mode	VF	VFPG	SVC	FOCPG	TQCPG	FOCPM	Factory setting: 150
Settings		10 to 250%					

06-10 **Over-torque Detection Time (OT2)**

Control mode	VF	VFPG	SVC	FOCPG	TQCPG	FOCPM	Factory setting: 0.1
Settings	0.0 to 60.0 sec						

- Pr.06-05 and Pr.06-08 determine the operation mode of the drive after the over-torque is detected via the following method: if the output current exceeds the over-torque detection level (Pr.06-06) and also exceeds the Pr.06-07 Over-Torque Detection Time, the fault code "OT1/OT2" is displayed. If a Multi-Functional Output Terminal is to over-torque detection, the output is on. Please refer to Pr.02-11~02-22 for details.

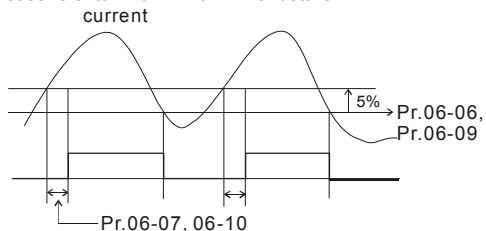
**06-11** **Current Limit**

Control mode	FOCPG	TQCPG	FOCPM	Factory setting: 200
Settings	0 to 250%			

- It is used to set the current limit.

06-12 **Electronic Thermal Relay Selection**

Control mode	VF	VFPG	SVC	FOCPG	TQCPG	FOCPM	Factory setting: 2
Settings	0	Inverter motor					
	1	Standard motor					
	2	Disabled					

- It is used to prevent self-cooled motor overheats under low speed. User can use electrical thermal relay to limit driver's output power.

06-13 **Electronic Thermal Characteristic**

Control mode	VF	VFPG	SVC	FOCPG	TQCPG	FOCPM	Factory setting: 60.0
Settings	30.0 to 600.0 sec						

-  The parameter is set by the output frequency, current and operation time of the drive for activating the I²t electronic thermal protection function. The function will be activated for the 150% * setting current for the setting of Pr.06-13.

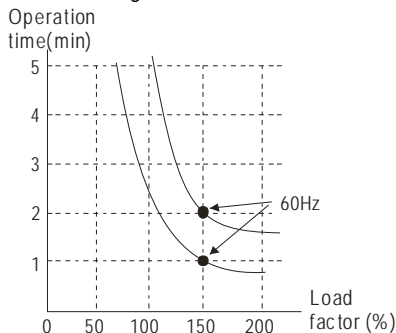

06-14 Heat Sink Over-heat (OH) Warning

Control mode	VF	VFP	SVC	FOCPG	TQCPG	FOCPM	Factory setting: 85.0
Settings	0.0 to 110.0 °C						

06-15 Stall Prevention Limit Level

Control mode	VF	VFP	SVC	Factory setting: 50
Settings	0 to 100% (refer to Pr.06-02, Pr.06-03)			

-  When the operating frequency is larger than Pr.01-01, Pr06-02=150%, Pr. 06-03=100% and Pr. 06-15=80%:

Stall Prevention Level during acceleration = $06-02 \times 06-15 = 150 \times 80\% = 120\%$.

Stall Prevention Level at constant speed = $06-03 \times 06-15 = 100 \times 80\% = 80\%$.

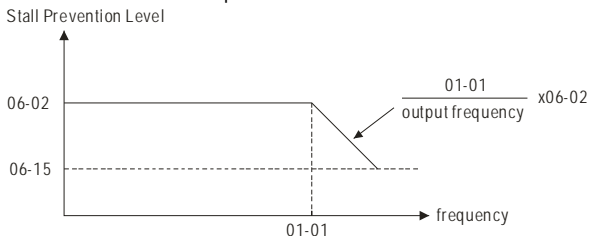

06-16	Present Fault Record						
06-17	Second Most Recent Fault Record						
06-18	Third Most Recent Fault Record						
06-19	Fourth Recent Fault Record						
06-20	Fifth Most Recent Fault Record						
06-21	Sixth Most Recent Fault Record						
Control mode	VF	VFGP	SVC	FOCPG	TQCPG	FOCPM	Factory setting: 0
Readings	0	No fault					
	1	Over-current during acceleration (ocA)					
	2	Over-current during deceleration (ocd)					
	3	Over-current during constant speed (ocn)					
	4	Ground fault (GFF)					
	5	IGBT short-circuit (occ)					
	6	Over-current at stop (ocS)					
	7	Over-voltage during acceleration (ovA)					
	8	Over-voltage during deceleration (ovd)					
	9	Over-voltage during constant speed (ovn)					
	10	Over-voltage at stop (ovS)					
	11	Low-voltage during acceleration (LvA)					
	12	Low-voltage during deceleration (Lvd)					
	13	Low-voltage during constant speed (Lvn)					
	14	Low-voltage at stop (LvS)					
	15	Phase loss (PHL)					
	16	IGBT heat sink over-heat (oH1)					
	17	Heat sink over-heat (oH2)(for 40HP above)					
	18	TH1 open loop error (tH1o)					
	19	TH2 open loop error (tH2o)					
	20	Fan error signal output					
	21	Over-load (oL) (150% 1Min)					
	22	Motor over-load (EoL1)					
	23	Reserved					
	24	Motor PTC overheat (oH3)					
	25	Reserved					
	26	Over-torque 1 (ot1)					
	27	Over-torque 1 (ot2)					
	28	Reserved					

29	Reserved
30	Memory write-in error (cF1)
31	Memory read-out error (cF2)
32	Isum current detection error (cd0)
33	U-phase current detection error (cd1)
34	V-phase current detection error (cd2)
35	W-phase current detection error (cd3)
36	Clamp current detection error (Hd0)
37	Over-current detection error (Hd1)
38	Over-voltage detection error (Hd2)
39	Ground current detection error (Hd3)
40	Auto tuning error (AuE)
41	PID feedback loss (AFE)
42	PG feedback error (PGF1)
43	PG feedback loss (PGF2)
44	PG feedback stall (PGF3)
45	PG slip error (PGF4)
46	PG ref input error (PGr1)
47	PG ref loss (PGr2)
48	Analog current input error (ACE)
49	External fault input (EF)
50	Emergency stop (EF1)
51	Reserved
52	Password error (PcodE)
53	Reserved
54	Communication error (cE1)
55	Communication error (cE2)
56	Communication error (cE3)
57	Communication error (cE4)
58	Communication Time-out (cE10)

59	PU time-out (cP10)
60	Brake chopper error (bF)
61-62	Reserved
63	Safety loop error (Sry)
64	Mechanical brake error (MBF)
65	PGF5 hardware error
66	Magnetic contactor error (MCF)
67	Phase loss of drive output (MPHL)

 It will record when the fault occurs and force stopping. For the Lv, it will record when it is operation, or it will warn without record.

06-30 Setting Method of Fault Output

Control mode	VF	VFPG	SVC	FOCPG	TQCPG	FOCPM	Factory setting: 0
Settings		0		By settings of Pr.06-22~06-25			
		1		By the binary setting			

 It is used with the settings 35~38 of Pr.02-11~02-22 (Multi-function Output). The fault output selection 1~4 corresponds to Bit 0~3.

 This parameter provides two setting methods for the fault output: setting 0: it is set by the settings of Pr.06-22~Pr.06-25; setting 1: it is set by the binary setting and please refer to the following example for details.

Example:

Assume that

Pr.02-15 (Multi-function Output 5 (MO3)) is set to 35 Fault output option 1 (Pr.06-22).

Pr.02-17 (Multi-function Output 7 (MO5)) is set to 36 Fault output option 2 (Pr.06-23).

Pr.02-19 (Multi-function Output 9 (MO7)) is set to 37 Fault output option 3 (Pr.06-24).

Pr.02-21 (Multi-function Output 11 (MO9)) is set to 38 Fault output option 4 (Pr.06-25).

Assume that external faults output with the following signal: MO3=1, MO5=1, MO7=0 and MO9=1. The corresponding Bit 3~0 is 1011.

Bit 3	Bit 2	Bit 1	Bit 0	Fault code
-	-	-	-	0: No fault
0	0	0	1	1: Over-current during acceleration (ocA)
				2: Over-current during deceleration (ocd)
				3: Over-current during constant speed (ocn)
				4: Ground fault (GFF)
				5: IGBT short-circuit (occ)

Bit 3	Bit 2	Bit 1	Bit 0	Fault code
				6: Over-current at stop (ocS)
0	0	1	0	7: Over-voltage during acceleration (ovA) 8: Over-voltage during deceleration (ovd) 9: Over-voltage during constant speed (ovn) 10: Over-voltage at stop (ovS)
0	0	1	1	11: Low-voltage during acceleration (LvA) 12: Low-voltage during deceleration (Lvd) 13: Low-voltage during constant speed (Lvn) 14: Low-voltage at stop (LvS) 15: Phase loss (PHL)
0	1	0	0	16: IGBT heat sink over-heat (oH1) 17: Heat sink over-heat (oH2)(for 40HP above) 18: TH1 open loop error (tH1o) 19: TH2 open loop error (tH2o)
1	0	0	0	20: Fan error signal output
0	1	0	1	21: over-load (oL) (150% 1Min)
0	1	1	0	22: Motor 1 over-load (EoL1) 24: Motor PTC overheat (oH3)
0	1	1	1	26: over-torque 1 (ot1) 27: over-torque 1 (ot2)
1	0	0	0	30: Memory write-in error (cF1) 31: Memory read-out error (cF2) 32: Isum current detection error (cd0) 33: U-phase current detection error (cd1) 34: V-phase current detection error (cd2) 35: W-phase current detection error (cd3) 36: Clamp current detection error (Hd0) 37: Over-current detection error (Hd1) 38: Over-voltage detection error (Hd2) 39: Ground current detection error (Hd3)
1	0	0	1	40: Auto tuning error (AuE)
1	0	1	0	41: PID feedback loss (AFE) 42: PG feedback error (PGF1) 43: PG feedback loss (PGF2)
0	1	1	1	44: PG feedback stall (PGF3)
1	0	1	0	45: PG slip error (PGF4) 46: PG ref input error (PGr1) 47: PG ref loss (PGr2)
1	0	1	1	48: Analog current input error (ACE) 49: External fault input (EF) 50: Emergency stop (EF1)
1	0	0	1	52: Password error (PcodE)
1	1	0	0	54: Communication error (cE1) 55: Communication error (cE2) 56: Communication error (cE3) 57: Communication error (cE4) 58: Communication Time-out (cE10) 59: PU time-out (cP10)
1	0	0	0	60: Brake chopper error (bF)
1	0	1	1	63: Safety loop error (Sry)

Bit 3	Bit 2	Bit 1	Bit 0	Fault code
1	0	0	0	64: Mechanical brake error (MBF)
1	0	1	1	65: PGF5 hardware error
1	0	1	1	66: Magnetic contactor error (MCF)
1	0	1	1	67: Phase loss of drive output (MPHL)

06-22 ✎ Fault Output Option 1

06-23 ✎ Fault Output Option 2

06-24 ✎ Fault Output Option 3

06-25 ✎ Fault Output Option 4

Control mode VF VFPG SVC FOCPG TQCPG FOCPM Factory setting: 0

Settings 0 to 65535 sec (refer to bit table for fault code)

 These parameters can be used with multi-function output (set Pr.02-11 to Pr.02-22 to 35-38) for the specific requirement. When the fault occurs, the corresponding terminals will be activated (It needs to convert binary value to decimal value to fill in Pr.06-22 to Pr.06-25).

Fault code	Bit0	Bit1	Bit2	Bit3	Bit4	Bit5	Bit6
	current	Volt.	OL	SYS	FBK	EXI	CE
0: No fault							
1: Over-current during acceleration (ocA)	●						
2: Over-current during deceleration (ocd)	●						
3: Over-current during constant speed (ocn)	●						
4: Ground fault (GFF)						●	
5: IGBT short-circuit (occ)	●						
6: Over-current at stop (ocS)	●						
7: Over-voltage during acceleration (ovA)		●					
8: Over-voltage during deceleration (ovd)		●					
9: Over-voltage during constant speed (ovn)		●					
10: Over-voltage at stop (ovS)		●					

Fault code	Bit0	Bit1	Bit2	Bit3	Bit4	Bit5	Bit6
	current	Volt.	OL	SYS	FBK	EXI	CE
11: Low-voltage during acceleration (LvA)		●					
12: Low-voltage during deceleration (Lvd)		●					
13: Low-voltage during constant speed (Lvn)		●					
14: Low-voltage at stop (LvS)		●					
15: Phase loss (PHL)						●	
16: IGBT heat sink over-heat (oH1)			●				
17: Heat sink over-heat (oH2)(for 40HP above)			●				
18: TH1 open loop error (tH1o)			●				
19: TH2 open loop error (tH2o)			●				
20: Fan error signal output						●	
21: over-load (oL) (150% 1Min)			●				
22: Motor 1 over-load (EoL1)			●				
23: Reserved							
24: Motor PTC overheat (oH3)			●				
25: Reserved							
26: over-torque 1 (ot1)			●				
27: over-torque 1 (ot2)			●				
28: Reserved							
29: Reserved							
30: Memory write-in error (cF1)				●			
31: Memory read-out error (cF2)				●			
32: Isum current detection error (cd0)				●			
33: U-phase current detection error (cd1)				●			
34: V-phase current detection error (cd2)				●			

Fault code	Bit0	Bit1	Bit2	Bit3	Bit4	Bit5	Bit6
	current	Volt.	OL	SYS	FBK	EXI	CE
35: W-phase current detection error (cd3)				●			
36: Clamp current detection error (Hd0)				●			
37: Over-current detection error (Hd1)				●			
38: Over-voltage detection error (Hd2)				●			
39: Ground current detection error (Hd3)				●			
40: Auto tuning error (AuE)				●			
41: PID feedback loss (AFE)					●		
42: PG feedback error (PGF1)					●		
43: PG feedback loss (PGF2)					●		
44: PG feedback stall (PGF3)					●		
45: PG slip error (PGF4)					●		
46: PG ref input error (PGr1)					●		
47: PG ref loss (PGr2)						●	
48: Analog current input error (ACE)						●	
49: External fault input (EF)						●	
50: Emergency stop (EF1)						●	
51: Reserved							
52: Password error (PcodE)				●			
53: Reserved							
54: Communication error (cE1)							●
55: Communication error (cE2)							●
56: Communication error (cE3)							●
57: Communication error (cE4)							●
58: Communication Time-out (cE10)							●
59: PU time-out (cP10)							●

Fault code	Bit0	Bit1	Bit2	Bit3	Bit4	Bit5	Bit6
	current	Volt.	OL	SYS	FBK	EXI	CE
60: Brake chopper error (bF)						●	
61-62: Reserved							
63: Safety loop error (Sry)				●			
64: Mechanical brake error (MBF)						●	
65: PGF5 hardware error				●			
66: Magnetic contactor error (MCF)						●	
67: Phase loss of drive output (MPHL)						●	

06-26 ✓ PTC (Positive Temperature Coefficient) Detection Selection

Control mode	VF	VFPG	SVC	FOCPG	TQCPG	FOCPM	Factory setting:
Settings	0		Warn and keep operating				0
	1		Warn and ramp to stop				

 It is used to set the treatment after detecting PTC.

06-27 ✓ PTC Level

Control mode	VF	VFPG	SVC	FOCPG	TQCPG	FOCPM	Factory setting:
Settings		0.0 to 100.0%					50.0

 It is used to set the PTC level, and the corresponding value for 100% is max. analog input value.

06-28 ✓ Filter Time for PTC Detection

Control mode	VF	VFPG	SVC	FOCPG	TQCPG	FOCPM	Factory setting:
Settings		0.00 to 10.00 sec					0.20

06-29 Voltage of Emergency Power

Control mode	VF	VFPG	SVC	FOCPG	TQCPG	FOCPM	Factory setting:
Settings		48.0~375.0Vdc					48.0/96.0
		96.0~750.0Vdc					

-  It is used with the setting 43 (EPS function) of Pr.02-01~02-08 (Multi-Function Input Command).

06-31	Phase Loss Detection of Drive Output at Start-Up(MPHL)						Factory setting: 0
Control mode	VF	VFPG	SVC	FOCPG	TQCPG	FOCPM	
	Settings	0	Disable				
		1	Enable				

-  When it is set to 1, it will auto detect if the connection between the drive and motor is normal whenever the drive runs. If errors occur to the connection between the drive and the motor, the drive will display fault code "67" to indicate motor output phase loss.

06-32	Accumulative Drive Power-on Time at the First Fault (min.)						
06-34	Accumulative Drive Power-on Time at the Second Fault (min.)						
06-36	Accumulative Drive Power-on Time at the Third Fault (min.)						
06-38	Accumulative Drive Power-on Time at the Fourth Fault (min.)						
06-40	Accumulative Drive Power-on Time at the Fifth Fault (min.)						
06-42	Accumulative Drive Power-on Time at the Sixth Fault (min.)						
Control mode	VF	VFPG	SVC	FOCPG	TQCPG	FOCPM	Factory setting: 0
	Settings	00 to 1439 min					

06-33	Accumulative Drive Power-on Time at the First Fault (day)						
06-35	Accumulative Drive Power-on Time at the Second Fault (day)						
06-37	Accumulative Drive Power-on Time at the Third Fault (day)						
06-39	Accumulative Drive Power-on Time at the Fourth Fault (day)						
06-41	Accumulative Drive Power-on Time at the Fifth Fault (day)						
06-43	Accumulative Drive Power-on Time at the Sixth Fault (day)						
Control mode	VF	VFPG	SVC	FOCPG	TQCPG	FOCPM	Factory setting: 0
	Settings	00 to 65535 day					

06-44	⚡ Operation Speed of Emergency Power Mode						
Control mode	VF	VFPG	SVC	FOCPG	TQCPG	FOCPM	Factory setting: 0.00
	Settings	0.00 to 400.00Hz					

📖 Max. operation speed F_{EPS} in emergency power mode:

$$F_{EPS} = 06-29/01-02 * (1/\sqrt{2}) * 01-01 * (1/2)$$

When $Pr.06-44 > F_{EPS}$, the speed in emergency power mode will be operated by F_{EPS} .

When $Pr.06-44 \leq F_{EPS}$, the speed in emergency power mode will be operated by $Pr.06-44$.

06-45 Low-voltage Protection

Control mode	VF	VFPG	SVC	FOCPG	TQCPG	FOCPM	Factory setting:
Settings		0	Display Lv fault and coast to stop				0
		1	Display Lv warn and coast to stop				
		2	Fan lock, fault and coast to stop				
		3	Fan lock, warn and coast to stop				

06-46 Low-voltage Protection

Control mode	VF	VFPG	SVC	FOCPG	TQCPG	FOCPM	Factory setting:
Settings		0	Operate by current command				0
		1	Operate by the direction of power generating mode				

📖 Pr.06-46 is enabled when the external terminal is detecting for the emergency power.

📖 When Pr.06-46 is set to 1 and a forward/reverse run command is given, the drive will begin to detect for the elevator loading and operates in the power regeneration direction (the motor is in power generating status). The drive will use and operate in the direction that was detected as its power regeneration direction. The drive will not operate in user command direction for safety purpose, to prevent voltage drop of emergency power.

📖 VF and SVC control mode: within the time setting of Pr.06-47, the drive detects the elevator loading status by performing forward/reverse run. Then the elevator operates in power regeneration direction (the motor id in power generating status). Refer to the diagram below for the Auto-Detection Time Graph.

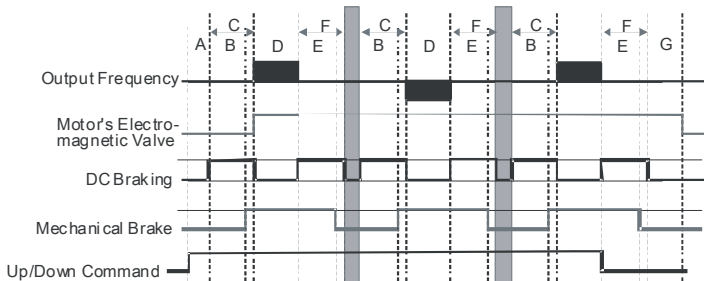
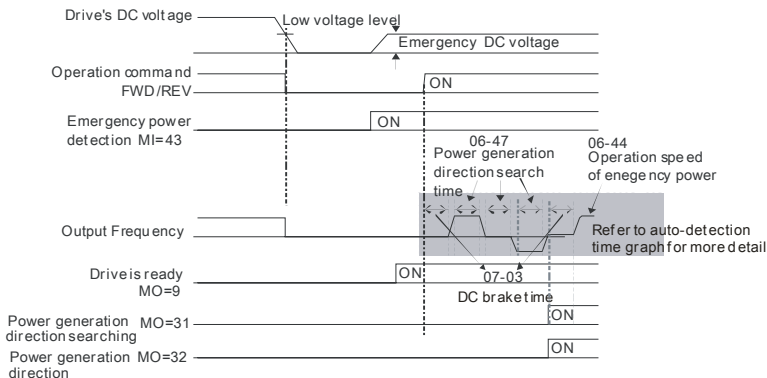

- A 02-31: Turn On Delay of Magnetic Contactor between Drive and Motor
- B 02-29: Brake Release Delay Time when Elevator Starts
- C 07-03: DC Brake Activation Time
- D 06-47: Power Generation Direction Searching Time
- E 02-30: Brake Engage Delay Time when Elevator Stops
- F 07-04: Require DC Brake Time to Stop
- G 02-32: Turn Off Delay of Magnetic Contactor between Drive and Motor

Auto-detection Time Graph

FOCPG/PM Control Mode: within the time setting of Pr.06-47, the drive maintains at zero-speed and it is able to determine the elevator loading without performing forward/reverse run. Then the elevator operates in power regeneration direction (the motor is in power generating status). Refer to the diagram below for the Auto-Detection Time Graph.

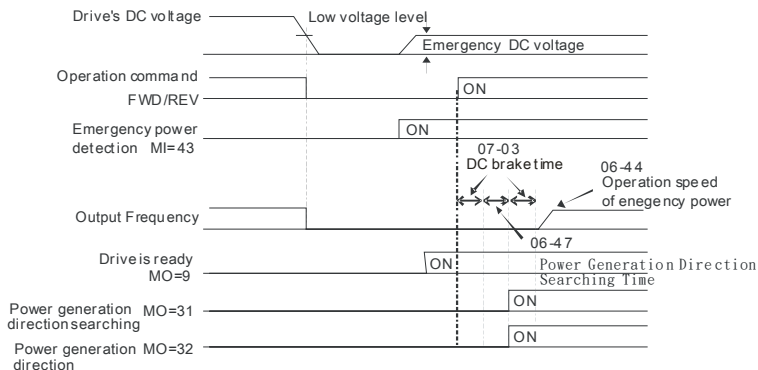
**06-47** ✓ Power Generation Direction Searching Time

Control mode	VF	VFP	SVC	FOCPG	TQCPG	FOCPM	Factory setting: 1.0
Settings	0.0~5.0 sec						

06-48 ✓ Power Capacity of Emergency Power

Control mode	VF	VFP	SVC	FOCPG	TQCPG	FOCPM	Factory setting: 0.0
Settings	0.0~100.0 kVA						

- When using emergency power, user must input the required power capacity for the emergency power and then the AC drive will calculate the acceptable elevator speed (Pr.06-44) by following equation.

$$V_{eps_max} = \frac{06-48 \times 0.5}{\sqrt{3} \times I_{motor_rated}}$$

$$f_{eps_limit} = \frac{V_{eps_max}}{01-02} \times 01-01 \times 0.5$$

$$I_{motor_rated} = 05-01 \text{ (Induction Motor)} / 08-01 \text{ (PM Motor)}$$

- When Frequency Command > f_{EPS}, the operation speed of emergency power is f_{EPS}.
- When Frequency Command ≤ f_{EPS}, the operation speed of emergency power is set by current frequency command.

4.2.8 Group 7 Special Parameters

07-00 Brake Chopper Level

Control mode	VF	VFPG	SVC	FOCPG	TQCPG	FOCPM	
Settings	230V series	350.0~450.0Vdc					Factory Setting: 380.0
	460V series	700.0~900.0Vdc					Factory Setting: 760.0

 This parameter sets the DC-bus voltage at which the brake chopper is activated.

07-01 Reserved

07-02 DC Brake Current Level

Control mode	VF	VFPG	SVC				Factory Setting: 0
Settings		0 to 100%					

 This parameter sets the level of DC Brake Current output to the motor during start-up and stopping. When setting DC Brake Current, the Rated Current (Pr.00-01) is regarded as 100%. It is recommended to start with a low DC Brake Current Level and then increase until proper holding torque has been attained.

 When it is in FOCPG/TQCPG/FOCPM mode, it can enable DC brake function by setting to any value.

07-03 DC Brake Activation Time

Control mode	VF	VFPG	SVC	FOCPG	FOCPM		Factory Setting: 0.0
Settings		0.0 to 60.0 sec					

 This parameter sets the duration of DC Brake current is supplied to motor when activating the drive.

07-04 DC Brake Stopping Time

Control mode	VF	VFPG	SVC	FOCPG	FOCPM		Factory Setting: 0.0
Settings		0.0 to 60.0 sec					

 This parameter sets the duration of DC Brake current is supplied to motor when stopping the drive.

07-05 / Start-Point for DC Brake

Control mode	VF	VFPG	SVC	FOCPG
--------------	----	------	-----	-------

Factory Setting: 0.00

Settings 0.00 to 400.00Hz

 This parameter determines the frequency when DC Brake will begin during deceleration. When the setting is less than start frequency (Pr.01-09), start-point for DC brake will begin from the min. frequency.

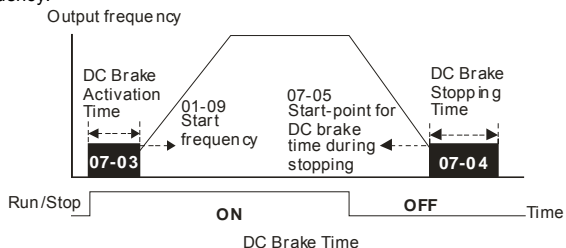
**07-06** DC Brake Proportional Gain

Control mode	VF	VFPG	SVC
--------------	----	------	-----

Factory Setting: 50

Settings 1 to 500Hz

 It is used to set the output voltage gain when DC brake.

07-07 / Dwell Time at Accel.

Control mode	VF	VFPG	SVC	FOCPG	FOCPM
--------------	----	------	-----	-------	-------

Factory Setting: 0.00

Settings 0.00 to 600.00 sec

07-08 / Dwell Frequency at Accel.

Control mode	VF	VFPG	SVC	FOCPG	FOCPM
--------------	----	------	-----	-------	-------

Factory Setting: 0.00

Settings 0.00 to 400.00 Hz

07-09 / Dwell Time at Decel.

Control mode	VF	VFPG	SVC	FOCPG	FOCPM
--------------	----	------	-----	-------	-------

Factory Setting: 0.00

Settings 0.00 to 600.00 sec

07-10 / Dwell Frequency at Decel.

Control mode	VF	VFPG	SVC	FOCPG	FOCPM
--------------	----	------	-----	-------	-------

Factory Setting: 0.00

Settings 0.00 to 400.00 Hz

 In the heavy load situation, Dwell can make stable output frequency temporarily.

Pr.07-07 to Pr.07-10 are for heavy load to prevent OV or OC occurs.

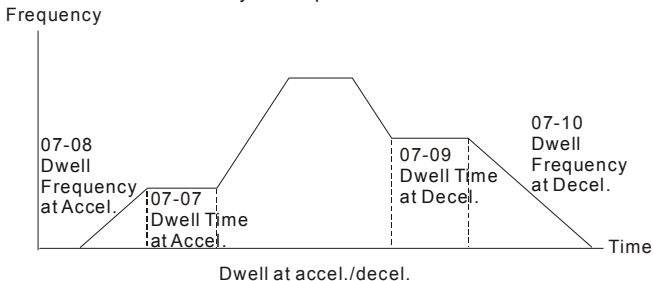

07-11 Fan Control

Control mode	VF	VFPG	SVC	FOCPG	TQCPG	FOCPM	Factory Setting: 2
Settings		0	Fan always ON				
		1	1 minute after AC motor drive stops, fan will be OFF				
		2	AC motor drive runs and fan ON, AC motor drive stops and fan OFF				
		3	Fan ON to run when preliminary heat sink temperature attained				
		4	Fan always OFF				

This parameter is used for the fan control.

When setting to 3, fan will start to run until temperature is less than 40°C if temperature exceeds 40°C.

07-12 Torque Command

Control mode	TQCPG	Factory Setting: 0.0
Settings	-100.0 to 100.0% (Pr. 07-14 setting=100%)	

This parameter is torque command. When Pr.07-14 is 250% and Pr.07-12 is 100%, the actual torque command = 250X100% X motor rated torque.

07-13 Torque Command Source

Control mode	TQCPG	Factory Setting: 2
Settings	0	Digital keypad
	1	RS485 serial communication (RJ-11)
	2	Analog signal (Pr.03-00)

This parameter is torque command source and the torque command is in Pr.07-12.

07-14 / Maximum Torque Command

Control mode	VF	VFPG	SVC	FOCPG	TQCPG	FOCPM	Factory Setting: 100
Settings	0 to 300%						

 This parameter is for the max. torque command (motor rated torque is 100%).

07-15 / Filter Time of Torque Command

Control mode	TQCPG	Factory Setting: 0.000
Settings	0.000 to 1.000 sec	

 When the setting is too long, the control will be stable but the control response will be delay.
When the setting is too short, the response will be quickly but the control maybe unstable.
User can adjust the setting by the control and response situation.

07-16 Speed Limit Selection

Control mode	TQCPG	Factory Setting: 0
Settings	0	By Pr.07-17 and Pr.07-18
	1	Frequency command source (Pr.00-14)

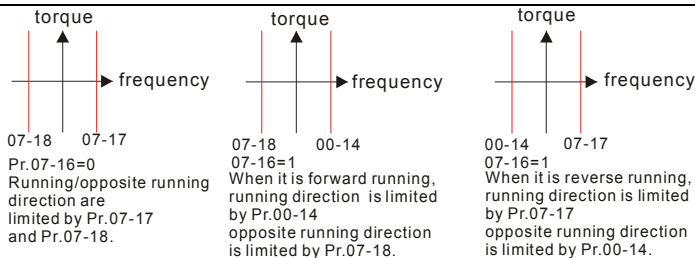
**07-17** / Torque Mode+Speed Limit**07-18** / Torque Mode-Speed Limit

Control mode	TQCPG	Factory Setting: 10
Settings	0 to 120%	

 These parameters are used in the torque mode to limit the running direction and opposite direction. (Pr.01-00 max. output frequency=100%)

07-19  Source of Torque Offset

Control mode	SVC	FOCPG	TQCPG	FOCPM	Factory Setting: 0
Settings	0		Disable		
	1		Analog input (Pr.03-00)		
	2		Torque offset setting (Pr.07-20)		
	3		Control by external terminal (by Pr.07-21 to Pr.07-23)		

 This parameter is the source of torque offset.

 When it is set to 3, the source of torque offset will decide to Pr.07-21, Pr.07-22 and Pr.07-23 by the multi-function input terminals setting (31, 32 or 33).

02-01~02-08 is set to 31	02-01~02-08 is set to 32	02-01~02-08 is set to 33	Torque offset
OFF	OFF	OFF	None
OFF	OFF	ON	07-23
OFF	ON	OFF	07-22
OFF	ON	ON	07-23+07-22
ON	OFF	OFF	07-21
ON	OFF	ON	07-21+07-23
ON	ON	OFF	07-21+07-22
ON	ON	ON	07-21+07-22+07-23

07-20  Torque Offset Setting

Control mode	SVC	FOCPG	TQCPG	FOCPM	Factory Setting: 0.0
Settings		0.0 to 100.0%			

 This parameter is torque offset. The motor rated torque is 100%.

07-21  High Torque Offset

Control mode	SVC	FOCPG	TQCPG	FOCPM	Factory Setting: 30.0
Settings		0.0 to 100.0%			

07-22  Middle Torque Offset

Control mode	SVC	FOCPG	TQCPG	FOCPM	Factory Setting: 20.0
Settings		0.0 to 100.0%			

07-23 / Low Torque Offset

Control mode SVC FOC PG TQCPG FOC PM

Factory Setting: 10.0

Settings 0.0 to 100.0%

When it is set to 3, the source of torque offset will decide to Pr.07-21, Pr.07-22 and Pr.07-23 by the multi-function input terminals setting (19, 20 or 21). The motor rated torque is 100%.

07-24 / Forward Motor Torque Limit**07-25** / Forward Regenerative Torque Limit**07-26** / Reverse Motor Torque Limit**07-27** / Reverse Regenerative Torque Limit

Control mode FOC PG TQCPG FOC PM

Factory Setting: 200

Settings 0 to 300%

The motor rated torque is 100%. The settings for Pr.07-24 to Pr.07-27 will compare with Pr.03-00=5, 6, 7, 8. The minimum of the comparison result will be torque limit.

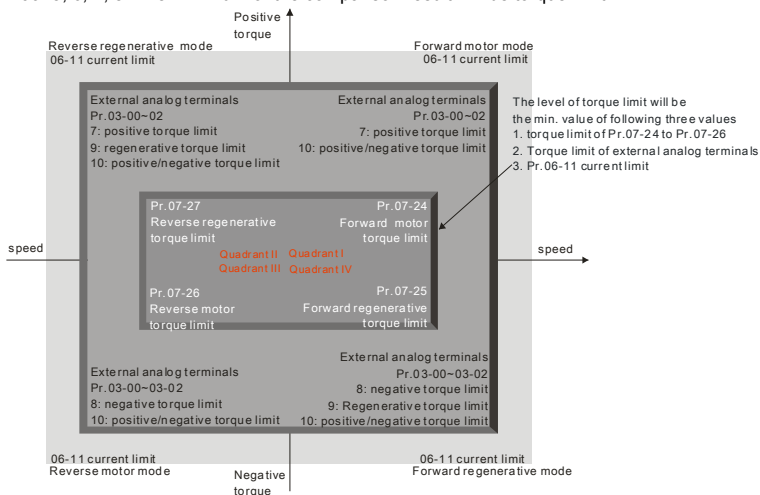

07-28 Emergency Stop (EF) & Forced Stop Selection

Control mode	VF	VFPG	SVC	FOCPG	TQCPG	FOCPM	Factory Setting: 0
Settings			0	Coast to stop			
			1	By deceleration Time 1			
			2	By deceleration Time 2			
			3	By deceleration Time 3			
			4	By deceleration Time 4			
			5	By Pr.01-31			

When the multi-function input terminal is set to 10 or 14 and it is ON, the AC motor drive will be operated by Pr.07-28.

07-29 Time for Decreasing Torque at Stop

Control mode	FOCPG	TQCPG	FOCPM	Factory Setting: 0.000
Settings	0.000 to 1.000 sec			

When the elevator is stop and the mechanical brake is engaged, the drive will stop output. At the same time, it will produce the noise from the reacting force between the motor and the mechanical brake. This parameter can be used to decrease this reacting force and lower the noise.

It is used to set the time for decreasing torque to 0%.

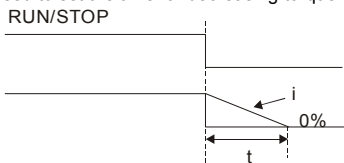

$$\frac{i}{100-0} \times \frac{100\%}{300\%} \times (07-29) = t$$

4.2.9 Group 8 PM Parameters

08-00	Motor Auto Tuning	
Control mode	FOCPM	Factory setting: 0
	Settings	
	0	No function
	1	Only for the unloaded motor, auto measure the angle between magnetic pole and PG origin (08-09)
	2	For PM parameters
	3	Auto measure the angle between magnetic pole and PG origin (08-09)



For setting 1: It can auto measure the angle between magnetic pole and PG origin. Please notice the following items when measuring:

1. Please unload before tuning.
2. If brake is controlled by drive, the drive will act by the normal operation to finish tuning after wiring and setting brake control parameters.
3. If brake is controlled by the host controller, it needs to make sure that brake is in release state before tuning.
4. Make sure the setting of Pr.10-02 is correct. Because the wrong setting of Pr.10-02 will cause wrong position of magnetic pole and also the wrong angle between magnetic pole and PG origin.



For setting 2: Starting auto tuning by pressing RUN key and it will write the measure value into Pr.08-05, Pr.08-07 (Rs, Lq) and Pr.08-08 (back EMF).

The steps to AUTO-Tuning are: (Dynamic measure)

1. Make sure that all the parameters are set to factory settings and the motor wiring is correct.
2. Motor: Fill in Pr.08-01, Pr.08-02, Pr.08-03 and Pr.08-04 with correct values. Refer to motor capacity to set accel./decel. time.
3. When Pr.08-00 is set to 2, the AC motor drive will execute auto-tuning immediately after receiving a "RUN" command. (NOTE: the motor will run! The shaft needs to be locked with external force.)
4. After executing, please check if all values are filled in Pr.08-05 and Pr.08-07.



For setting 3: It can auto measure the angle between magnetic pole and PG origin. Please notice the following items when measuring:

1. It can be loaded motor or unloaded motor before tuning.

2. If brake is controlled by drive, the drive will act by the normal operation to finish tuning after wiring and setting brake control parameters.
3. If brake is controlled by the host controller, it needs to make sure that brake is in release state before tuning.

 **NOTE**

- The rated speed can't be larger or equal to 120f/p.
- Please notice that if the electromagnetic valve and brake is not controlled by the AC motor drive, please release it by manual.
- It is recommended to set Pr.08-00 to 1 (unloaded motor) for the accurate calculation. If it needs to execute this function with loaded motor, please balance the carriage before execution.
- if it doesn't allow balancing the carriage in the measured environment, it can set Pr.08-00=3 for executing this function. It can execute this function with loaded motor by setting Pr.08-00=3. It will have a difference of 15~30° by the different encoder type.
- It will display the warning message "Auto tuning" on the digital keypad during measuring until the measure is finished. Then, the result will be saved into Pr.08-09.
- It will display "Auto Tuning Err" on the keypad when stopping by the fault of the AC motor drive or human factor to show the failed detection. At this moment, please check the connections of the wirings of the AC motor drives. If it displays "PG Fbk Error" on the digital keypad, please change the setting of Pr.10-02 (if it is set to 1, please change it to 2). If it displays "PG Fbk Loss" on the digital keypad, please check the feedback of Z-phase pulse.

08-01	Full-load Current of Motor	Unit: Amper
Control mode	FOCPM	Factory setting: ##
	Settings	(40 to 120%)*Pr.00-01 Amps

 This value should be set according to the rated frequency of the motor as indicated on the motor nameplate. The factory setting is 90% X rated current.

Example: if the rated current for 7.5hp (5.5kW) models is 25A and the factory setting is 22.5A. In this way, the current range will be from 10A (25*40%) to 30A (25*120%).

08-02	✓ Rated Power of Motor
Control mode	FOCPM Factory setting: #.##
Settings	0.00 to 655.35 kW

 It is used to set rated power of the motor. The factory setting is the power of the drive.

08-03	✓ Rated Speed of Motor (rpm)
Control mode	FOCPM Factory setting: 1710
Settings	0 to 65535 rpm

 It is used to set the rated speed of the motor and need to set according to the value indicated on the motor nameplate.

08-04	Number of Motor Poles
Control mode	FOCPM Factory setting: 4
Settings	2 to 96

 It is used to set the number of motor poles (must be an even number).

08-05	Rs of Motor
Control mode	FOCPM Factory setting: 0.000
Settings	0.000~65.535Ω

08-06	Ld of Motor
Control mode	FOCPM Factory setting: 0.0

08-07	Lq of Motor
Control mode	FOCPM Factory setting: 0.0
Settings	0.0~6553.5mH

08-08	Back Electromotive Force
Control mode	FOCPM Factory setting: 0.0
Settings	0.0~6553.5Vrms

 This parameter is used to set back electromotive force (phase-phase RMS value) when the motor is operated in the rated speed.

 It can get RMS value by Pr.08-00=2 (Motor Auto Tuning).

08-09	Angle between Magnetic Pole and PG Origin	
Control mode	FOCPM	Factory setting: 360.0
Settings	0.0~360.0°	

 This function is used to measure the angle between magnetic pole and PG origin.

08-10	Magnetic Pole Re-orientation	
Control mode	FOCPM	Factory setting: 0
Settings	0	Disable
	1	Enable

 Please use with Pr.11-00 bit15=1.

 This function is used for searching magnetic pole position and only for permanent magnet motor.

 When it doesn't have origin-adjustment for encoder (Pr.08-09 is 360.0), it can only ensure that the motor operation efficiency can be up to 86% of the best efficiency. In this situation, when the operation efficiency needs to be improved, user can re-power on or set Pr.08-10 to 1 to get the magnetic pole orientation.

4.2.10 Group 9: Communication Parameters

When the AC motor drive is controlled by RS-485 serial communication, a converter, VFD-USB01 or IFD8500, should be connected between the AC motor drive and PC.

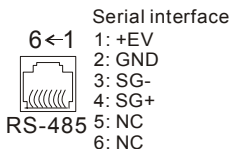

09-00 ✓ Communication Address

Control mode	VF	VFPG	SVC	FOCPG	TQCPG	FOCPM	Factory Setting:
							1
Settings		1 to 254					

- If the AC motor drive is controlled by RS-485 serial communication, the communication address for this drive must be set via this parameter. And the communication address for each AC motor drive must be different and unique.

09-01 ✓ Transmission Speed

Control mode	VF	VFPG	SVC	FOCPG	TQCPG	FOCPM	Factory Setting:
							9.6
Settings		4.8 to 115.2kbps					

- This parameter is used to set the transmission speed between the RS485 master (PLC, PC, etc.) and AC motor drive.

09-02 ✓ Transmission Fault Treatment

Control mode	VF	VFPG	SVC	FOCPG	TQCPG	FOCPM	Factory Setting:
							3
Settings		0	Warn and keep operating				
		1	Warn and RAMP to stop				
		2	Reserved				
		3	No action and no display				

- This parameter is set to how to react if transmission errors occur.

09-03 ✓ Time-out Detection

Control mode	VF	VFPG	SVC	FOCPG	TQCPG	FOCPM	Factory Setting:
							0.0
Settings		0.0 ~ 100.0 sec (0.0: disable)					

- It is used to set the communication time-out time.

09-04 Communication Protocol

Control mode	VF	VFPG	SVC	FOCPG	TQCPG	FOCPM	Factory Setting: 13
Settings		0		Modbus ASCII mode, protocol <7,N,1>			
		1		Modbus ASCII mode, protocol <7,N,2>			
		2		Modbus ASCII mode, protocol <7,E,1>			
		3		Modbus ASCII mode, protocol <7,O,1>			
		4		Modbus ASCII mode, protocol <7,E,2>			
		5		Modbus ASCII mode, protocol <7,O,2>			
		6		Modbus ASCII mode, protocol <8,N,1>			
		7		Modbus ASCII mode, protocol <8,N,2>			
		8		Modbus ASCII mode, protocol <8,E,1>			
		9		Modbus ASCII mode, protocol <8,O,1>			
		10		Modbus ASCII mode, protocol <8,E,2>			
		11		Modbus ASCII mode, protocol <8,O,2>			
		12		Modbus RTU mode, protocol <8,N,1>			
		13		Modbus RTU mode, protocol <8,N,2>			
		14		Modbus RTU mode, protocol <8,E,1>			
		15		Modbus RTU mode, protocol <8,O,1>			
		16		Modbus RTU mode, protocol <8,E,2>			
	17		Modbus RTU mode, protocol <8,O,2>				

1. Control by PC or PLC

★ A VFD-VL can be set up to communicate on Modbus networks using one of the following modes: ASCII (American Standard Code for Information Interchange) or RTU (Remote Terminal Unit).

Users can select the desired mode along with the serial port communication protocol in Pr.09-04.

★ Code Description:

ASCII mode:

Each 8-bit data is the combination of two ASCII characters. For example, a 1-byte data:

64 Hex, shown as '64' in ASCII, consists of '6' (36Hex) and '4' (34Hex).

Character	'0'	'1'	'2'	'3'	'4'	'5'	'6'	'7'
ASCII code	30H	31H	32H	33H	34H	35H	36H	37H

Character	'8'	'9'	'A'	'B'	'C'	'D'	'E'	'F'
ASCII code	38H	39H	41H	42H	43H	44H	45H	46H

RTU mode:

Each 8-bit data is the combination of two 4-bit hexadecimal characters. For example, 64 Hex.

2. Data Format

10-bit character frame (For ASCII):
(7.N.2)

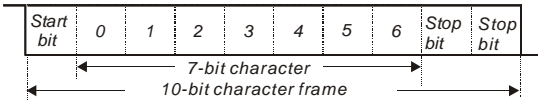

(7.E.1)

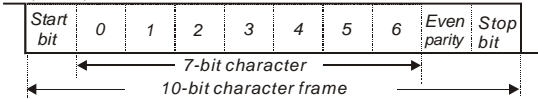

(7.O.1)

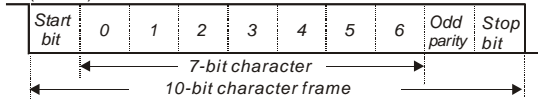

11-bit character frame (For RTU):
(8.N.2)

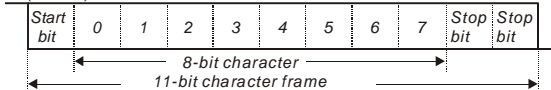

(8.E.1)

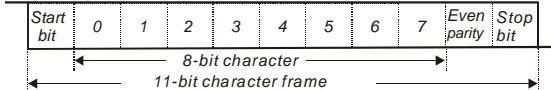

(8.O.1)

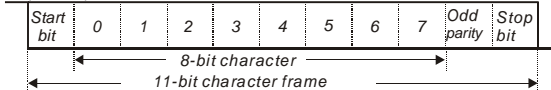

3. Communication Protocol

3.1 Communication Data Frame:

ASCII mode:

STX	Start character ':' (3AH)
Address Hi	Communication address:
Address Lo	8-bit address consists of 2 ASCII codes
Function Hi	Command code:
Function Lo	8-bit command consists of 2 ASCII codes
DATA (n-1) to DATA 0	Contents of data: Nx8-bit data consist of 2n ASCII codes n<=16, maximum of 32 ASCII codes
LRC CHK Hi	LRC check sum:
LRC CHK Lo	8-bit check sum consists of 2 ASCII codes
END Hi	End characters:
END Lo	END1= CR (0DH), END0= LF(0AH)

RTU mode:

START	A silent interval of more than 10 ms
Address	Communication address: 8-bit address
Function	Command code: 8-bit command
DATA (n-1) to DATA 0	Contents of data: n×8-bit data, n≤16
CRC CHK Low	CRC check sum: 16-bit check sum consists of 2 8-bit characters
CRC CHK High	
END	A silent interval of more than 10 ms

3.2 Address (Communication Address)

Valid communication addresses are in the range of 0 to 254. A communication address equal to 0, means broadcast to all AC drives (AMD). In this case, the AMD will not reply any message to the master device.

00H: broadcast to all AC drives

01H: AC drive of address 01

0FH: AC drive of address 15

10H: AC drive of address 16

⋮

FEH: AC drive of address 254

For example, communication to AMD with address 16 decimal (10H):

ASCII mode: Address='1','0' => '1'=31H, '0'=30H

RTU mode: Address=10H

3.3 Function (Function code) and DATA (data characters)

The format of data characters depends on the function code.

03H: read data from register

06H: write single register

08H: loop detection

10H: write multiple registers

The available function codes and examples for VFD-VL are described as follows:

(1) 03H: multi read, read data from registers.

Example: reading continuous 2 data from register address 2102H, AMD address is 01H.

ASCII mode:

Command message:

STX	':'
Address	'0'
	'1'
Function	'0'
	'3'
Starting data address	'2'
	'1'
	'0'
	'2'
Number of data (count by word)	'0'
	'0'

Response message:

STX	':'
Address	'0'
	'1'
Function	'0'
	'3'
Number of data (Count by byte)	'0'
	'4'
Content of starting address 2102H	'1'
	'7'
	'7'
	'0'

Command message:

	'0'
	'2'
	'D'
LRC Check	'7'
END	CR
	LF

Response message:

Content of address 2103H	'0'
	'0'
	'0'
LRC Check	'7'
END	'1'
	CR
	LF

RTU mode:

Command message:

Address	01H
Function	03H
Starting data address	21H
	02H
Number of data (count by word)	00H
	02H
CRC CHK Low	6FH
CRC CHK High	F7H

Response message:

Address	01H
Function	03H
Number of data (count by byte)	04H
Content of address 2102H	17H
	70H
Content of address 2103H	00H
	00H
CRC CHK Low	FEH
CRC CHK High	5CH

(2) 06H: single write, write single data to register.

Example: writing data 6000(1770H) to register 0100H. AMD address is 01H.

ASCII mode:

Command message:

STX	..
Address	'0'
	'1'
Function	'0'
	'6'
Data address	'0'
	'1'
	'0'
	'0'
Data content	'1'
	'7'
	'7'
	'0'
LRC Check	'7'
	'1'
END	CR
	LF

Response message:

STX	..
Address	'0'
	'1'
Function	'0'
	'6'
Data address	'0'
	'1'
	'0'
	'0'
Data content	'1'
	'7'
	'7'
	'0'
LRC Check	'7'
	'1'
END	CR
	LF

RTU mode:

Command message:

Address	01H
Function	06H
Data address	01H
	00H
Data content	17H
	70H

Response message:

Address	01H
Function	06H
Data address	01H
	00H
Data content	17H
	70H

CRC CHK Low	86H
CRC CHK High	22H

CRC CHK Low	86H
CRC CHK High	22H

(3) 10H: write multiple registers (write multiple data to registers)

Example: Set the multi-step speed,

Pr.04-00=50.00 (1388H), Pr.04-01=40.00 (0FA0H). AC drive address is 01H.

ASCII Mode:

Command message:	
STX	':'
Address 1	'0'
Address 0	'1'
Function 1	'1'
Function 0	'0'
Starting data address	'0'
	'5'
	'0'
	'0'
Number of data (count by word)	'0'
	'0'
	'2'
	'2'
Number of data (count by byte)	'0'
	'4'
The first data content	'1'
	'3'
	'8'
	'8'
The second data content	'0'
	'F'
	'A'
	'0'
LRC Check	'9'
	'A'
END	CR
	LF

Response message:	
STX	':'
Address 1	'0'
Address 0	'1'
Function 1	'1'
Function 0	'0'
Starting data address	'0'
	'5'
	'0'
	'0'
Number of data (count by word)	'0'
	'0'
	'2'
	'2'
LRC Check	'E'
	'8'
END	CR
	LF

RTU mode:

Command message:	
Address	01H
Function	10H
Starting data address	05H
	00H
Number of data (count by word)	00H'
	02H
Number of data (count by byte)	04
The first data content	13H
	88H
The second data content	0FH
	A0H
CRC Check Low	'9'
CRC Check High	'A'

Response message:	
Address	01H
Function	10H
Starting data address	05H
	00H
Number of data (count by word)	00H
	02H
CRC Check Low	41H
CRC Check High	04H

3.4 Check sum

ASCII mode:

LRC (Longitudinal Redundancy Check) is calculated by summing up, module 256, the values of the bytes from ADR1 to last data character then calculating the hexadecimal representation of the 2's-complement negation of the sum.

For example, reading 1 word from address 0401H of the AC drive with address 01H.

STX	':'
Address 1	'0'
Address 0	'1'
Function 1	'0'
Function 0	'3'
Starting data address	'0'
	'4'
	'0'
	'1'
Number of data	'0'
	'0'
	'0'
	'1'
LRC Check 1	'F'
LRC Check 0	'6'
END 1	CR
END 0	LF

$01H+03H+04H+01H+00H+01H=0AH$, the 2's-complement negation of 0AH is **F6H**.

RTU mode:

Address	01H
Function	03H
Starting data address	21H
	02H
Number of data (count by word)	00H
	02H
CRC CHK Low	6FH
CRC CHK High	F7H

CRC (Cyclical Redundancy Check) is calculated by the following steps:

Step 1: Load a 16-bit register (called CRC register) with FFFFH.

Step 2: Exclusive OR the first 8-bit byte of the command message with the low order byte of the 16-bit CRC register, putting the result in the CRC register.

Step 3: Examine the LSB of CRC register.

Step 4: If the LSB of CRC register is 0, shift the CRC register one bit to the right with MSB zero filling, then repeat step 3. If the LSB of CRC register is 1, shift the CRC register one bit to the right with MSB zero filling, Exclusive OR the CRC register with the polynomial value A001H, then repeat step 3.

Step 5: Repeat step 3 and 4 until eight shifts have been performed. When this is done, a complete 8-bit byte will have been processed.

Step 6: Repeat step 2 to 5 for the next 8-bit byte of the command message. Continue doing this until all bytes have been processed. The final contents of the CRC register are the CRC value. When transmitting the CRC value in the message, the upper and lower bytes of the CRC value must be swapped, i.e. the lower order byte will be transmitted first.

Chapter 4 Parameters | VFD-VL

The following is an example of CRC generation using C language. The function takes two arguments:

```
Unsigned char* data ← a pointer to the message buffer
Unsigned char length ← the quantity of bytes in the message buffer
The function returns the CRC value as a type of unsigned integer.
Unsigned int crc_chk(unsigned char* data, unsigned char length){
    int j;
    unsigned int reg_crc=0xFFFF;
    while(length--){
        reg_crc ^= *data++;
        for(j=0;j<8;j++){
            if(reg_crc & 0x01){ /* LSB(b0)=1 */
                reg_crc=(reg_crc>>1) ^ 0xA001;
            }else{
                reg_crc=reg_crc >>1;
            }
        }
    }
    return reg_crc;
}
```

3.5 Address list

The contents of available addresses are shown as below:

Content	Address	Function	
AC drive Parameters	GGnnH	GG means parameter group, nn means parameter number, for example, the address of Pr 4-01 is 0401H. Referencing to chapter 5 for the function of each parameter. When reading parameter by command code 03H, only one parameter can be read at one time.	
Command Write only	2000H	Bit 0-3	0: No function 1: Stop 2: Run 3: Jog + Run
		Bit 4-5	00B: No function 01B: FWD 10B: REV 11B: Change direction
		Bit 6-7	00B: 1st accel/decel 01B: 2nd accel/decel 10B: 3rd accel/decel 11B: 4th accel/decel
		Bit 8-11	Represented 16 step speeds.

Content	Address	Function	
Status monitor Read only		Bit 12	1: disable bit 06-11
		Bit 13~14	00B: No function
			01B: operated by digital keypad
			02B: operated by Pr.00-15 setting 03B: change operation source
		Bit 15	Reserved
	2001H	Frequency command	
	2002H	Bit 0	1: EF (external fault) on
		Bit 1	1: Reset
		Bit 2	1: B.B. ON
		Bit 3-15	Reserved
	2100H	Fault code: refer to Pr.06-16 to Pr.06-21	
	2119H	Bit 0-Bit 1	00: Stop
			01: deceleration
			10: Ready for operation
			11: operation
		Bit 2	1: JOG command
		Bit 3-Bit 4	00: FWD command, FWD output
			01: FWD command, REV output
			10: REV command, FWD output
			11: Reserved
		Bit 5	Reserved
		Bit 6	Reserved
		Bit 7	Reserved
		Bit 8	1: Master frequency Controlled by communication interface
		Bit 9	1: Master frequency controlled by analog/external terminals signal
		Bit 10	1: Operation command controlled by communication interface
	Bit 11	1: Parameters have been locked	
	Bit 12	1: enable to copy parameter from keypad	
	Bit 13-15	Reserved	
	2102H	Frequency command (F)	
	2103H	Output frequency (H)	
	2104H	Output current (AXXX.X)	
	2105H	DC-BUS Voltage (UXXX.X)	
	2106H	Output voltage (EXXX.X)	
	2107H	Current step number of Multi-Step Speed Operation	
	2116H	Multi-function display (Pr.00-04)	
	2120H	Frequency command when malfunction	
	2121H	Output frequency when malfunction	
	2122H	Output current when malfunction	
	2123H	Motor frequency when malfunction	
	2124H	Output voltage when malfunction	
	2125H	DC-bus voltage when malfunction	
2126H	Output power when malfunction		
2127H	Output torque when malfunction		
2128H	IGBT Temperature of Power Module at Present Fault		

Content	Address	Function
	2129H	Input status of multi-function terminal when malfunction (format is the same as Pr.00-04=16)
	212AH	Output status of multi-function terminal when malfunction (format is the same as Pr.00-04=17)
	212BH	Drive status when malfunction (format is the same as 2119H)
	2201H	Pr.00-05 user-defined setting
	2203H	AUI1 analog input (XXX.XX %)
	2204H	ACI analog input (XXX.XX %)
	2205H	AUI2 analog input (XXX.XX %)
	2206H	Display temperature of IGBT (°C)
	2207H	Display temperature of heatsink (°C) (only for model 40HP and above)
	2208H	Digital input state
	2209H	Digital output state

3.6 Exception response:

The AC motor drive is expected to return a normal response after receiving command messages from the master device. The following depicts the conditions when no normal response is replied to the master device.

The AC motor drive does not receive the messages due to a communication error; thus, the AC motor drive has no response. The master device will eventually process a timeout condition.

The AC motor drive receives the messages without a communication error, but cannot handle them. An exception response will be returned to the master device and an error message "CExx" will be displayed on the keypad of AC motor drive. The xx of "CExx" is a decimal code equal to the exception code that is described below.

In the exception response, the most significant bit of the original command code is set to 1, and an exception code which explains the condition that caused the exception is returned.

Example of an exception response of command code 06H and exception code 02H:

ASCII mode:

STX	':'
Address Low	'0'
Address High	'1'
Function Low	'8'
Function High	'6'
Exception code	'0'
	'2'
LRC CHK Low	'7'
LRC CHK High	'7'
END 1	CR
END 0	LF

RTU mode:

Address	01H
Function	86H
Exception code	02H
CRC CHK Low	C3H
CRC CHK High	A1H

The explanation of exception codes:

Exception code	Explanation
01	Illegal function code: The function code received in the command message is not available for the AC motor drive.
02	Illegal data address: The data address received in the command message is not available for the AC motor drive.

Exception code	Explanation
03	Illegal data value: The data value received in the command message is not available for the AC drive.
04	Slave device failure: The AC motor drive is unable to perform the requested action.
10	Communication time-out: If Pr.09-03 is not equal to 0.0, Pr.09-02=0~1, and there is no communication on the bus during the Time Out detection period (set by Pr.09-03), "cE10" will be shown on the keypad.

09-05 / Response Delay Time

Control mode	VF	VFPG	SVC	FOCPG	TQCPG	FOCPM

Factory Setting: 2.0

Settings 0.0 ~ 200.0 ms

 This parameter is the response delay time after AC drive receives communication command as shown in the following.

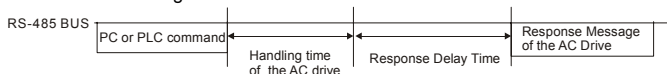

4.2.11 Group 10 Speed Feedback Control Parameters

10-00 PG Signal Type					Factory Setting: 0
Control mode	VFPG	FOCPG	TQCPG	FOCPM	
Settings	0	No function			
	1	ABZ			
	2	ABZ+ Hall			
	3	SIN/COS+Sinusoidal			
	4	SIN/COS+Endat			
	5	SIN/COS			
	6	SIN/COS + Hiperface			

 When Pr.10-00 is set to 3, encoder will have one sine and one cosine signal for each revolution. The signal must be: 0.75 to 1.2Vpp for the amplitude with phase angle $90^\circ \pm 5$ elec. (EX: ERN 1185 ERN 1387)

 When setting is 4 or 6, it needs to wait for 2 seconds after applying the power to execute RUN command.

 Detection of the magnetic pole:

Setting 1 or 5: The AC motor drive will output short circuit to detect the position of the magnetic pole. At this moment, the motor will generate a little noise.

Setting 2: The AC motor drive will detect the position of the magnetic pole by the UVW signal of encoder.

Setting 3: The AC motor drive will detect the position of the magnetic pole by the sine signal of encoder.

Setting 4 or 6: The AC motor drive will detect the position of the magnetic pole by the communication signal of encoder.

 Reference table for tuning

Setting of PG signal type	PG signal type	Applicable PG card	Pr.08-00=1	Pr.08-00=3
10-00=1	A, B, Z	EMVL-PGABO/ABL	Motor will run	Motor will run
10-00=2	A, B, Z+U, V, W	EMVL-PGABL	Motor will run	Motor will run
10-00=3	SIN/COS+Sinusoidal	EMVL-PGH01/02	Motor will run	Motor will run

Setting of PG signal type	PG signal type	Applicable PG card	Pr.08-00=1	Pr.08-00=3
10-00=4	SIN/COS+Endat	EMVL-PGS01	Motor will run	Motor won't run
10-00=5	SIN/COS	EMVL-PGH01/02	Motor will run	Motor will run
10-00=6	SIN/COS + Hiperface	EMVL-PGS01	Motor will run	Motor won't run

10-01 Encoder Pulse

Control mode **VFPG** **FOCPG** **TQCPG** **FOCPM**

Factory Setting: 600

Settings 1 to 20000

 A Pulse Generator (PG) or encoder is used as a sensor that provides a feedback signal of the motor speed. This parameter defines the number of pulses for each cycle of the PG control.

10-02 Encoder Input Type Setting

Control mode **VFPG** **FOCPG** **TQCPG** **FOCPM**

Factory Setting: 0

Settings 0 Disable

Phase A leads in a forward run command and phase B leads in a reverse run command

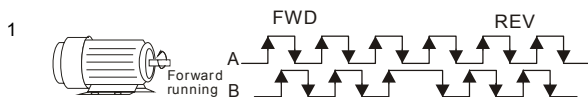

Phase B leads in a forward run command and phase A leads in a reverse run command

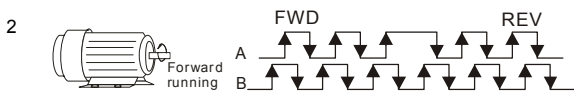

Phase A is a pulse input and phase B is a direction input. (low input=reverse direction, high input=forward direction)

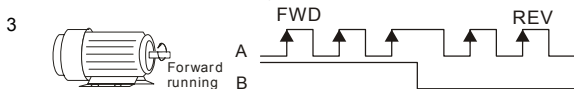

Phase A is a pulse input and phase B is a direction input. (low input=forward direction, high input=reverse direction)

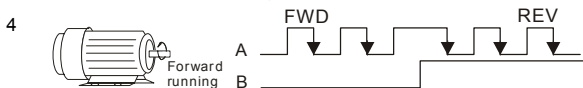



It is helpful for the stable control by inputting correct pulse type.

10-03 Encoder Feedback Fault Treatment (PGF1, PGF2)

Control mode	VFPG	FOCPG	TQCPG	Factory Setting: 2
Settings	0	Warn and keep operation		
	1	Warn and RAMP to stop		
	2	Warn and stop operation		

10-04 Detection Time for Encoder Feedback Fault

Control mode	VFPG	FOCPG	TQCPG	FOCPM	Factory Setting: 1.0
Settings		0.0 to 10.0 sec			

When PG loss, encoder signal error, pulse signal setting error or signal error, if time exceeds the detection time for encoder feedback fault (Pr.10-04), the PG signal error will occur. Refer to the Pr.10-03 for encoder feedback fault treatment.

10-05 Encoder Stall Level (PGF5)

Control mode	VFPG	SVC	FOCPG	FOCPM	Factory Setting: 115
Settings		0 to 120% (0: disable)			

This parameter determines the maximum encoder feedback signal allowed before a fault occurs. (max. output frequency Pr.01-00 =100%)

10-06 Encoder Stall Detection Time

Control mode	VFPG	SVC	FOCPG	FOCPM	Factory Setting: 0.1
Settings		0.0 to 2.0 sec			

10-07 Encoder Slip Range (PGF7)

Control mode	VFPG	SVC	FOCPG	FOCPM	Factory Setting: 50
Settings		0 to 50% (0: disable)			

10-08 ✓ Encoder Slip Detection Time

Control mode	VFPG	SVC	FOCPG	FOCPM	Factory Setting: 0.5
Settings			0.0 to 10.0 sec		

10-09 ✓ Encoder Stall and Slip Error Treatment

Control mode	VFPG	SVC	FOCPG	FOCPM	Factory Setting: 2
Settings		0		Warn and keep operating	
		1		Warn and RAMP to stop	
		2		Warn and COAST to stop	

When the value of (rotation speed – motor frequency) exceeds Pr.10-07 setting, detection time exceeds Pr.10-08 or motor frequency exceeds Pr.10-05 setting, it will start to accumulate time. If detection time exceeds Pr.10-06, the encoder feedback signal error will occur. Refer to Pr.10-09 encoder stall and slip error treatment.

10-10 Mode Selection for UVW Input

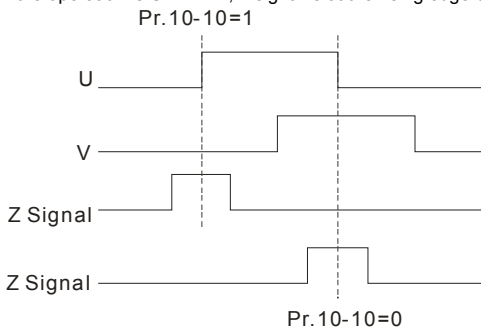

Control mode	VFPG	FOCPG	TQCPG	FOCPM	Factory Setting: 0
Settings		0		Z signal is at the falling edge of U-phase	
		1		Z signal is at the rising edge of U-phase	

Setting 0: when the operation is U->V->W, Z signal is at the falling edge of U-phase.
Setting 1: when the operation is U->V->W, Z signal is at the rising edge of U-phase.

**10-11** ✓ ASR (Auto Speed Regulation) Control (P) of Zero Speed

Control mode	VF	VFPG	SVC	FOCPG	FOCPM	Factory Setting: 100.0
--------------	----	------	-----	-------	-------	------------------------

Settings	0.0 to 500.0%					
10-12	↗ ASR (Auto Speed Regulation) Control (I) of Zero Speed					
Control mode	VF	VFP	SVC	FOCPG	FOCPM	Factory Setting: 0.100
Settings	0.000 to 10.000 sec					
10-13	↗ ASR (Auto Speed Regulation) control (P) 1					
Control mode	VF	VFP	SVC	FOCPG	FOCPM	Factory Setting: 100.0
Settings	0.0 to 500.0%					
10-14	↗ ASR (Auto Speed Regulation) control (I) 1					
Control mode	VF	VFP	SVC	FOCPG	FOCPM	Factory Setting: 0.100
Settings	0.000 to 10.000 sec					
10-15	↗ ASR (Auto Speed Regulation) control (P) 2					
Control mode	VF	VFP	SVC	FOCPG	FOCPM	Factory Setting: 100.0
Settings	0.0 to 500.0%					
10-16	↗ ASR (Auto Speed Regulation) control (I) 2					
Control mode	VF	VFP	SVC	FOCPG	FOCPM	Factory Setting: 0.100
Settings	0.000 to 10.000 sec					
10-17	↗ ASR 1/ASR2 Switch Frequency					
Control mode	VF	VFP	SVC	FOCPG	FOCPM	Factory Setting: 7.00
Settings	0.00 to 400.00Hz					
	0.00: disable					

-  ASR P determines Proportional control and associated gain (P). ASR I determines integral control and associated gain (I).
-  When integral time is set to 0, it is disabled. Pr.10-17 defines the switch frequency for the ASR1 (Pr.10-13, Pr.10-14) and ASR2 (Pr.10-15, Pr.10-16).

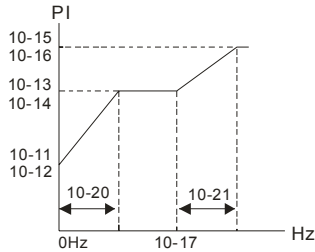

When using multi-function input terminals to switch ASR1/ASR2, the diagram will be shown as follows.

Setting multi-function input terminal to 17
(ASR1/ASR2 switch)

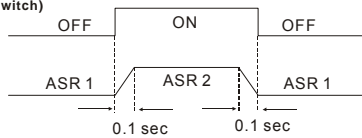

10-18 ASR Primary Low Pass Filter Gain

Control mode	VF	VFPG	SVC	FOCPG	FOCPM	Factory Setting: 0.008
Settings	0.000 to 0.350 sec					

It defines the filter time of the ASR command.

When setting to 1, this function is disabled.

10-19 Zero Speed Gain (P)

Control mode	FOCPM	Factory Setting: 80.00
Settings	0.00 to 655.00%	

When Pr.11-00 is set to Bit 7=1, Pr.10-19 is valid.

10-20 Zero Speed/ASR1 Width Adjustment

Control mode	VFPG	FOCPG	FOCPM	Factory Setting: 5.00
Settings	0.0 to 400.00Hz			

10-21 ASR1/ASR2 Width Adjustment

Control mode	VFPG	FOCPG	FOCPM	Factory Setting: 5.00
Settings	0.0 to 400.00Hz			

- These two parameters are used to decide width of slope of ASR command during zero speed to low speed or Pr.10-17 to high speed.

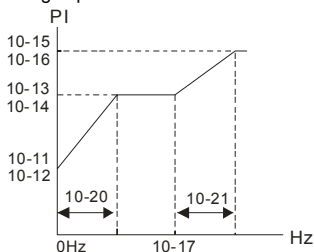

10-22 Zero Speed Position Holding Time

Control mode **FOCPM** Factory Setting: 0.250

Settings 0.001 to 65.535sec

10-23 Filter Time at Zero Speed

Control mode **FOCPM** Factory Setting: 0.004

Settings 0.001 to 65.535sec

10-24 Time for Executing Zero Speed

Control mode **FOCPM** Factory Setting: 0

Settings 0 After the brake release set in Pr.02-29

1 After the brake signal input (Pr.02-01~02-08 is set to 42)

- When Pr.10-24=0, the zero speed control needs to be used with Pr.02-29. (refer to the explanations in Pr.02-32)

10-25 Elevator Leveling (Zero Speed Gain P)

Control mode **VF** **VFPG** **SVC** **FOCPG** **FOCPM** Factory Setting: 0

Settings 0~1000.0%

10-26 Elevator Leveling (Zero Speed Integral I)

Control mode **VF** **VFPG** **SVC** **FOCPG** **FOCPM** Factory Setting: 0

Settings 0~10.000 sec

10-27 / Elevator Starting (Zero Speed Gain P)

Control mode	VF	VFPG	SVC	FOCPG	FOCPM	Factory Setting: 0
Settings			0~1000.0%			

10-28 / Elevator Starting (Zero Speed Integral I)

Control mode	VF	VFPG	SVC	FOCPG	FOCPM	Factory Setting: 0
Settings			0~10.000 sec			

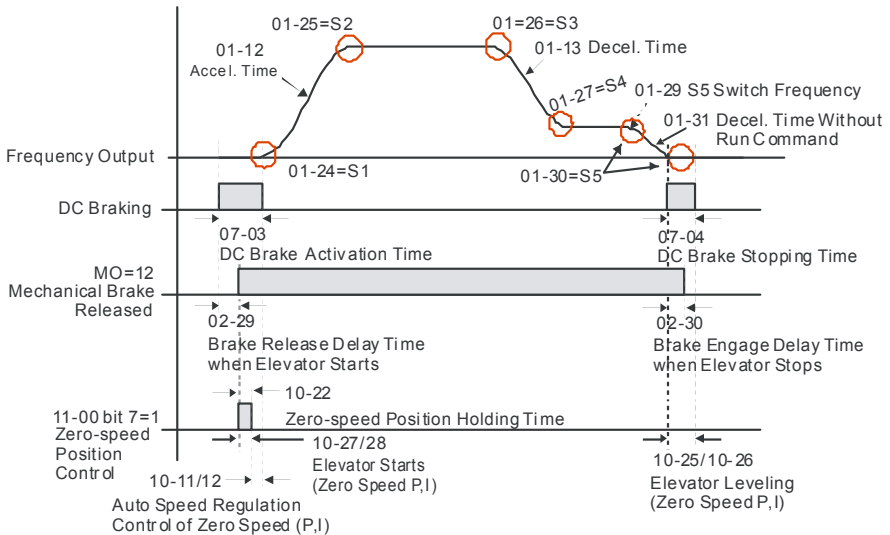

4.2.12 Group 11 Advanced Parameters

11-00 System Control			
Control mode	FOCPG	FOCPM	Factory Setting: 0
Settings	Bit 0=0	No function	
	Bit 0=1	ASR Auto tuning, PDFF enable	
	Bit 7=0	No function	
	Bit 7=1	When position control is enabled, it doesn't need to set Pr.07-02 (DC Brake Current Level)	
	Bit 15=0	when power is applied, it will detect the position of magnetic pole again	
	Bit 15=1	when power is applied, it will start from the magnetic pole position of previous power failure	

 Bit 0=1: PDFF function is enabled and system will generate an ASR setting, Pr. 10-11~10-16 will be invalid and Pr.11-09 to 11-10 will be valid.

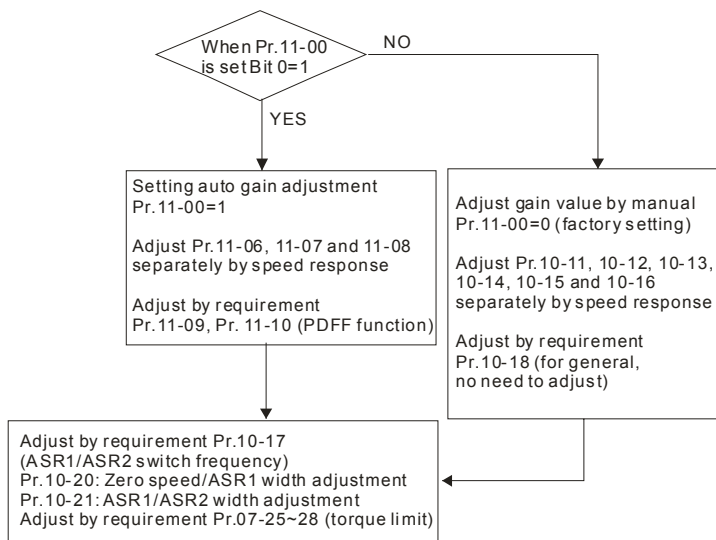

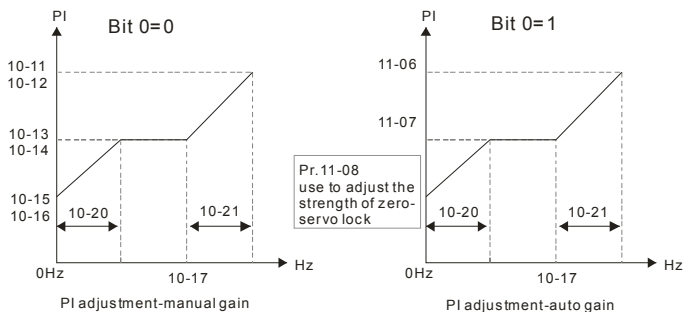
**11-01** ✓ Elevator SpeedControl mode FOC_{PG} FOC_{PM}

Factory Setting: 1.00

Settings 0.10 to 4.00 m/s

11-02 ✓ Sheave DiameterControl mode FOC_{PG} FOC_{PM}

Factory Setting: 400

Settings 100 to 2000 mm

11-03 ✓ Mechanical Gear RatioControl mode FOC_{PG} FOC_{PM}

Factory Setting: 1

Settings 1 to 100

11-04 ✓ Suspension RatioControl mode FOC_{PG} FOC_{PM}

Factory Setting: 1

Settings 0 1:1

1 2:1

suspension ratio 1:1

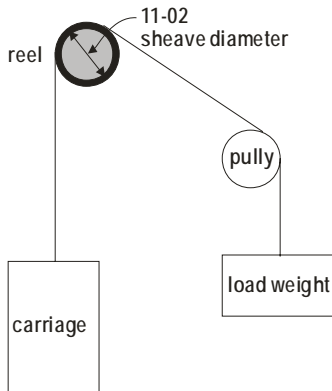

suspension ratio 2:1

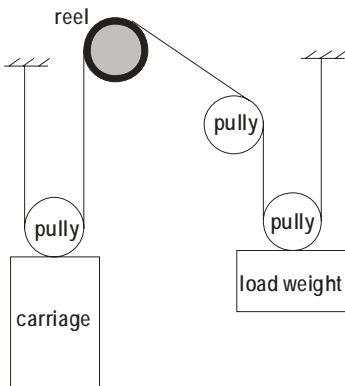

11-05 *↗* Inertial Ratio

Control mode **FOCPG FOCPM**

Factory Setting: 40

Settings 1 to 300%

The load inertia can be calculated by the settings of motor parameter, Pr.11-02 Sheave Diameter, Pr.11-14 Motor Current at Accel. and Pr.11-15 Elevator Acceleration. This parameter can be used to adjust inertia ratio of load.

11-06 *↗* Zero-speed Bandwidth

11-07 *↗* Low-speed Bandwidth

11-08 *↗* High-speed Bandwidth

Control mode **FOCPG FOCPM**

Factory Setting: 10

Settings 0 to 40Hz

After estimating inertia and set Pr.11-00=1 (auto tuning), user can adjust parameters Pr.11-06, 11-07 and 11-08 separately by speed response. The larger number you set, the faster response you will get. Pr.10-08 is the switch frequency for low-speed/high-speed bandwidth.

11-09 *↗* PDFF Gain Value

Control mode **FOCPG FOCPM**

Factory Setting: 30

Settings 0 to 200%

- After finishing estimating and set Pr.11-00=1 (auto tuning), using Pr.11-09/11-10 to reduce overshoot. Please adjust PDFF gain value by actual situation.
- Besides traditional PI control, it also provides PDFF function to reduce overshoot for speed control.
1. Get system inertia
 2. Set Pr.11-00 to 1
 3. Adjust Pr.11-09/11-10 (the larger number is set and the suppressed overshoot function will be better. But it needs to be used by the actual condition)

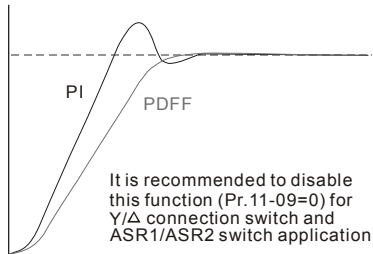

11-10 ✓ Gain for Speed Feed Forward

Control mode	FOCPG FOCPM	Factory Setting: 0
Settings	0 to 500	

- Pr.11-09 and Pr.11-10 will be enabled when Pr.11-00 is set to Bit0=1.

11-11 ✓ Notch Filter Depth

Control mode	FOCPG FOCPM	Factory Setting: 0
Settings	0 to 20 db	

11-12 ✓ Notch Filter Frequency

Control mode	FOCPG FOCPM	Factory Setting: 0.00
Settings	0.00 to 200.00Hz	

- This parameter is used to set resonance frequency of mechanical system. It can be used to suppress the resonance of mechanical system.
- The larger number you set Pr.11-11, the better suppression resonance function you will get.
- The notch filter frequency is the resonance of mechanical frequency.

11-13  Low-pass Filter Time of Keypad Display

Control mode	VF	VFP	SVC	FOCPG	TQCPG	FOCPM	Factory Setting: 0.500
--------------	----	-----	-----	-------	-------	-------	------------------------

Settings	0.001 to 65.535 s
----------	-------------------

 It is used to lower the blinking frequency of LCD display.

11-14  Motor Current at Accel.

Control mode	FOCPM	Factory Setting: 150
--------------	-------	----------------------

Settings	50 to 200%
----------	------------

11-15  Elevator Acceleration

Control mode	FOCPM	Factory Setting: 0.75
--------------	-------	-----------------------

Settings	0.20 to 2.00m/s ²
----------	------------------------------

4.2.13 Group 12 User-defined Parameters

12-00

12-31

User-defined Parameters

Control mode VF VFPG SVC FOC PG TQCPG FOC PM

Factory Setting: -

Settings -

- Users can enter the parameters from group 0 to group 11 into group 12 (it can save 32 parameters). The saved value can also be the parameter addresses (but the hexadecimal value needs to be converted to decimal value).
- Example 1: If you want to enter Pr.08-03 into Pr.12-00, you only need to enter 0803 into Pr.12-00. Then it will display the setting of Pr.08-03 in Pr.13-00. Refer to the following figure for the operation of KPVL-CC01.

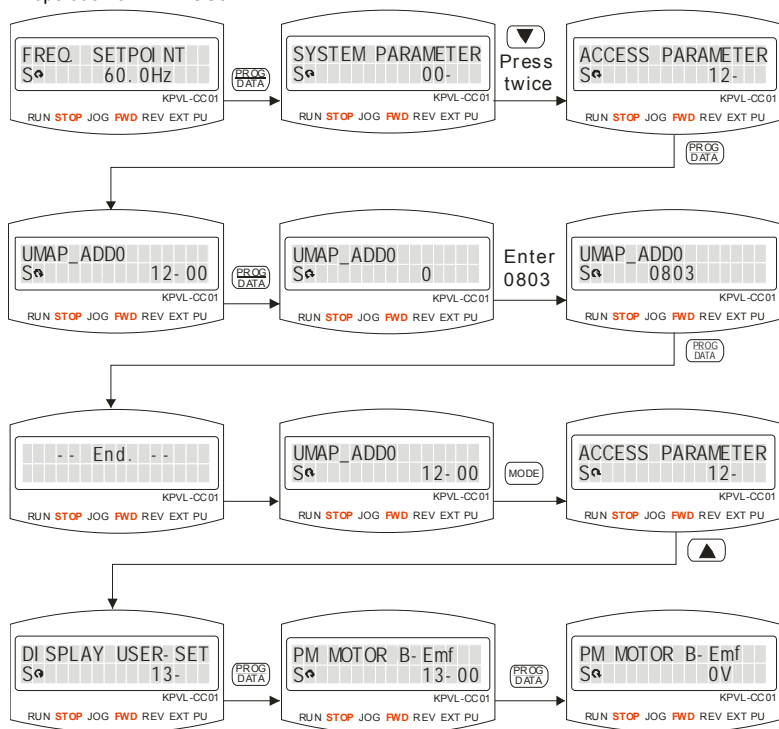

Example 2: If it needs to enter parameter address 2102H and 211BH by the digital keypad, 211BH needs to be converted to binary value before entering.

The setting method of 2102H

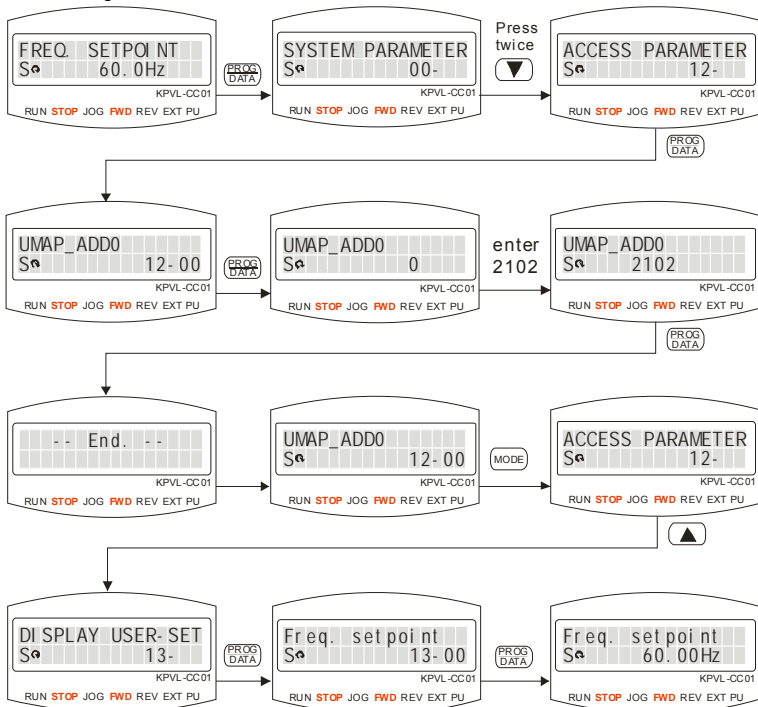

The setting method of 211BH

Convert 211BH (hexadecimal) to decimal value:

2 1 1 B

$$1 \times 16^1 + 11 \times 16^0 = 16 + 11 = 27 \quad \text{input 2127}$$

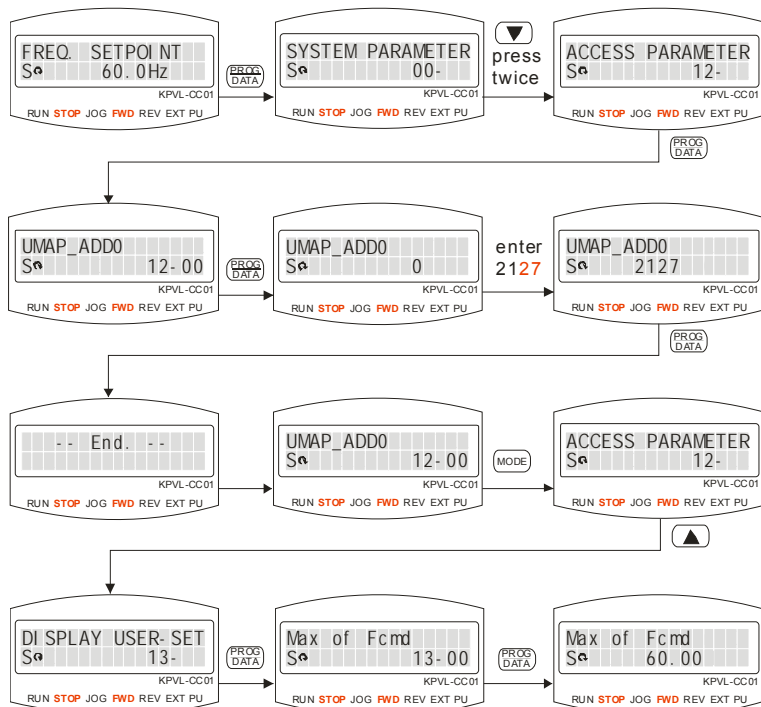

In the following, it shows the factory setting of Pr.12-00 to Pr.12-29. You can change the setting as required.

12-00 / Present Fault Record

Control mode	VF	VFP	SVC	FOCPG	TQCPG	FOCPM
--------------	----	-----	-----	-------	-------	-------

Settings	0610
----------	------

12-01 / Present Fault Time of Motor Operation (min.)

Control mode	VF	VFP	SVC	FOCPG	TQCPG	FOCPM
--------------	----	-----	-----	-------	-------	-------

Settings	0620
----------	------

12-02 / Present Fault Time of Motor Operation (day)

Control mode	VF	VFP	SVC	FOCPG	TQCPG	FOCPM
--------------	----	-----	-----	-------	-------	-------

Settings	0621
----------	------

12-03 / Frequency Command at Present Fault

Control mode	VF	VFP	SVC	FOCPG	TQCPG	FOCPM
--------------	----	-----	-----	-------	-------	-------

Settings	2120
----------	------

12-04 / Output Frequency at Preset Fault

Control mode	VF	VFP	SVC	FOCPG	TQCPG	FOCPM
--------------	----	-----	-----	-------	-------	-------

Settings	2121
----------	------

12-05 / Output Current at Present Fault

Control mode	VF	VFP	SVC	FOCPG	TQCPG	FOCPM
--------------	----	-----	-----	-------	-------	-------

Settings	2122
----------	------

12-06 / Motor Frequency at Present Fault

Control mode	VF	VFP	SVC	FOCPG	TQCPG	FOCPM
--------------	----	-----	-----	-------	-------	-------

Settings	2123
----------	------

12-07 / Output Voltage at Present Fault

Control mode	VF	VFP	SVC	FOCPG	TQCPG	FOCPM
--------------	----	-----	-----	-------	-------	-------

Settings 2124

12-08 / DC-Bus Voltage at Present Fault

Control mode	VF	VFP	SVC	FOCPG	TQCPG	FOCPM
--------------	----	-----	-----	-------	-------	-------

Settings 2125

12-09 / Output Power at Present Fault

Control mode	VF	VFP	SVC	FOCPG	TQCPG	FOCPM
--------------	----	-----	-----	-------	-------	-------

Settings 2126

12-10 / Output Torque at Present Fault

Control mode	VF	VFP	SVC	FOCPG	TQCPG	FOCPM
--------------	----	-----	-----	-------	-------	-------

Settings 2127

12-11 / IGBT Temperature of Power Module at Present Fault

Control mode	VF	VFP	SVC	FOCPG	TQCPG	FOCPM
--------------	----	-----	-----	-------	-------	-------

Settings 2128

12-12 / Multi-function Terminal Input Status at Present Fault

Control mode	VF	VFP	SVC	FOCPG	TQCPG	FOCPM
--------------	----	-----	-----	-------	-------	-------

Settings 2129

12-13 / Multi-function Terminal Output Status at Present Fault

Control mode	VF	VFP	SVC	FOCPG	TQCPG	FOCPM
--------------	----	-----	-----	-------	-------	-------

Settings 212A

12-14 / Drive Status at Present Fault

Control mode	VF	VFP	SVC	FOCPG	TQCPG	FOCPM
--------------	----	-----	-----	-------	-------	-------

Settings 212B

12-15 / Second Most Recent Fault Record

Control mode	VF	VFP	SVC	FOCPG	TQCPG	FOCPM
--------------	----	-----	-----	-------	-------	-------

Settings 0611

12-16 / Second Most Recent Fault Time of Motor Operation (min.)

Control mode	VF	VFP	SVC	FOCPG	TQCPG	FOCPM
--------------	----	-----	-----	-------	-------	-------

Settings 0622

12-17 / Second Most Recent Fault Time of Motor Operation (day)

Control mode	VF	VFP	SVC	FOCPG	TQCPG	FOCPM
--------------	----	-----	-----	-------	-------	-------

Settings 0623

12-18 / Third Most Recent Fault Record

Control mode	VF	VFP	SVC	FOCPG	TQCPG	FOCPM
--------------	----	-----	-----	-------	-------	-------

Settings 0612

12-19 / Third Most Recent Fault Time of Motor Operation (min.)

Control mode	VF	VFP	SVC	FOCPG	TQCPG	FOCPM
--------------	----	-----	-----	-------	-------	-------

Settings 0624

12-20 / Third Most Recent Fault Time of Motor Operation (day)

Control mode	VF	VFP	SVC	FOCPG	TQCPG	FOCPM
--------------	----	-----	-----	-------	-------	-------

Settings 0625

12-21 ✓ Fourth Most Recent Fault Record

Control mode	VF	VFPG	SVC	FOCPG	TQCPG	FOCPM
--------------	----	------	-----	-------	-------	-------

Settings	0613
----------	------

12-22 ✓ Fourth Most Recent Fault Time of Motor Operation (min.)

Control mode	VF	VFPG	SVC	FOCPG	TQCPG	FOCPM
--------------	----	------	-----	-------	-------	-------

Settings	0626
----------	------

12-23 ✓ Fourth Most Recent Fault Time of Motor Operation (day)

Control mode	VF	VFPG	SVC	FOCPG	TQCPG	FOCPM
--------------	----	------	-----	-------	-------	-------

Settings	0627
----------	------

12-24 ✓ Fifth Most Recent Fault Record

Control mode	VF	VFPG	SVC	FOCPG	TQCPG	FOCPM
--------------	----	------	-----	-------	-------	-------

Settings	0614
----------	------

12-25 ✓ Fifth Most Recent Fault Time of Motor Operation (min.)

Control mode	VF	VFPG	SVC	FOCPG	TQCPG	FOCPM
--------------	----	------	-----	-------	-------	-------

Settings	0628
----------	------

12-26 ✓ Fifth Most Recent Fault Time of Motor Operation (day)

Control mode	VF	VFPG	SVC	FOCPG	TQCPG	FOCPM
--------------	----	------	-----	-------	-------	-------

Settings	0629
----------	------

12-27 ✓ Sixth Most Recent Fault Record

Control mode	VF	VFPG	SVC	FOCPG	TQCPG	FOCPM
--------------	----	------	-----	-------	-------	-------

Settings	0615
----------	------

12-28 ⚡ Sixth Most Recent Fault Time of Motor Operation (min.)

Control mode	VF	VFP	SVC	FOCPG	TQCPG	FOCPM
--------------	----	-----	-----	-------	-------	-------

Settings 062A

12-29 ⚡ Sixth Most Recent Fault Time of Motor Operation (day)

Control mode	VF	VFP	SVC	FOCPG	TQCPG	FOCPM
--------------	----	-----	-----	-------	-------	-------

Settings 062B

4.2.14 Group 13 View User-defined Parameters

13-00

|

13-31

View User-defined Parameters

Control mode	VF	VFPG	SVC	FOCPG	TQCPG	FOCPM	Factory Setting: -
Settings							-

 Refer to group 12 for details.

Chapter 5 Troubleshooting

5.1 Over Current (OC)

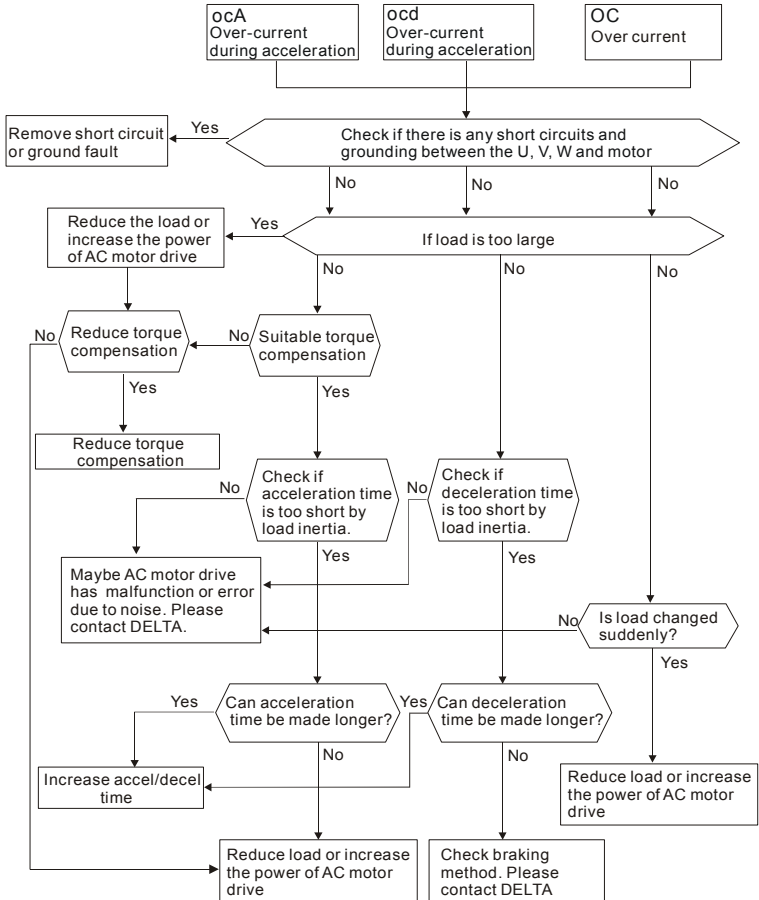

5.2 Ground Fault

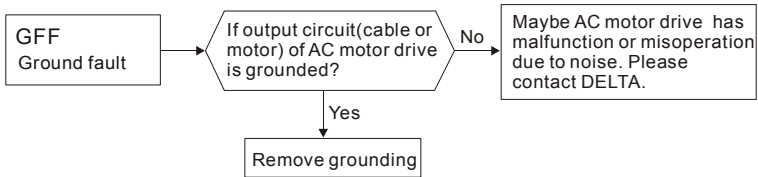

5.3 Over Voltage (OV)

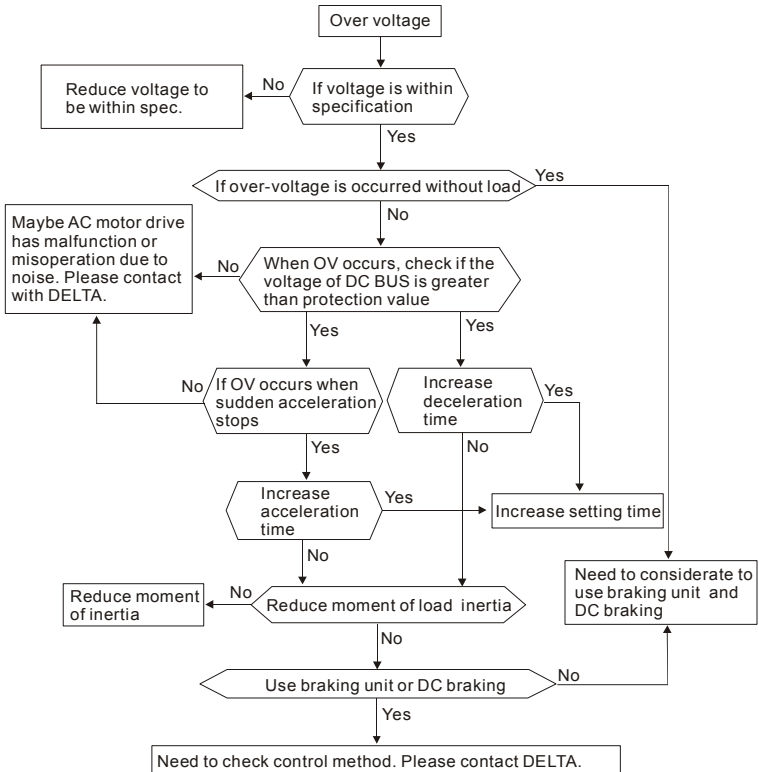

5.4 Low Voltage (Lv)

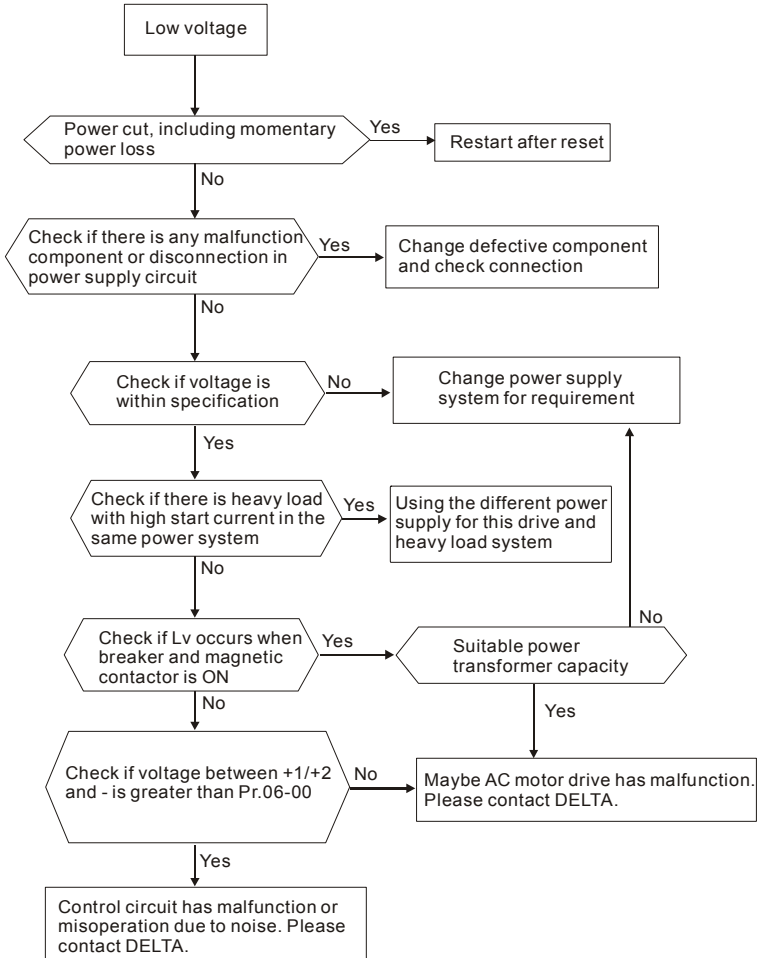

5.5 Over Heat (OH)

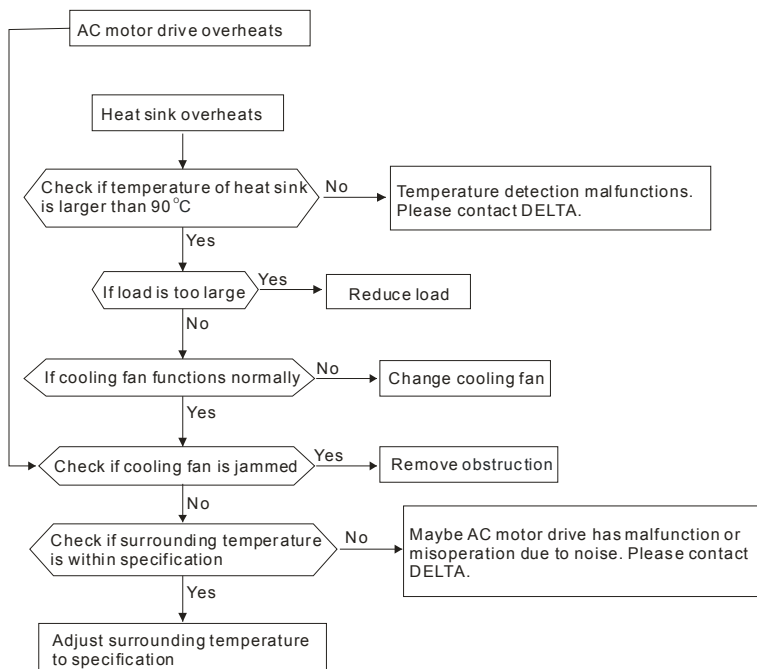

5.6 Overload

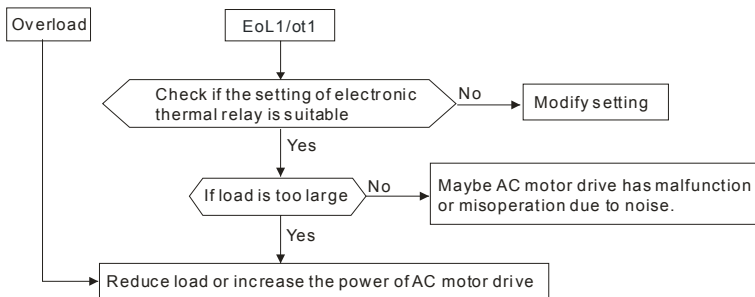

5.7 Display of KPVL-CC01 is Abnormal

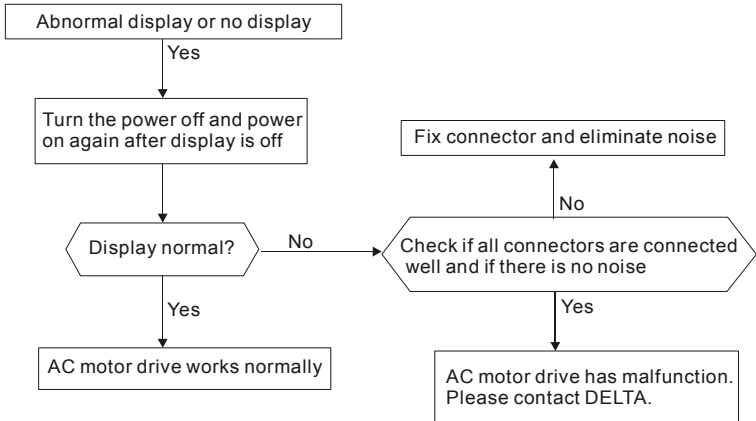

5.8 Phase Loss (PHL)

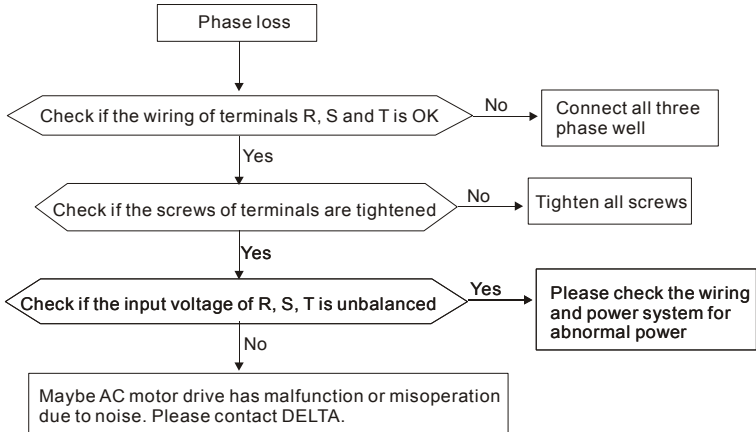

5.9 Motor cannot Run

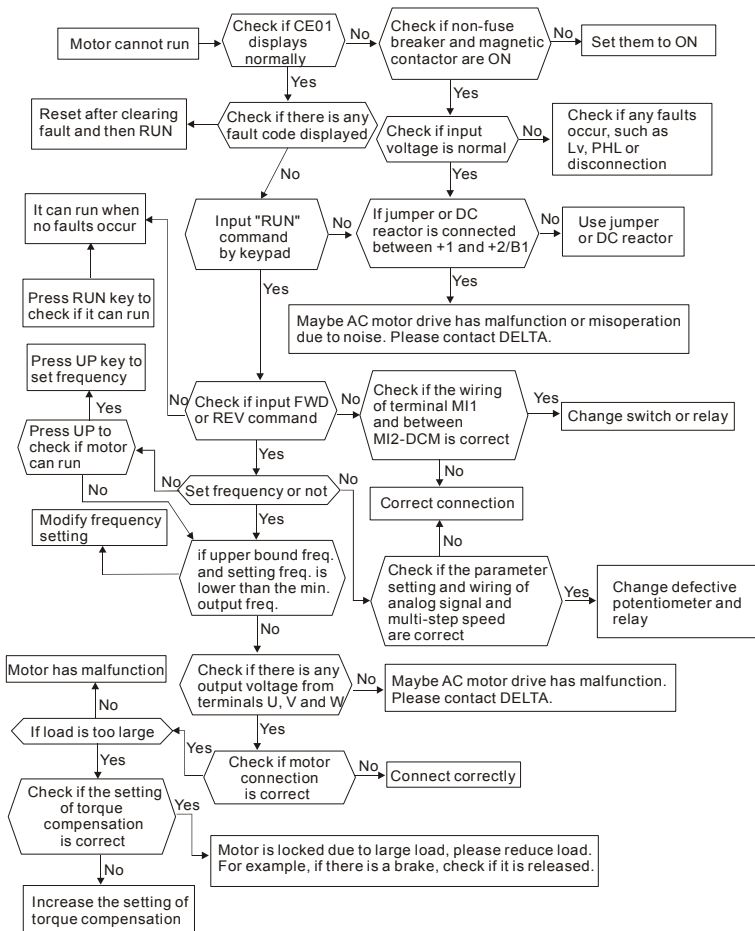

5.10 Motor Speed cannot be Changed

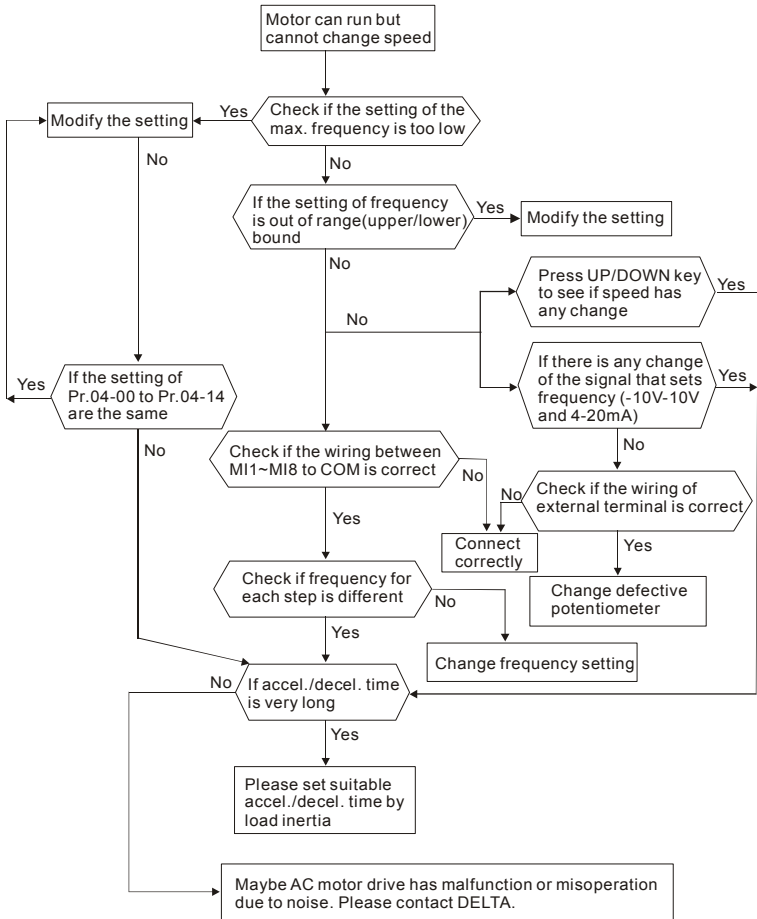

5.11 Motor Stalls during Acceleration

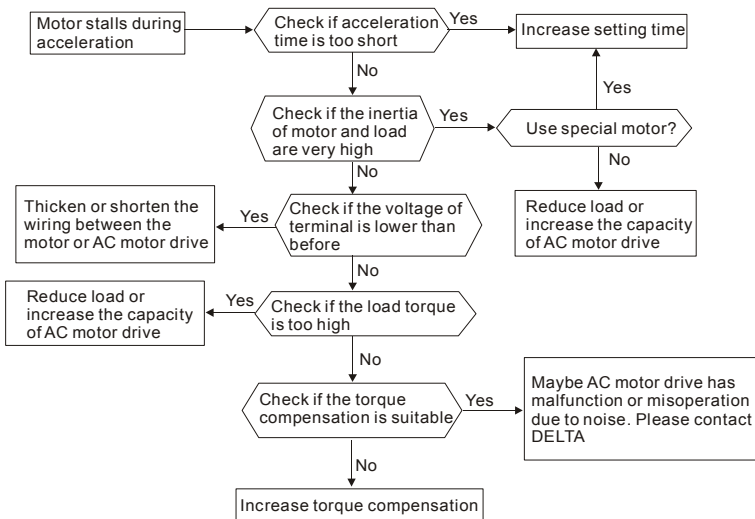

5.12 The Motor does not Run as Expected

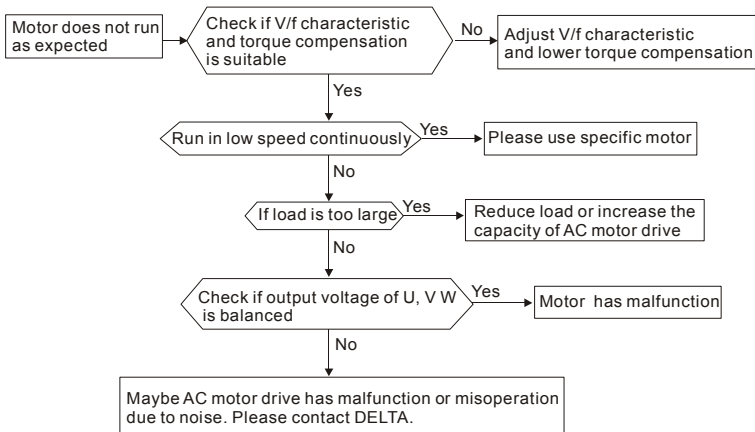

5.13 Electromagnetic/Induction Noise

There are many noises surround the AC motor drives and invade it by radiation or power circuit. It may cause the misoperation of control circuit and even damage the AC motor drive. Of course, that is a solution to increase the noise tolerance of AC motor drive. But it is not the best one due to the limit. Therefore, solve it from the outside as following will be the best.

1. Add surge killer on the relay or contact to suppress switching surge between ON/OFF.
2. Shorten the wiring length of the control circuit or serial circuit and separate from the main circuit wiring.
3. Comply with the wiring regulation for those shielded wire and use isolation amplifier for long wire.
4. The grounding terminal should comply with the local regulation and ground independently, i.e. not to have common ground with electric welding machine and power equipment.
5. Connect a noise filter at the input terminal of the AC motor drive to prevent noise from power circuit.

In a word, three-level solutions for electromagnetic noise are “no product”, “no spread” and “no receive”.

5.14 Environmental Condition

Since AC motor drive is an electronic device, you should comply with the environmental condition stated in the appendix A. Following are the remedial measures for necessary.

1. To prevent vibration, anti-vibration spacer is the last choice. The vibration tolerance must be within the specification. The vibration effect is equal to the mechanical stress and it cannot occur frequently, continuously or repeatedly to prevent damaging AC motor drive.
2. Store in a clean and dry location free from corrosive fumes/dust to prevent rustiness, poor contact. It also may cause short by low insulation in a humid location. The solution is to use both paint and dust-proof. For particular occasion, use the enclosure with whole-seal structure.
3. The surrounding temperature should be within the specification. Too high or low temperature will affect the lifetime and reliability. For semiconductor components, damage will occur once any specification is out of range. Therefore, it is necessary to clean and periodical check for the air cleaner and cooling fan besides having cooler and sunshade.

In additional, the microcomputer may not work in extreme low temperature and needs to have heater.

4. Store within a relative humidity range of 0% to 90% and non-condensing environment. Do not turn off the air conditioner and have exsiccator for it.

5.15 Affecting Other Machines

AC motor drive may affect the operation of other machine due to many reasons. The solutions are as follows.

■ High Harmonic at Power Side

If there is high harmonic at power side during running, the improved methods are:

1. Separate power system: use transformer for AC motor drive.
2. Use reactor at the power input terminal of AC motor drive or decrease high harmonic by multiple circuit.
3. If there is phase lead capacitor, it should use serial reactor to prevent capacitor damage from high harmonic.

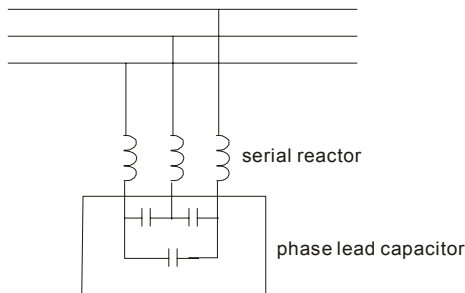

■ Motor Temperature Rises

When the motor is induction motor with ventilation-cooling-type used in variety speed operation, bad cooling will happen in the low speed. Therefore, it may overheat. Besides, high harmonic is in output waveform to increase copper loss and iron loss. Following measures should be used by load situation and operation range when necessary.

1. Use the motor with independent power ventilation or increase the horsepower.
2. Use inverter duty motor.
3. Do NOT run in the low speed

Chapter 6 Fault Code Information

6.1 Fault Code Information

The AC motor drive has a comprehensive fault diagnostic system that includes several different alarms and fault messages. Once a fault is detected, the corresponding protective functions will be activated. The following faults are displayed as shown on the AC motor drive digital keypad display. The six most recent faults can be read from the digital keypad or communication.

The AC motor drive is made up by numerous components, such as electronic components, including IC, resistor, capacity, transistor, and cooling fan, relay, etc. These components can't be used permanently. They have limited-life even under normal operation. Preventive maintenance is required to operate this AC motor drive in its optimal condition, and to ensure a long life.

Basic check-up items to detect if there were any abnormalities during operation are:



- Wait 5 seconds after a fault has been cleared before performing reset via keypad of input terminal.
- When the power is off after 5 minutes for $\leq 22\text{kW}$ models and 10 minutes for $\geq 30\text{kW}$ models, please confirm that the capacitors have fully discharged by measuring the voltage between DC+ and DC-. The voltage between DC+ and DC- should be less than 25VDC.
- Only qualified personnel can install, wire and maintain AC motor drives. Please take off any metal objects, such as watches and rings, before operation. And only insulated tools are allowed.
- Never reassemble internal components or wiring.
- Make sure that installation environment comply with regulations without abnormal noise, vibration and smell.

6.1.1 Common Problems and Solutions

Following fault name will only be displayed when using with optional digital keypad KPVL-CC01.

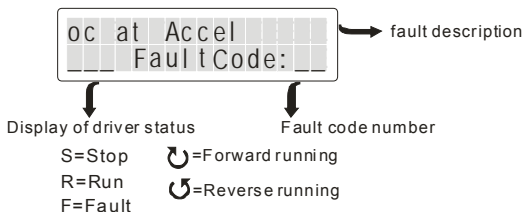







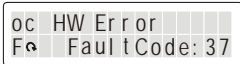

Display	Description
	<p>Over-current during acceleration (Output current exceeds triple rated current during acceleration.)</p> <p>Corrective Actions:</p> <ol style="list-style-type: none"> Short-circuit at motor output: Check for possible poor insulation at the output lines. Acceleration Time too short: Increase the Acceleration Time. AC motor drive output power is too small: Replace the AC motor drive with the next higher power model.
	<p>Over-current during deceleration (Output current exceeds triple rated current during deceleration.)</p> <p>Corrective Actions:</p> <ol style="list-style-type: none"> Short-circuit at motor output: Check for possible poor insulation at the output line. Deceleration Time too short: Increase the Deceleration Time. AC motor drive output power is too small: Replace the AC motor drive with the next higher power model.
	<p>Over-current during steady state operation (Output current exceeds triple rated current during constant speed.)</p> <p>Corrective Actions:</p> <ol style="list-style-type: none"> Short-circuit at motor output: Check for possible poor insulation at the output line. Sudden increase in motor loading: Check for possible motor stall. AC motor drive output power is too small: Replace the AC motor drive with the next higher power model.

Display	Description
<div style="border: 1px solid black; padding: 5px; width: fit-content;"> Ground Fault Fα Fault Code: 04 </div>	<p>Ground fault</p> <p>Corrective Actions: When (one of) the output terminal(s) is grounded, short circuit current is more than 75% of AC motor drive rated current, the AC motor drive power module may be damaged. NOTE: The short circuit protection is provided for AC motor drive protection, not for protection of the user.</p> <ol style="list-style-type: none"> 1. Check the wiring connections between the AC motor drive and motor for possible short circuits, also to ground. 2. Check whether the IGBT power module is damaged. 3. Check for possible poor insulation at the output line.
<div style="border: 1px solid black; padding: 5px; width: fit-content;"> Short Fault Fα Fault Code: 05 </div>	<p>Short-circuit is detected between upper bridge and lower bridge of the IGBT module.</p> <p>Corrective Actions: Return to the factory</p>
<div style="border: 1px solid black; padding: 5px; width: fit-content;"> oc at Stop Fα Fault Code: 06 </div>	<p>Over-current at stop</p> <p>Corrective Actions: Return to the factory</p>
<div style="border: 1px solid black; padding: 5px; width: fit-content;"> ov at Accel Fα Fault Code: 07 </div>	<p>DC BUS over-voltage during acceleration (230V: DC 450V; 460V: DC 900V)</p> <p>Corrective Actions:</p> <ol style="list-style-type: none"> 1. Check if the input voltage falls within the rated AC motor drive input voltage range. 2. Check for possible voltage transients. 3. If DC BUS over-voltage due to regenerative voltage, please increase the Deceleration Time or add an optional brake resistor.
<div style="border: 1px solid black; padding: 5px; width: fit-content;"> ov at Decel Fα Fault Code: 08 </div>	<p>DC BUS over-voltage during deceleration (230V: DC 450V; 460V: DC 900V)</p> <p>Corrective Actions:</p> <ol style="list-style-type: none"> 1. Check if the input voltage falls within the rated AC motor drive input voltage range. 2. Check for possible voltage transients. 3. If DC BUS over-voltage due to regenerative voltage, please increase the Deceleration Time or add an optional brake resistor.
<div style="border: 1px solid black; padding: 5px; width: fit-content;"> ov at Normal SPD Fα Fault Code: 09 </div>	<p>DC BUS over-voltage during constant speed (230V: DC 450V; 460V: DC 900V)</p> <p>Corrective Actions:</p> <ol style="list-style-type: none"> 1. Check if the input voltage falls within the rated AC motor drive input voltage range. 2. Check for possible voltage transients. 3. If DC BUS over-voltage due to regenerative voltage, please increase the Deceleration Time or add an optional brake resistor.





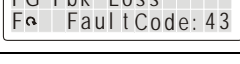



Display	Description
<div style="border: 1px solid black; padding: 5px; width: fit-content;"> ov at Stop F_a Fault Code: 10 </div>	DC BUS over-voltage at stop Corrective Actions: <ol style="list-style-type: none"> 1. Check if the input voltage falls within the rated AC motor drive input voltage range. 2. Check for possible voltage transients.
<div style="border: 1px solid black; padding: 5px; width: fit-content;"> Lv at Accel F_a Fault Code: 11 </div>	DC BUS voltage is less than Pr.06-00 during acceleration. Corrective Actions: <ol style="list-style-type: none"> 1. Check if the input voltage is normal 2. Check for possible sudden load
<div style="border: 1px solid black; padding: 5px; width: fit-content;"> Lv at Decel F_a Fault Code: 12 </div>	DC BUS voltage is less than Pr.06-00 during deceleration. Corrective Actions: <ol style="list-style-type: none"> 1. Check if the input voltage is normal 2. Check for possible sudden load
<div style="border: 1px solid black; padding: 5px; width: fit-content;"> Lv at Normal SPD F_a Fault Code: 13 </div>	DC BUS voltage is less than Pr.06-00 during constant speed. Corrective Actions: <ol style="list-style-type: none"> 1. Check if the input voltage is normal 2. Check for possible sudden load
<div style="border: 1px solid black; padding: 5px; width: fit-content;"> Lv at Stop F_a Fault Code: 14 </div>	Low voltage at stop Corrective Actions: <ol style="list-style-type: none"> 1. Check if the input voltage is normal 2. Check for possible sudden load
<div style="border: 1px solid black; padding: 5px; width: fit-content;"> Phase Loss F_a Fault Code: 15 </div>	Phase loss Corrective Actions: Check Power Source Input if all 3 input phases are connected without loose contacts.
<div style="border: 1px solid black; padding: 5px; width: fit-content;"> IGBT Over Heat F_a Fault Code: 16 </div>	IGBT overheating IGBT temperature exceeds protection level 1 to 15HP: 90 °C 20 to 100HP: 100 °C Corrective Actions: <ol style="list-style-type: none"> 1. Ensure that the ambient temperature falls within the specified temperature range. 2. Make sure that the ventilation holes are not obstructed. 3. Remove any foreign objects from the heatsinks and check for possible dirty heat sink fins. 4. Check the fan and clean it. 5. Provide enough spacing for adequate ventilation.

Display	Description
Heat Sink oH Fa Fault Code: 17	<p>IGBT overheating IGBT temperature exceeds protection level 40 to 100HP: 100 °C</p> <p>Corrective Actions:</p> <ol style="list-style-type: none"> 1. Ensure that the ambient temperature falls within the specified temperature range. 2. Make sure that the ventilation holes are not obstructed. 3. Remove any foreign objects from the heatsinks and check for possible dirty heat sink fins. 4. Check the fan and clean it. 5. Provide enough spacing for adequate ventilation.
IGBT HW Err Fa Fault Code: 18	<p>IGBT hardware failure</p> <p>Corrective Actions: Return to the factory</p>
Heat Sink HW Err Fa Fault Code: 19	<p>Heatsink overheating</p> <p>Corrective Actions: Return to the factory</p>
Fan Locked Fa Fault Code: 20	<p>Fan failure</p> <p>Corrective Actions:</p> <ol style="list-style-type: none"> 1. Make sure that the fan is not obstructed. 2. Return to the factory
Inverter oL Fa Fault Code: 21	<p>Overload The AC motor drive detects excessive drive output current. NOTE: The AC motor drive can withstand up to 150% of the rated current for a maximum of 60 seconds.</p> <p>Corrective Actions:</p> <ol style="list-style-type: none"> 1. Check whether the motor is overloaded. 2. Take the next higher power AC motor drive model.
Thermal Relay 1 Fa Fault Code: 22	<p>Motor 1 overload</p> <p>Corrective Actions:</p> <ol style="list-style-type: none"> 1. Check whether the motor is overloaded. 2. Check whether the rated current of motor (Pr.05-01) is suitable 3. Take the next higher power AC motor drive model.
Motor Over Heat Fa Fault Code: 24	<p>Motor overheating The AC motor drive detects that the internal temperature exceeds Pr.06-30 (PTC level)</p> <p>Corrective Actions:</p> <ol style="list-style-type: none"> 1. Make sure that the motor is not obstructed. 2. Ensure that the ambient temperature falls within the specified temperature range. 3. Take the next higher power AC motor drive model.

Display	Description
Over Torque 1 F _a Fault Code: 26	Electronic Thermal Relay 1 Protection Corrective Actions: <ol style="list-style-type: none"> 1. Check whether the motor is overloaded. 2. Check whether motor rated current setting (Pr.05-01) is suitable 3. Check electronic thermal relay function 4. Take the next higher power AC motor drive model.
Over Torque 2 F _a Fault Code: 27	Electronic Thermal Relay 2 Protection Corrective Actions: <ol style="list-style-type: none"> 1. Check whether the motor is overloaded. 2. Check whether motor rated current setting (Pr.05-01) is suitable 3. Check electronic thermal relay function 4. Take the next higher power AC motor drive model.
EEPROM Write Err F _a Fault Code: 30	Internal EEPROM can not be programmed. Corrective Actions: <ol style="list-style-type: none"> 1. Press "RESET" key to the factory setting. 2. Return to the factory.
EEPROM Read Err F _a Fault Code: 31	Internal EEPROM can not be read. Corrective Actions: <ol style="list-style-type: none"> 1. Press "RESET" key to the factory setting. 2. Return to the factory.
I sum Sensor Err F _a Fault Code: 32	Hardware failure in current detection Corrective Actions: Re-power on to try it. If fault code is still displayed on the keypad, please return to the factory.
I as Sensor Err F _a Fault Code: 33	U-phase error Corrective Actions: Re-power on to try it. If fault code is still displayed on the keypad, please return to the factory.
I bs Sensor Err F _a Fault Code: 34	V-phase error Corrective Actions: Re-power on to try it. If fault code is still displayed on the keypad, please return to the factory.
I cs Sensor Err F _a Fault Code: 35	W-phase error Corrective Actions: Re-power on to try it. If fault code is still displayed on the keypad, please return to the factory.
cc HW Error F _a Fault Code: 36	CC (current clamp) Corrective Actions: Re-power on to try it. If fault code is still displayed on the keypad, please return to the factory.

Display	Description
	OC hardware error Corrective Actions: Re-power on to try it. If fault code is still displayed on the keypad, please return to the factory.
	OV hardware error Corrective Actions: Re-power on to try it. If fault code is still displayed on the keypad, please return to the factory.
	GFF hardware error Corrective Actions: Re-power on to try it. If fault code is still displayed on the keypad, please return to the factory.
	Auto tuning error Corrective Actions: <ol style="list-style-type: none"> 1. Check cabling between drive and motor 2. Check the motor capacity and parameters settings 3. Retry again
	PID loss (ACI) Corrective Actions: <ol style="list-style-type: none"> 1. Check the wiring of the PID feedback 2. Check the PID parameters settings
	PG feedback error Corrective Actions: Check if Pr.10-01 is not set to 0 when it is PG feedback control
	PG feedback loss Corrective Actions: Check the wiring of the PG feedback
	PG feedback stall Corrective Actions: <ol style="list-style-type: none"> 1. Check the wiring of the PG feedback 2. Check if the setting of PI gain and deceleration is suitable 3. Return to the factory
	PG slip error Corrective Actions: <ol style="list-style-type: none"> 1. Check the wiring of the PG feedback 2. Check if the setting of PI gain and deceleration is suitable 3. Return to the factory

Display	Description
PG Ref Error F _a Fault Code: 46	Pulse input error Corrective Actions: 1. Check the pulse wiring 2. Return to the factory
PG Ref Loss F _a Fault Code: 47	Pulse input loss Corrective Actions: 1. Check the pulse wiring 2. Return to the factory
ACI Loss F _a Fault Code: 48	ACI loss Corrective Actions: 1. Check the ACI wiring 2. Check if the ACI signal is less than 4mA
External Fault F _a Fault Code: 49	External Fault Corrective Actions: 1. Input EF (N.O.) on external terminal is closed to GND. Output U, V, W will be turned off. 2. Give RESET command after fault has been cleared.
Emergency Stop F _a Fault Code: 50	Emergency stop Corrective Actions: 1. When the multi-function input terminals MI1 to MI8 are set to emergency stop and the AC motor drive stops output. 2. Press RESET after fault has been cleared.
Base Block F _a Fault Code: 51	Base Block Corrective Actions: 1. When the multi-function input terminals MI1 to MI8 are set to base block and the AC motor drive stops output. 2. Press RESET after fault has been cleared.
Password Error F _a Fault Code: 52	Password is locked Corrective Actions: Keypad will be locked. Turn the power ON after power OFF to re-enter the correct password. See Pr.00-07 and 00-08.
PC Err Command F _a Fault Code: 54	Illegal function code Corrective Actions: Check if the function code is correct (function code must be 03, 06, 10, 63)
PC Err Address F _a Fault Code: 55	Illegal data length Corrective Actions: Check if the communication data length is correct.
PC Err Data F _a Fault Code: 56	Illegal data value Corrective Actions: Check if the data value exceeds max./min. value.

Display	Description
	illegal communication address Corrective Actions: Check if the communication address is correct.
	Communication time-out Corrective Actions: Check if the wiring for the communication is correct.
	Keypad (KPVL-CC01) communication time-out Corrective Actions: 1. Check if the wiring for the communication is correct 2. Check if there is any wrong with the keypad
	Brake chopper fail Corrective Actions: Press RESET key to correct it. If fault code is still displayed on the keypad, please return to the factory.
	Safety loop error Corrective Actions: 1. Check if the jumper JP18 is short circuit. 2. Re-power on to try it. If fault code is still displayed on the keypad, please return to the factory.
	Mechanical brake error Corrective Actions: 1. Check if the mechanical brake signal is correct. 2. Check if the detection time setting of mechanical brake (Pr.02-35) is correct.
	PG hardware error Corrective Actions: 1. Check if the wiring of PG feedback is correct. 2. If fault code is still displayed on the keypad with correct PG feedback, please return to the factory.
	Electromagnetic valve error Corrective Actions: 1. Check if the signal of electromagnetic valve is correct. 2. Check if the setting of Pr.02-36 is correct.

6.1.2 Reset

There are three methods to reset the AC motor drive after solving the fault:

- Press  key on KPVL-CC01.

2. Set external terminal to "RESET" and then set to be ON.
3. Send "RESET" command by communication.



Make sure that RUN command or signal is OFF before executing RESET to prevent damage or personal injury due to immediate operation.

Appendix A Specifications

There are 230V and 460V models for customers to choose by their requirement.

Voltage Class		230V Class							
Model Number VFD-XXXVL		055	075	110	150	185	220	300	370
Max. Applicable Motor Output (kW)		5.5	7.5	11	15	18.5	22	30	37
Max. Applicable Motor Output (hp)		7.5	10	15	20	25	30	40	50
Output Rating	Rated Output Capacity (kVA)	9.5	12.5	19	25	29	34	46	55
	Rated Output Current for General Purposes (A)	21.9	27.1	41.1	53	70	79	120	146
	**Rated Output Current for Elevators (A)	25	31	47	60	80	90	150	183
	Maximum Output Voltage (V)	3-Phase Proportional to Input Voltage							
	Output Frequency (Hz)	0.00~120.00 Hz							
	Carrier Frequency (kHz)	12kHz			9kHz			6kHz	
Input Rating	Rated Input Current (A)	25	31	47	60	80	90	106	126
	Rated Voltage/Frequency	3-phase 200-240V, 50/60Hz							
	Voltage Tolerance	±10%(180~264 V)							
	Frequency Tolerance	±5%(47~63 Hz)							
	Cooling Method	Fan Cooled							
Weight (kg)		8	10	10	13	13	13	36	36

Voltage Class		460V Class										
Model Number VFD-XXXVL		055	075	110	150	185	220	300	370	450	550	750
Max. Applicable Motor Output (kW)		5.5	7.5	11	15	18.5	22	30	37	45	55	75
Max. Applicable Motor Output (hp)		7.5	10	15	20	25	30	40	50	60	75	100
Output Rating	Rated Output Capacity (kVA)	9.9	13.7	18	24	29	34	46	56	69	80	100
	Rated Output Current for General Purposes (A)	12.3	15.8	21	27	34	41	60	73	91	110	150
	**Rated Output Current for Elevators (A)	14	18	24	31	39	47	75	91	113	138	188
	Maximum Output Voltage (V)	3-phase Proportional to Input Voltage										
	Output Frequency (Hz)	0.00~120.00 Hz										
	Carrier Frequency (kHz)	15kHz			9kHz			6kHz				
Input Rating	Rated Input Current (A)	14	18	24	31	39	47	56	67	87	101	122
	Rated Voltage	3-phase 380 to 480 V, 50/60Hz										
	Voltage Tolerance	±10%(342~528 V)										
	Frequency Tolerance	±5%(47~63 Hz)										
	Cooling Method	Fan Cooled										
Weight (kg)		8	10	10	13	13	13	36	36	36	50	50

 **NOTE**

**Rated Output Current for Elevators (A)

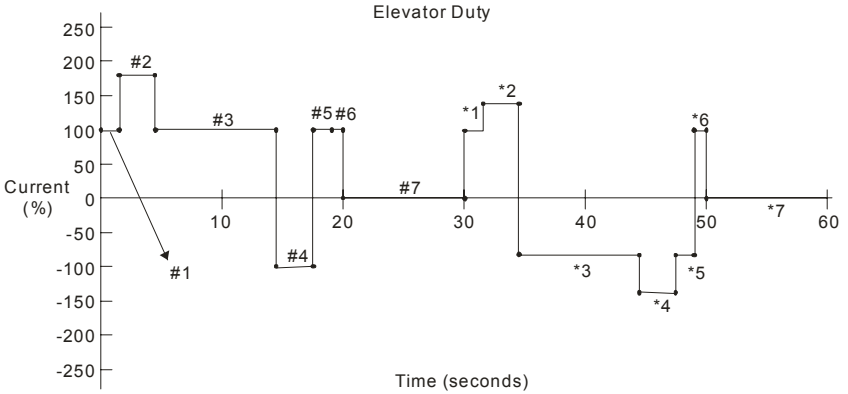

Event	Description	Time(s)	Current
#1	Per torque	1.5	100%
#2	Accel up	3	175%
#3	Cruise	10	100%
#4	Decel up	3	115%
#5	Post	1.5	140%
#6	Per torque	1	100%
#7	Rest	10	0%
*1	Per torque	1.5	100%
*2	Accel up	3	140%
*3	Cruise	10	80%
*4	Decel up	3	140%
*5	Post	1.5	140%
*6	Per torque	1	100%
*7	Rest	10	0%

General Specifications		
Control Characteristics	Control System	1: V/f, 2: VF+PG, 3: SVC, 4: FOC+PG, 5: TQR+PG, 6:FOC+PM
	Start Torque	Starting torque is 150% at 0.5Hz and 0Hz with control modes FOC + PG and FOC+PM
	Speed Control Range	1:100 Sensorless vector (up to 1:1000 when using PG card)
	Speed Control Resolution	±0.5% Sensorless vector (up to±0.02% when using PG card)
	Speed Response Ability	5Hz (up to 30Hz for vector control)
	Max. Output Frequency	0.00 to 120.00Hz
	Output Frequency Accuracy	Digital command ±0.005%, analog command ±0.5%
	Frequency Setting Resolution	Digital command ±0.01Hz, analog command: 1/4096(12-bit) of the max. output frequency
	Torque Limit	Max. is 200% torque current
	Torque Accuracy	±5%
	Accel/Decel Time	0.00 to 600.00/0.0 to 6000.0 seconds
	V/f Curve	Adjustable V/f curve using 4 independent points and square curve
Frequency Setting Signal	0-+10V, ±10V, 4~20mA	
Brake Torque	About 20%	
Protection Characteristics	Motor Protection	Electronic thermal relay protection
	Over-current Protection	The current forces 220% of the over-current protection and 300% of the rated current
	Ground Leakage Current Protection	Higher than 50% rated current
	Overload Ability	Constant torque: 150% for 60 seconds, variable torque: 200% for 3 seconds
	Over-voltage Protection	Over-voltage level: Vdc > 400/800V; low-voltage level: Vdc < 200/400V
	Over-voltage Protection for the Input Power	Varistor (MOV)
	Over-temperature Protection	Built-in temperature sensor
Environmental Conditions	Compensation for the Momentary Power Loss	Up to 5 seconds for parameter setting
	Protection Level	NEMA 1/IP20
	Operation Temperature	-10°C to 45°C
	Storage Temperature	-20°C to 60°C
	Ambient Humidity	Below 90% RH (non-condensing)
	Vibration	9.80665m/s ² (1G) less than 20Hz, 5.88m/s ² (0.6G) at 20 to 50Hz
	Installation Location	Altitude 1,000 m or lower, keep from corrosive gasses, liquid and dust
Approvals		

This page intentionally left blank

Appendix B Accessories

General Precautions



- This VFD-VL AC motor drive has gone through rigorous quality control tests at the factory before shipment. If the package is damaged during shipping, please contact your dealer.
 - The accessories produced by Delta are only for using with Delta AC motor drive. Do NOT use with other drive to prevent damage.
-

B.1 All Brake Resistors & Brake Units Used in AC Motor Drives

Applicable Motor		*1 125%Braking Torque 10%ED					*2 Max. Brake Torque		
HP	kW	Brake Unit	Resistor Value of Each AC Motor Drive	Brake Resistor		Total Braking Current (A)	Min. Resistor Value (Ω)	Max. Total Braking Current (A)	Peak Power (kW)
		VFDB		*3 Braking Resistor series for each Brake Unit					
7.5	5.5	-	1000W 20Ω	BR1K0W020*1	-	19	15.6	24.4	9.3
10	7.5	-	1500W 13Ω	BR1K5W013*1	-	29	11.5	33.0	12.5
15	11	-	1500W 13Ω	BR1K5W013*1	-	29	9.5	40.0	15.2
20	15	-	2000W 8.6Ω	BR1K0W4P3*2	2 Series	44	8.3	46.0	17.5
25	18	-	2400W 7.8Ω	BR1K2W3P9*2	2 Series	49	5.8	66.0	25.1
30	22	-	3000W 6.6Ω	BR1K5W3P3*2	2 Series	58	5.8	66.0	25.1
40	30	2015*2	4000W 5.1Ω	BR1K0W5P1*2	2 Series	75	4.8	80.0	30.4
50	37	2022*2	4800W 3.9Ω	BR1K2W3P9*2	2 Series	97	3.2	120.0	45.6

Applicable Motor		*1 125%Braking Torque 10%ED					*2 Max. Brake Torque		
HP	kW	Brake Unit	Resistor Value of Each AC Motor Drive	Brake Resistor		Total Braking Current (A)	Min. Resistor Value (Ω)	Max. Total Braking Current (A)	Peak Power (kW)
		VFDB		*3 Braking Resistor series for each Brake Unit					
7.5	5.5	-	1000W 75Ω	BR1K0W075*1	-	10.2	48.4	15.7	11.9
10	7.5	-	1500W 43Ω	BR1K5W043*1	-	17.6	39.4	19.3	14.7
15	11	-	1500W 43Ω	BR1K5W043*1	-	17.6	30.8	24.7	18.8
20	15	-	2000W 32Ω	BR1K0W016*2	2 Series	24	25.0	30.4	23.1
25	18	-	3000W 26Ω	BR1K5W013*2	2 Series	29	20.8	36.5	27.7
30	22	-	3000W 26Ω	BR1K5W013*2	2 Series	29	19.0	40.0	30.4
40	30	4030*1	3000W 20.4Ω	BR1K0W5P1*4	4 Series	37	19.0	40.0	30.4
50	37	4045*1	4800W 15Ω	BR1K2W015*4	2 parallel 2 Series	50	12.7	60.0	45.6
60	45	4045*1	6000W 13Ω	BR1K5W013*4	2 parallel 2 Series	59	12.7	60.0	45.6
75	55	4030*2	7200W 10Ω	BR1K2W015*4	4 Series	76	9.5	80.0	60.8
100	75	4045*2	9600W 7.5Ω	BR1K2W015*4	2 parallel 2 Series	100	6.3	120.0	91.2

*1 Calculation for 125% brake torque: (kw)*125%*0.8; where 0.8 is motor efficiency.

Because there is a resistor limit of power consumption, the longest operation time for 10%ED is 10sec (on: 10sec/ off: 90sec).

*2 Please refer to the Brake Performance Curve for "Operation Duration & ED" vs. "Braking Current".

*3 For heat dissipation, a resistor of 400W or lower should be fixed to the frame and maintain the surface temperature below 50°C; a resistor of 1000W and above should maintain the surface temperature below 350°C.

 **NOTE**

1. Please select the recommended resistance value (Watt) and the duty-cycle value (ED%).
2. Definition for Brake Usage ED%

Explanation: The definition of the brake usage ED(%) is for assurance of enough time for the brake unit and brake resistor to dissipate away heat generated by braking. When the brake resistor heats up, the resistance would increase with temperature, and brake torque would decrease accordingly. Recommended cycle time is one minute.

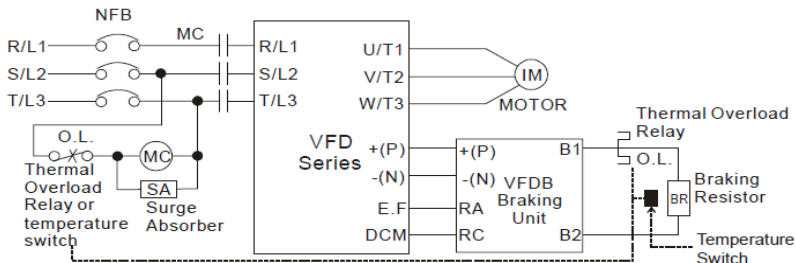
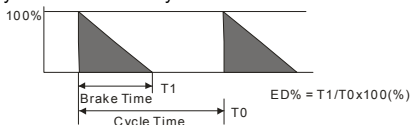

Note1: When using the AC drive with DC reactor, please refer to wiring diagram in the AC drive user manual for the wiring of terminal + (P) of Braking unit.

Note2: Do NOT wire terminal - (N) to the neutral point of power system.

3. For safety consideration, install an overload relay between the brake unit and the brake resistor. In conjunction with the magnetic contactor (MC) prior to the drive, it can perform complete protection against abnormality. The purpose of installing the thermal overload relay is to protect the brake resistor from damage due to frequent brake, or due to brake unit keeping operating resulted from unusual high input voltage. Under such circumstance, just turn off the power to prevent damaging the brake resistor.
4. If damage to the drive or other equipment are due to the fact that the brake resistors and the brake modules in use are not provided by Delta, the warranty will be void.
5. Take into consideration the safety of the environment when installing the brake resistors.
6. If the minimum resistance value is to be utilized, consult local dealers for the calculation of the Watt figures.
7. Please select thermal relay trip contact to prevent resistor over load. Use the contact to switch power off to the AC motor drive!
8. When using more than 2 brake units, equivalent resistor value of parallel brake unit can't be less than the value in the column "Minimum Equivalent Resistor Value for Each AC Drive" (the

Appendix B Accessories | VFD-VL

right-most column in the table).

9. This chart is for normal usage; if the AC motor drive is applied for frequent braking, it is suggested to enlarge 2~3 times of the Watts.

B.1.1 Dimensions and Weights for Brake Resistors

(Dimensions are in millimeter)

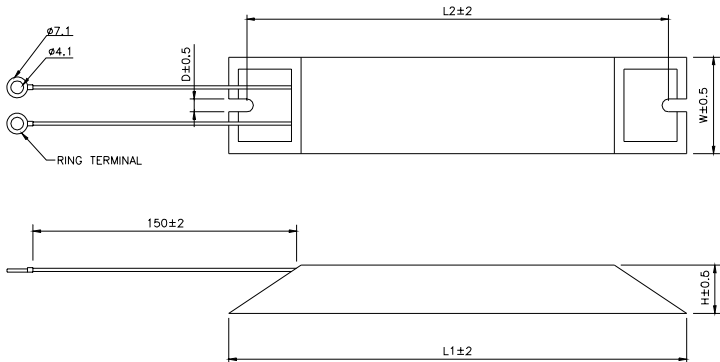

Model no.	L1	L2	H	D	W	Max. Weight (g)
BR080W200	140	125	20	5.3	60	160
BR080W750						
BR300W070	215	200	30	5.3	60	750
BR300W100						
BR300W250						
BR300W400						
BR400W150	265	250	30	5.3	60	930
BR400W040						

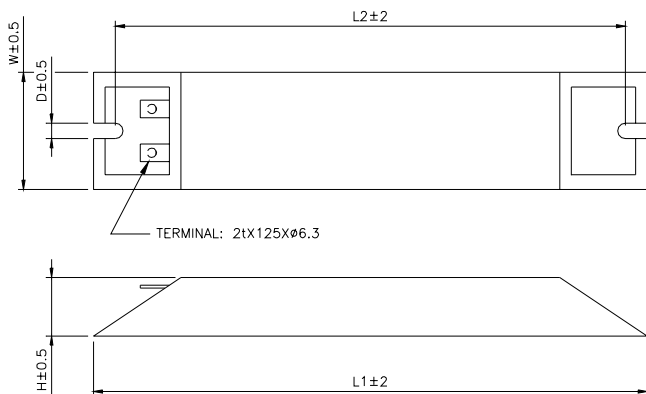

Model no.	L1	L2	H	D	W	Max. Weight (g)
BR500W030	335	320	30	5.3	60	1100
BR500W100						
BR1K0W020	400	385	50	5.3	100	2800
BR1K0W075						

Brake Resistor

Order P/N: BR1K0W050, BR1K2W008, BR1K2W6P8, BR1K5W005, BR1K5W040

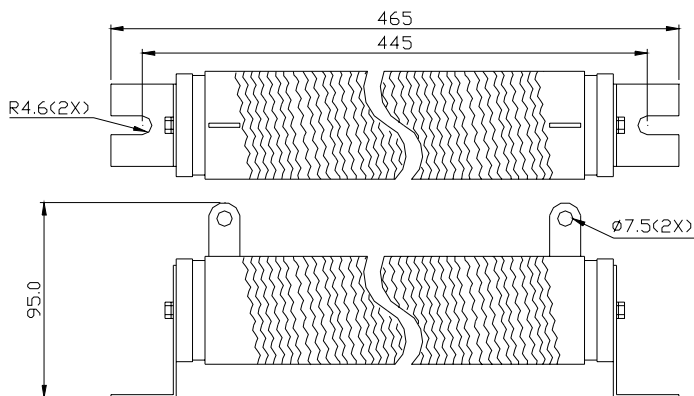

B.1.2 Specifications for Brake Unit

		230V Series		460V Series	
		2015	2022	4030	4045
Output Rating	Max. Motor Power (kW)	15	22	30	45
	Max. Peak Discharge Current (A) 10%ED	40	60	40	60
	Continuous Discharge Current (A)	15	20	15	18
	Brake Start-up Voltage (DC)	330/345/360/380/400/415±3V		660/690/720/760/800/830±6V	
Input Rating	DC Voltage	200~400VDC		400~800VDC	
Protection	Heat Sink Overheat	Temperature over +95°C (203 °F)			
	Alarm Output	Relay contact 5A 120VAC/28VDC (RA, RB, RC)			
	Power Charge Display	Blackout until bus (+~-) voltage is below 50VDC			
Environment	Installation Location	Indoor (no corrosive gases, metallic dust)			
	Operating Temperature	-10°C ~ +50°C (14°F to 122°F)			
	Storage Temperature	-20°C ~ +60°C (-4°F to 140°F)			
	Humidity	90% Non-condensing			
	Vibration	9.8m/s ² (1G) under 20Hz 2m/s ² (0.2G) at 20~50Hz			
Wall-mounted Enclosed Type		IP50			IP10

B.1.3 Dimensions for Brake Unit

VFDB2015, VFDB2022, VFDB4030, VFDB4045

(Dimensions are in millimeter[inch])

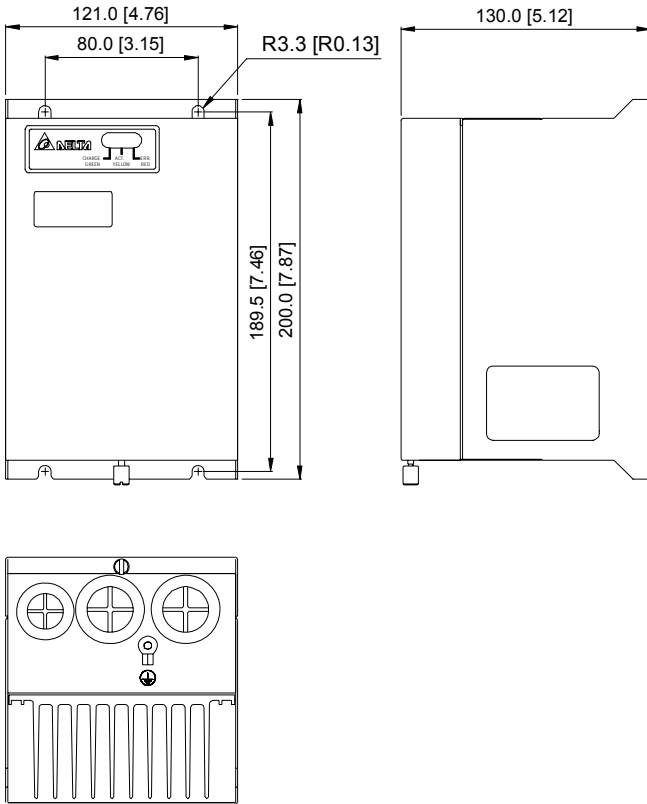

B.2 Non-fuse Circuit Breaker Chart

Comply with UL standard: Per UL 508, paragraph 45.8.4, part a,

The current rating of the breaker shall be within 2-4 times maximum input current rating.

3-phase			
Model	Recommended Input Current (A)	Model	Recommended Input Current (A)
VFD055VL23A	50	VFD220VL23A	175
VFD055VL43A	30	VFD220VL43A	100
VFD075VL23A	60	VFD300VL23A	225
VFD075VL43A	40	VFD300VL43A	125
VFD110VL23A	100	VFD370VL23A	250
VFD110VL43A	50	VFD370VL43A	150
VFD150VL23A	125	VFD450VL43A	175
VFD150VL43A	60	VFD550VL43A	250
VFD185VL23A	150	VFD750VL43A	300
VFD185VL43A	75		

B.3 Fuse Specification Chart

Smaller fuses than those shown in the table are permitted.

Model	I (A) Input	I (A) Output	Line Fuse	
			I (A)	Bussmann P/N
VFD055VL23A	26	25	50	JJN-50
VFD055VL43A	14	13	30	JJN-30
VFD075VL23A	34	33	60	JJN-60
VFD075VL43A	19	18	40	JJN-40
VFD110VL23A	50	49	100	JJN-100
VFD110VL43A	25	24	50	JJN-50
VFD150VL23A	60	65	125	JJN-125
VFD150VL43A	32	32	60	JJN-60
VFD185VL23A	75	75	150	JJN-150
VFD185VL43A	39	38	75	JJN-70
VFD220VL23A	90	90	175	JJN-175
VFD220VL43A	49	45	100	JJN-100

Appendix B Accessories | VFD-VL

Model	I (A) Input	I (A) Output	Line Fuse	
			I (A)	Bussmann P/N
VFD300VL23A	110	120	225	JJN-225
VFD300VL43A	60	60	125	JJN-125
VFD370VL23A	142	145	250	JJN-250
VFD370VL43A	63	73	150	JJN-150
VFD450VL43A	90	91	175	JJN-175
VFD550VL43A	130	110	250	JJN-250
VFD750VL43A	160	150	300	JJN-300

B.4 AC Reactor

B.4.1 AC Input Reactor Recommended Value

460V, 50/60Hz, 3-Phase

kW	HP	Fundamental Amps	Max. continuous Amps	Inductance (mH)	
				3% impedance	5% impedance
5.5	7.5	12	18	2.5	4.2
7.5	10	18	27	1.5	2.5
11	15	25	37.5	1.2	2
15	20	35	52.5	0.8	1.2
18.5	25	35	52.5	0.8	1.2
22	30	45	67.5	0.7	1.2
30	40	55	82.5	0.5	0.85
37	50	80	120	0.4	0.7
45	60	80	120	0.4	0.7
55	75	100	150	0.3	0.45
75	100	130	195	0.2	0.3

B.4.2 AC Output Reactor Recommended Value

230V, 50/60Hz, 3-Phase

kW	HP	Fundamental Amps	Max. continuous Amps	Inductance (mH)	
				3% impedance	5% impedance
5.5	7.5	25	37.5	0.5	1.2
7.5	10	35	52.5	0.4	0.8
11	15	55	82.5	0.25	0.5
15	20	80	120	0.2	0.4
18.5	25	80	120	0.2	0.4
22	30	100	150	0.15	0.3
30	40	130	195	0.1	0.2
37	50	160	240	0.075	0.15

460V, 50/60Hz, 3-Phase

kW	HP	Fundamental Amps	Max. continuous Amps	Inductance (mH)	
				3% impedance	5% impedance
5.5	7.5	18	27	1.5	2.5
7.5	10	18	27	1.5	2.5
11	15	25	37.5	1.2	2
15	20	35	52.5	0.8	1.2
18.5	25	45	67.5	0.7	1.2
22	30	45	67.5	0.7	1.2
30	40	80	120	0.4	0.7
37	50	80	120	0.4	0.7
45	60	100	150	0.3	0.45
55	75	130	195	0.2	0.3
75	100	160	240	0.15	0.23

B.4.3 Applications for AC Reactor

Connected in input circuit

Application 1	Question
When more than one AC motor drive is connected to the same power, one of them is ON during operation.	When applying to one of the AC motor drive, the charge current of capacity may cause voltage ripple. The AC motor drive may damage when over current occurs during operation.

Correct wiring

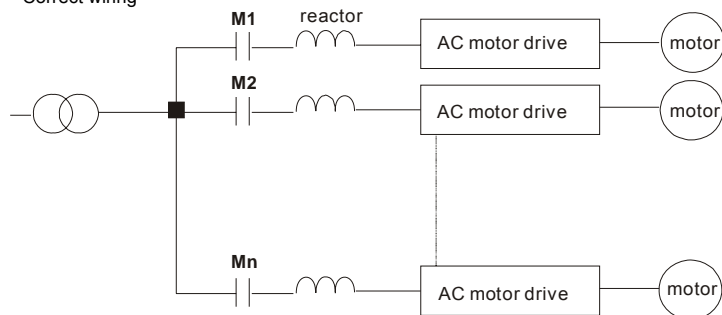

Application 2	Question
Silicon rectifier and AC motor drive is connected to the same power.	Surges will be generated at the instant of silicon rectifier switching on/off. These surges may damage the mains circuit.

Correct wiring

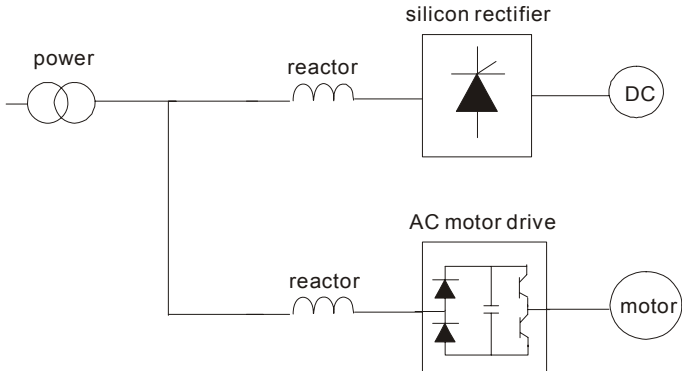

Application 3	Question
Used to improve the input power factor, to reduce harmonics and provide protection from AC line disturbances (surges, switching spikes, short interruptions, etc.). AC line reactor should be installed when the power supply capacity is 500kVA or more and exceeds 6 times the inverter capacity, or the mains wiring distance $\leq 10\text{m}$.	When power capacity is too large, line impedance will be small and the charge current will be too large. That may damage AC motor drive due to higher rectifier temperature.

Correct wiring

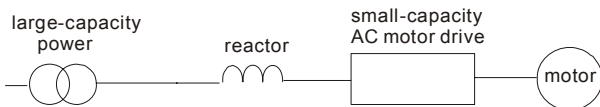

B.5 Zero Phase Reactor (RF220X00A)

Dimensions are in millimeter and (inch)

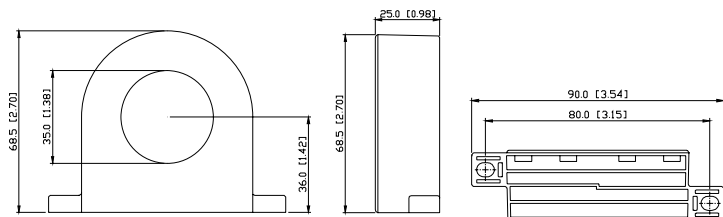

Cable type (Note)	Recommended Wire Size			Qty.	Wiring Method
	AWG	mm ²	Nominal (mm ²)		
Single-core	≤ 10	≤ 5.3	≤ 5.5	1	Diagram A
	≤ 2	≤ 33.6	≤ 38	4	Diagram B
Three-core	≤ 12	≤ 3.3	≤ 3.5	1	Diagram A
	≤ 1	≤ 42.4	≤ 50	4	Diagram B

Note: 600V Insulated unshielded Cable.

Note 1: The table above gives approximate wire size for the zero phase reactors but the selection is ultimately governed by the type and diameter of cable fitted i.e. the cable must fit through the center hole of zero phase reactors.

Note 2: Only the phase conductors should pass through, not the earth core or screen.

Note 3: When long motor output cables are used an output zero phase reactor may be required to reduce radiated emissions from the cable

Diagram A

Please wind each wire 4 times around the core. The reactor must be put at inverter output as close as possible.

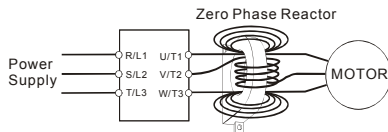
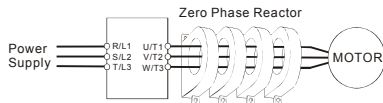

Diagram B

Please put all wires through 4 cores in series without winding.



B.6 DC Choke Recommended Values

230V DC Choke

Input voltage	kW	HP	DC Amps	Inductance (mh)
230Vac 50/60Hz 3-Phase	5.5	7.5	32	0.85
	7.5	10	40	0.75
	11	15	62	Built-in
	15	20	92	Built-in
	18.5	25	110	Built-in
	22	30	125	Built-in
	30	40	-	Built-in
	37	50	-	Built-in

460V DC Choke

Input voltage	kW	HP	DC Amps	Inductance (mh)
460Vac 50/60Hz 3-Phase	5.5	7.5	18	3.75
	7.5	10	25	4.00
	11	15	32	Built-in
	15	20	50	Built-in
	18.5	25	62	Built-in
	22	30	80	Built-in
	30	40	92	Built-in
	37	50	110	Built-in
	45	60	125	Built-in
	55	75	200	Built-in
	75	100	240	Built-in







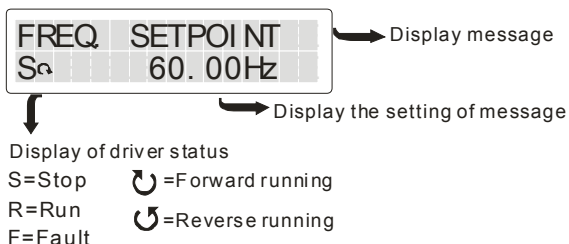

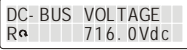

B.7 Digital Keypad KPVL-CC01

The digital keypad is the display of VFD-VL series. The following keypad appearance is only for reference and please see the product for actual appearance.

B.7.1 Description of the Digital Keypad KPVL-CC01

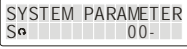

Display Message	Descriptions
<p>Press MODE key</p>	Displays the AC drive Master Frequency
<p>Press MODE key</p>	Displays the actual output frequency present at terminals U/T1, V/T2, and W/T3

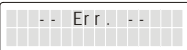
Display Message	Descriptions
 <p>Press MODE key</p>	Displays the voltage of DC BUS
 <p>Press MODE key</p>	Displays the output current present at terminals U/T1, V/T2, and W/T3
 <p>Press MODE key</p>	Displays the output voltage of motor
 <p>Press MODE key</p>	User defined unit (Where U= Pr.00-04)
	Copy the first set of parameter groups from the drive to the keypad. It can save two sets of parameter groups to keypad. (one set is from group 0 to group 13)
	Save the first set of parameter groups from the keypad to other drive. The firmware version is 1.00.
	Displays the group number
	Displays the actual stored value of the selected parameter
	External Fault
	Display "End" for approximately 1 second if input has been accepted by pressing PROG/DATA key. After a parameter value has been set, the new value is automatically stored in memory.
	Display "Err", if the input is invalid.

B.7.2 How to Operate the Digital Keypad KPVL-CC01

Selection Mode

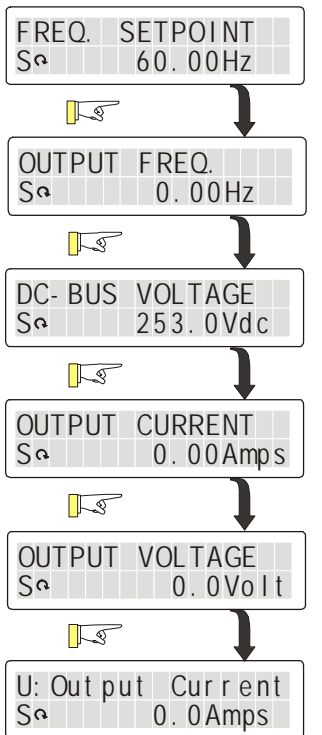

return to the start-up display

In the selection mode, press

to set the parameters.

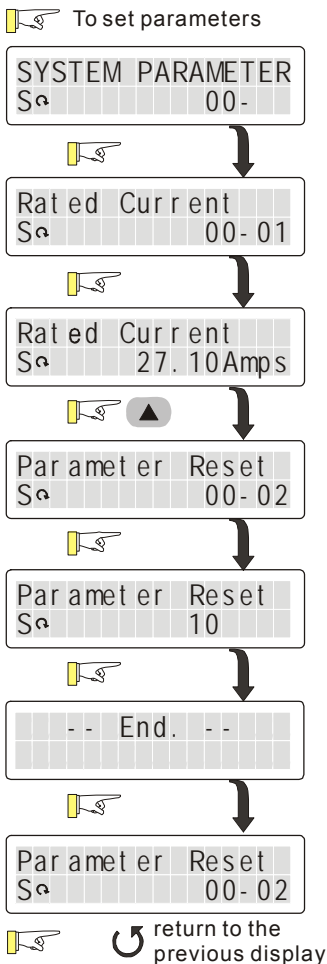

return to the previous display

In the parameters mode, it will display parameters and parameters definitions

To copy parameters

From drive to KPVL-CC01

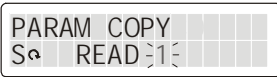

Press and hold on for about 5 seconds

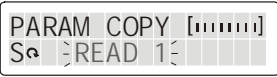

When "READ 1" starts blinking, it starts to save to KPVL-CC01.

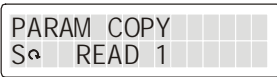

Finish to save parameters

From KPVL-CC01 to drive

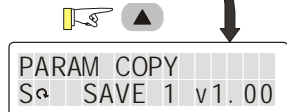

Press and hold on for about 5 seconds



When "SAVE 1" starts blinking, it starts to save to KPVL-CC01. V1.00 is the firmware version. It fails to save to KPVL-CC01 when it displays V --.--. It needs to save parameters from drive to KPVL-CC01 first.

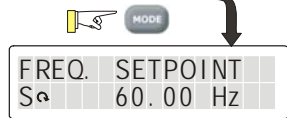

When entering error parameters setting

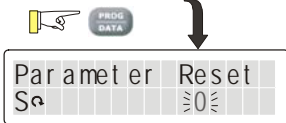

Enter parameter settings

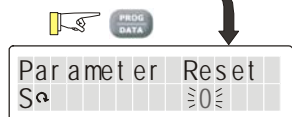
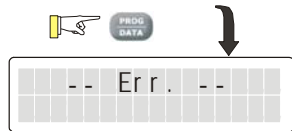

Please re-enter the correct value when the setting is blinking.

B.7.3 Dimension of the Digital Keypad

Unit: mm [inch]

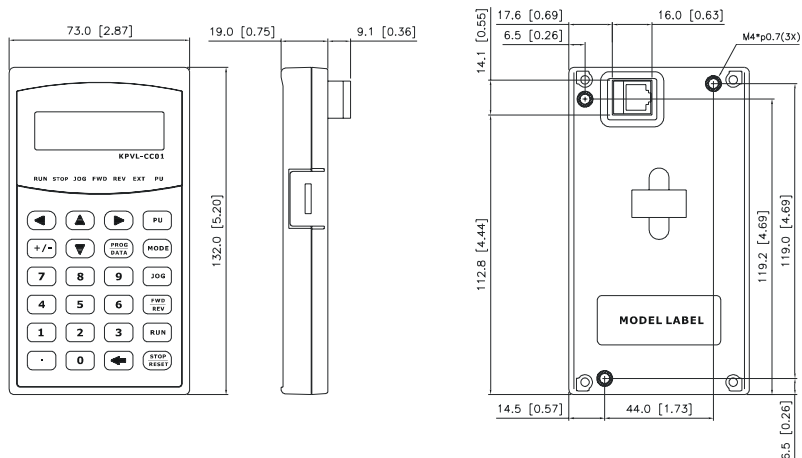

B.7.4 Recommended Position the Rubber Magnet of the Digital Keypad

This rubber magnet is shipped with the digital keypad. Users can adhere to anywhere of the back of the digital keypad to stick on the case of the AC motor drive. Please don't stick on the communication port to prevent reducing magnetic force.

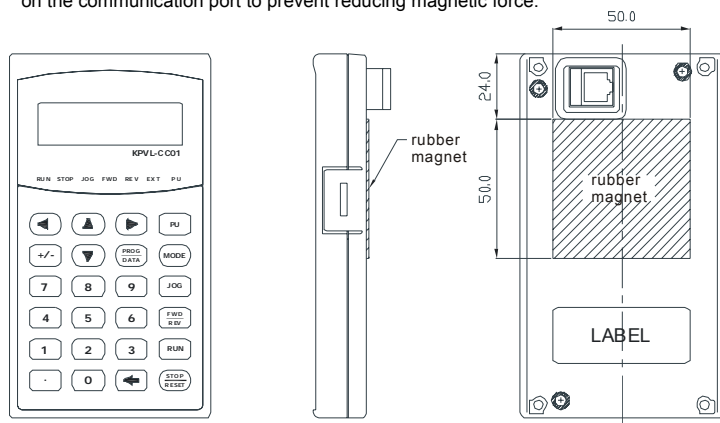

B.8 PG Card (for Encoder)

B.8.1 EMVL-PGABL-1



1. Terminals descriptions

Terminal Symbols		Descriptions	Specifications
TB1	VP	Power source of encoder (use SW2 to switch 12V/5V)	Voltage: +5V±0.5V or +12V±1V Current: 200mA max.
	0V	Power source common for encoder	Reference level of the power of encoder
	A, \bar{A} , B, \bar{B} , Z, \bar{Z}	Incremental line driver input	Line driver RS422 Max. input frequency: 100 kHz
	U, \bar{U} , V, \bar{V} , W, \bar{W}	Absolute line driver input (UVW 3-bit code)	Line driver RS422 Max. input frequency: 50 kHz
	A/O, \bar{A}/O , B/O, \bar{B}/O , Z/O, \bar{Z}/O	Signal output for PG feedback card and can be used as a frequency divider.	Line driver RS422 Max. output frequency: 100 kHz
J3	⊕	Grounding	Connected to the grounding of the power of the AC motor drive and used for PG shielding

2. Wire length

Types of Pulse Generators	Maximum Wire Length	Wire Gauge
Line Driver	100m	1.25mm ² (AWG16) or above

3. Types of Pulse Generators (Encoders)

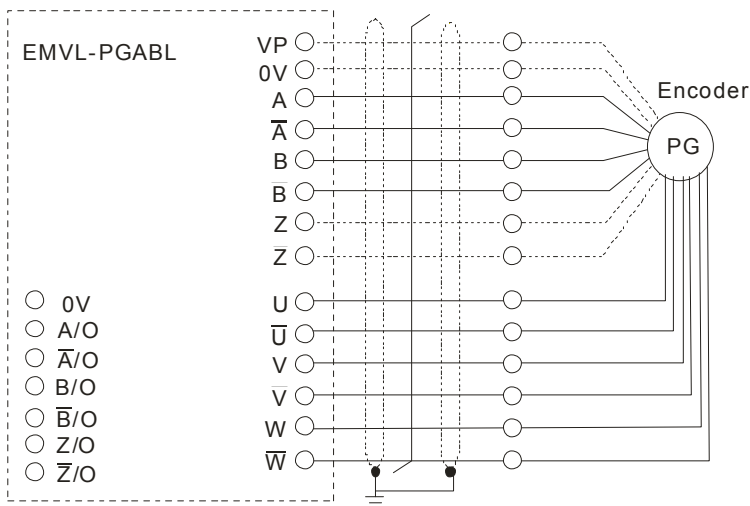
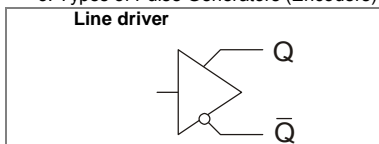

4. Output Signal Setting of the Frequency Divider

It generates the output signal of division factor "n" after dealing with the input pulse. Please set by the switch SW1 on the card.

- RESERVE: reserved bit (PIN1)
- I/MODE: input type setting of the division pulse (PIN 2)
- O/MODE: output type setting of the division pulse (PIN 3)
- RST: clock reset bit (PIN 4)
- Division factor: setting for division factor n: 1~256 (PIN5~12)

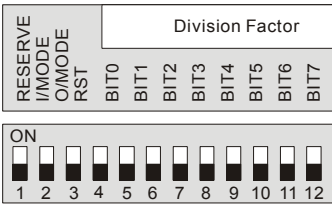

Settings and explanations

RESERVE	I/MODE	O/MODE	RST	Division factor	
				A leads B	B leads A
X	0	0	1	A-/A B-/B A/O-/A/O B/O-/B/O	A-/A B-/B A/O-/A/O B/O-/B/O
X	0	1	1	A-/A B-/B A/O-/A/O B/O-/B/O	A-/A B-/B A/O-/A/O B/O-/B/O
X	1	X	1	A-/A B-/B A/O-/A/O B/O-/B/O	A-/A B-/B A/O-/A/O B/O-/B/O



- When the switch is ON, it means logic 0.
- A-/A and B-/B are the input signals of PG card. A/O-/A/O and B/O-/B/O are the line driver outputs of the frequency divider measured by the differential probe.
- PIN1 is reserved.
- PIN 5~12 are the denominator for the frequency divider. PIN 5 is the low bit (EX: the setting of XXXX10101010 is that the input signal divides by 85).

- When PIN 2 and PIN 3 are set to 0, the input signals (A-/A and B-/B) of PG card should be square wave and A/O-/A/O and B/O-/B/O are the outputs of frequency divider.
- When PIN 2 is set to 0 and PIN 3 is set to 1, the input signals (A-/A and B-/B) of PG card should be square wave and B/O-/B/O is the indication of phase A and B. (EX: LOW means A leads B and HIGH means B leads A). A/O-/A/O is the output of frequency divider.
- When PIN 2 is set to 1 and PIN 3 is set to X, B-/B should be the input signal of direction indication. (EX: when B-/B is LOW, it means that A leads B. When B-/B is HIGH, it means that B leads A. A-/A is a square wave input. B/O-/B/O and B-/B should be input synchronously. A/O-/A/O is the output of frequency divider.
- Z/O-/Z/O of the PG card will act by the input signal of Z-/Z and don't have the function of frequency divider.
- When changing the denominator of the frequency divider or input/output type, it needs to clear the counter value by clock reset bit (PIN4) before operation. Please set the switch to 1 after reset.

B.8.2 EMVL-PGABO





Terminals descriptions

Terminal Symbols	Descriptions	Specifications	
VP	Power source of encoder	Voltage: +12V±1V Current: 200mA max.	
0V	Power source common for encoder	Reference level of the power of encoder	
A, \bar{A} , B, \bar{B} , Z, \bar{Z}	Incremental line driver input	Open collector signal input. Max. bandwidth is 100kHz Please notice that \bar{A} , \bar{B} , \bar{Z} and 0V should be short circuit.	
TB1	A/O, \bar{A} /O, B/O, \bar{B} /O, Z/O, \bar{Z} /O	Pulse output for PG feedback card and can be used as a frequency divider.	Line driver RS422 Max. output frequency: 100 kHz
	O/A · O/B	Pulse output for PG feedback card and can be used as a frequency divider.	Open loop Max. output frequency 100kHz Max. 24Vdc, 50mA
	Vc	Signal output for power input side	Voltage: +24V±1V Current : 50mA
	⊖	Grounding	Connected to the grounding of the power of the AC motor drive and used for PG shielding

2. Wire length

Output Type of the Encoder	Maximum Wire Length	Wire Gauge
Open collector	50m	1.25mm ² (AWG16) or above

3. Output Type of Encoder

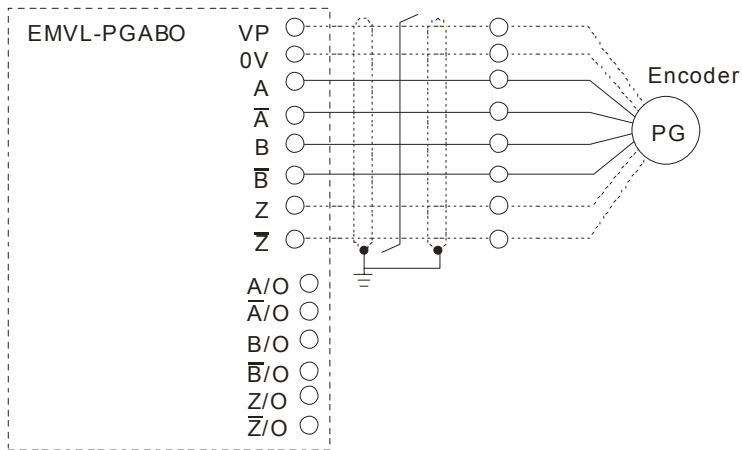
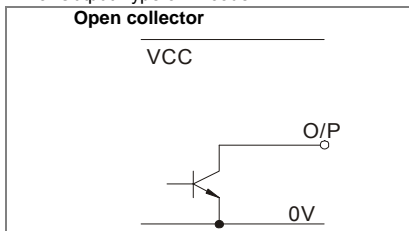

4. Output Signal Setting of the Frequency Divider

It generates the output signal of division factor "n" after dealing with the input pulse. Please set by the switch SW1 on the card.

RESERVE: reserved bit (PIN1)

I/MODE: input type setting of the division pulse (PIN 2)

O/MODE: output type setting of the division pulse (PIN 3)

RST: clock reset bit (PIN 4)

Division factor: setting for division factor n: 1~256 (PIN5~12)

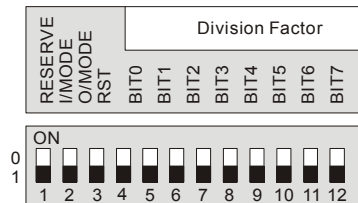

Settings and explanations

RESERVE	I/MODE	O/MODE	RST	Division factor	
				A leads B	B leads A
X	0	0	1		
X	0	1	1		
X	1	X	1		

**NOTE**

- When the switch is ON, it means logic 0.
- A-/A and B-/B are the input signals of PG card. A/O-/A/O and B/O-/B/O are the line driver outputs of the frequency divider measured by the differential probe.
- PIN1 is reserved.
- PIN 5~12 are the denominator for the frequency divider. PIN 5 is the low bit (EX: the setting of XXXX10101010 is that the input signal divides by 85).
- When PIN 2 and PIN 3 are set to 0, the input signals (A-/A and B-/B) of PG card should be square wave and A/O-/A/O and B/O-/B/O are the outputs of frequency divider.
- When PIN 2 is set to 0 and PIN 3 is set to 1, the input signals (A-/A and B-/B) of PG card should be square wave and B/O-/B/O is the indication of phase A and B. (EX:

LOW means A leads B and HIGH means B leads A). A/O-/A/O is the output of frequency divider.

- When PIN 2 is set to 1 and PIN 3 is set to X, B-/B should be the input signal of direction indication. (EX: when B-/B is LOW, it means that A leads B. When B-/B is HIGH, it means that B leads A. A-/A is a square wave input. B/O-/B/O and B-/B should be input synchronously. A/O-/A/O is the output of frequency divider.
- Z/O-/Z/O of the PG card will act by the input signal of Z-/Z and don't have the function of frequency divider.
- When changing the denominator of the frequency divider or input/output type, it needs to clear the counter value by clock reset bit (PIN4) before operation. Please set the switch to 1 after reset.

Wiring Method

Encoder Feedback

1. If the encoder type is line driver, the PG card will only output +12V signal. Set switch SW2 to EXT24V.

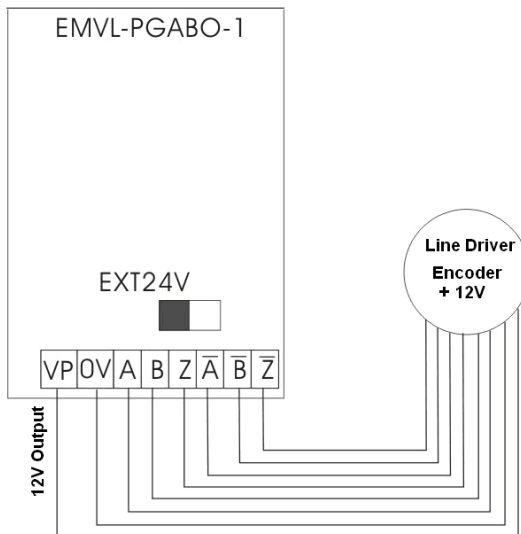

2. If the encoder type is open collector, wire connection method shown in the figure below can be used. For terminals \bar{A} 、 \bar{B} 、 \bar{Z} , set switch SW2 to INT12V.

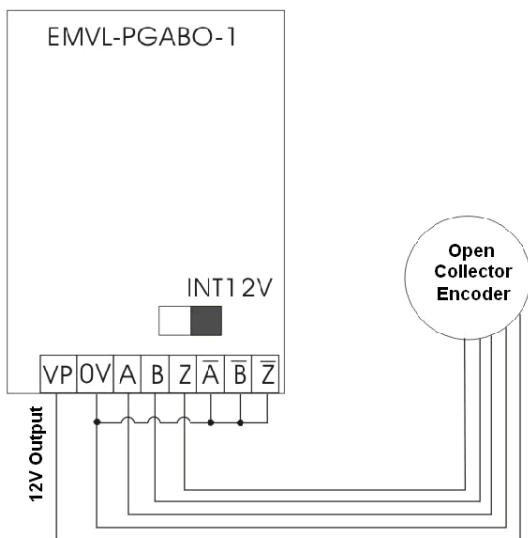

Pulse Output of PG Card

1. Common voltage input terminal S/S

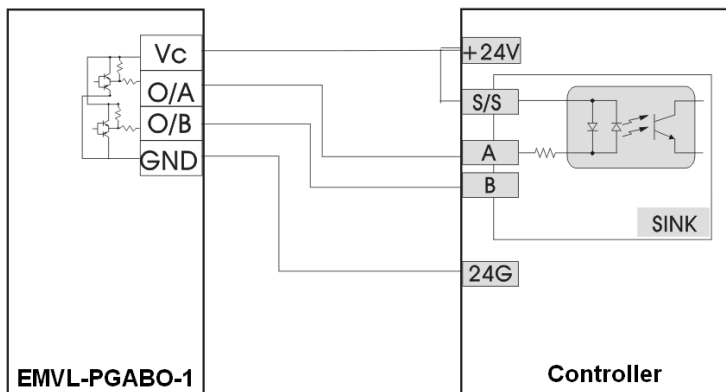

2. Common voltage output terminal S/S

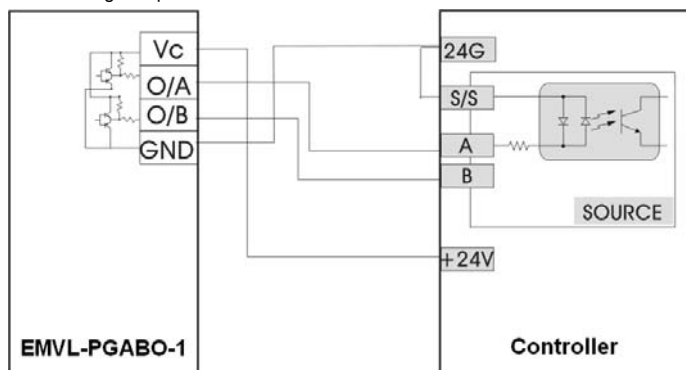

3. If the encoder type is line driver, when switch SW2 is set to +12V or +24V, the PG card will only output 5V.

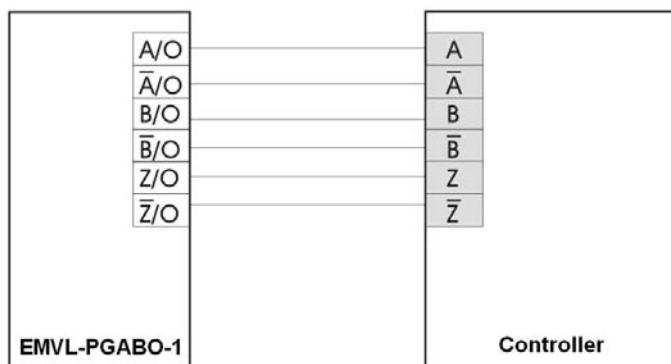

■

B.8.3 EMVL-PGH01 (only for Heidenhain ERN1387)

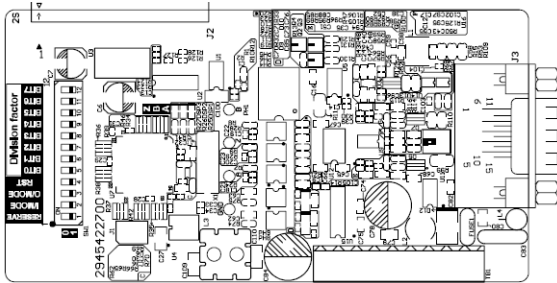

1. Sinusoidal Encoder Function

VFD-VL series

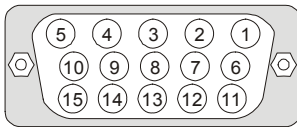

Pin NO	Terminal Name	Pin NO	Terminal Name
1	B-	9	+5V
2	NC	10	SIN
3	Z+	11	SIN'
4	Z-	12	COS
5	A+	13	COS'
6	A-	14	NC
7	0V	15	NC
8	B+		

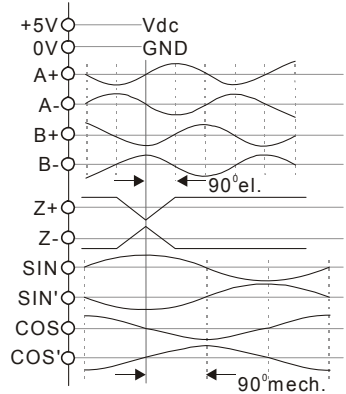

Heidenhain ERN1387

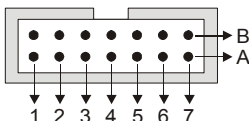

Pin NO	Terminal Name	Pin NO	Terminal Name
5a	B-	1b	UP
NC	NC	1a	C-
4b	R+	7b	C+
4a	R-	2b	D+
6a	A+	6a	D-
2a	A-	-	-
5b	0V	-	-
3b	B+		

2. Terminals descriptions

Terminal Symbols		Descriptions	Specifications
J3	+5V	Specific power output of encoder	Voltage: +5V±0.5V Current: 200mA max.
	0V	Power source common for encoder	Reference level of the power of encoder
	A+, A-, B+, B-, Z+, Z-	Sine line driver input (incremental signal)	
J3	SIN, SIN', COS, COS'	Sine line driver input signal (absolute signal)	
	A/O, \bar{A}/O , B/O, \bar{B}/O , Z/O, \bar{Z}/O	Signal output for PG feedback card and can be used as a frequency divider.	Line driver RS422 Max. output frequency: 100 kHz

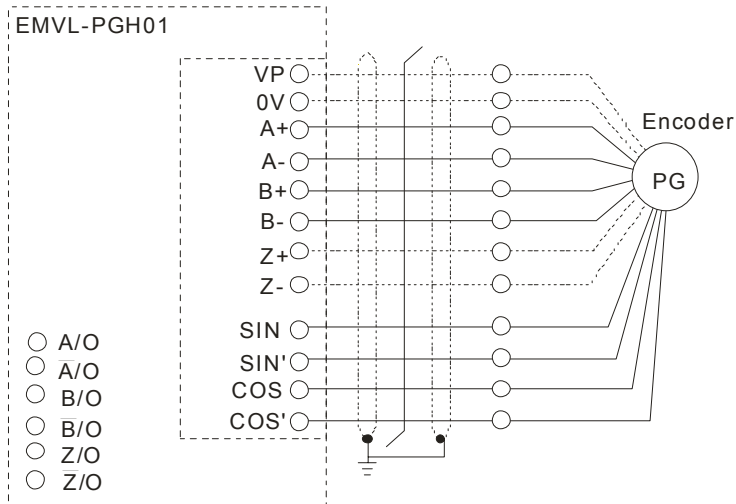

4. Output Signal Setting of the Frequency Divider

It generates the output signal of division factor "n" after dealing with the input pulse. Please set by the switch SW1 on the card.

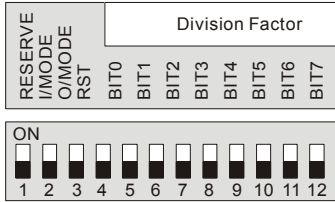

RESERVE: reserved bit (PIN1)

I/MODE: input type setting of the division pulse (PIN 2)

O/MODE: output type setting of the division pulse (PIN 3)

RST: clock reset bit (PIN 4)

Division factor: setting for division factor n: 1~256 (PIN5~12)

Settings and explanations

RESERVE	I/MODE	O/MODE	RST	Division factor	
				A leads B	B leads A
X	0	0	1		
X	0	1	1		
X	1	X	1	This setting is NOT for EMVL-PGH01	



- When the switch is ON, it means logic 0.
- A-/A and B-/B are the input signals of PG card. A/O-/A/O and B/O-/B/O are the line drivers of the frequency divider measured by the differential probe.
- PIN1 is reserved.
- PIN 5~12 are the denominator for the frequency divider. PIN 5 is the low bit (EX: the setting of XXXX10101010 is that the input signal divides by 85).
- When PIN 2 and PIN 3 are set to 0, the input signals (A-/A and B-/B) of PG card should be square wave and A/O-/A/O and B/O-/B/O are the outputs of frequency divider.
- When PIN 2 is set to 0 and PIN 3 is set to 1, the input signals (A-/A and B-/B) of PG card should be square wave and B/O-/B/O is the indication of phase A and B. (EX: LOW means A leads B and HIGH means B leads A). A/O-/A/O is the output of frequency divider.
- When PIN 2 is set to 1 and PIN 3 is set to X, B-/B should be the input signal of direction indication. (EX: when B-/B is LOW, it means that A leads B. When B-/B is HIGH, it means that B leads A. A-/A is a square wave input. B/O-/B/O and B-/B should be input synchronously. A/O-/A/O is the output of frequency divider.

- Z/O-/Z/O of the PG card will act by the input signal of Z-/Z and don't have the function of frequency divider.
- When changing the denominator of the frequency divider or input/output type, it needs to clear the counter value by clock reset bit (PIN4) before operation. Please set the switch to 1 after reset.

B.8.4 EMVL-PGS01

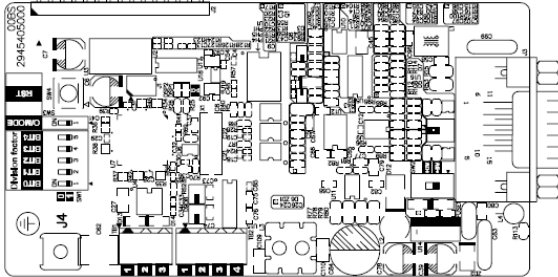

Applicable encoders for EMVL-PGS01:

- *EnDat2.1*: EQN425, EQN1325, ECN113, ECN413, ECN1113, ECN1313
- *HIPERFACE*: SRS50/60

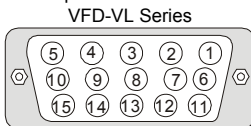

1. Pin description

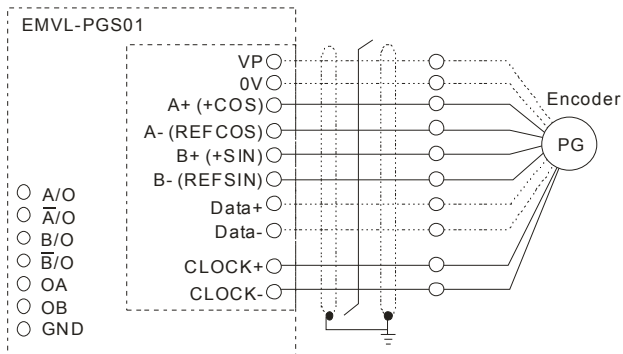

VFD-VL Series Pin No.	Corresponding terminal	
	EnDat	HIPERFACE®
1	B-	REFSIN
2	0V	0V
3	0V	0V
4	0V	0V
5	A+	+COS
6	A-	REFCOS
7	0V	0V
8	B+	+SIN
9	VP	VP
10	Data+	Data+
11	Data-	Data-
12	CLOCK+	-
13	CLOCK-	-
14	VP	VP
15	0V	0V

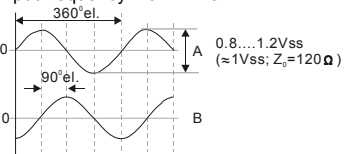
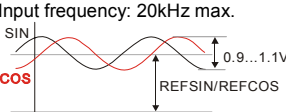

2. Terminals descriptions

Terminal Symbols		Descriptions	Specifications
J3	VP	Power source of encoder (use SW2 to switch 12V/5V)	Voltage: +5VDC±5% or +8.3 VDC±6% Current: 250mA max.
	0V	Power source common for encoder	Reference level of the power of encoder
	A+, A-, B+, B-	Sine line drive input (incremental signal)	Input frequency: 40kHz max. 
	+SIN, +COS REFSIN, REFCOS	Sine line drive input (incremental signal)	Input frequency: 20kHz max. 
	CLOCK+, CLOCK-	CLOCK line drive output	Line Driver RS422 Level output
	Data+, Data-		RS485 communication interface Terminal resistor: about 130 Ω
TB1	A/O, \bar{A} /O, B/O, \bar{B} /O	Signal output for PG feedback card and can be used as a frequency divider.	Line Driver RS422 Level output
TB2	OA OB	Open collector output signal and can be used as a frequency divider	<ul style="list-style-type: none"> • Transistor open collector output • Max. 24VDC, 30mA • $VOL \leq 1.5V (IOL=30mA)$ • $IOH \leq 200\mu A (VOH=24VDC)$
	GND	Open collector output common	Reference level of NPN transistor open collector output
J4		Grounding	Connected to the grounding of the power of the AC motor drive and used for PG shielding

4. Output Signal Setting of the Frequency Divider

It generates the output signal of division factor "n" after dealing with the input pulse. Please set by the switch SW1 on the card.

O/MODE: output type setting of the division pulse

RST: clock reset bit

Division factor: setting for division factor: n
1~31

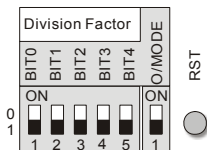

O/MODE	Division factor	
	A leads B	B leads A
0		
1		

**NOTE**

- When the switch is ON, it means logic 0.
- A-/A and B-/B are the input signals of PG card. A/O-/A/O and B/O-/B/O are the line driver outputs of the frequency divider measured by the differential probe.
- Bit 0-4 are the denominators for the frequency divider. Bit 0 is the low bit (EX: the setting of 10110 is that the input signal divides by 13).
- When the output pulse type of frequency divider is set to 0, A/O-/A/O, B/O-/B/O, OA-GND and OB-GND are the outputs of frequency divider.
- When the output pulse type of frequency divider is set to 1, B/O-/B/O and OB-GND are the indication of phase A and B. (EX: LOW means A leads B and HIGH means B leads A). A/O-/A/O and OA-GND are the output of frequency dividers.
- When changing the denominator of the frequency divider or output type, it needs to clear the counter value by clock reset bit before operation.

B.9 AMD-EMI Filter Cross Reference

230V 3-phase Model	Filter Model Name	230V 3-phase Model	Filter Model Name
VFD055VL23A	KMF336A	VFD055VL43A	KMF318A
VFD075VL23A	KMF336A	VFD075VL43A	KMF325A
VFD110VL23A	KMF350A	VFD110VL43A	KMF325A
VFD150VL23A	KMF370A	VFD150VL43A	KMF336A
VFD185VL23A	KMF3100A	VFD185VL43A	KMF350A
VFD220VL23A	KMF3100A	VFD220VL43A	KMF350A
VFD300VL23A	KMF3150A	VFD300VL43A	KMF370A
VFD370VL23A	KMF3150A	VFD370VL43A	KMF370A
		VFD450VL43A	KMF3100A
		VFD550VL43A	KMF3150A
		VFD750VL43A	KMF3150A

For more detail information of filter, please see <http://www.dem-uk.com/jkcm/Home>

Installation

All electrical equipment, including AC motor drives, will generate high-frequency/low-frequency noise and will interfere with peripheral equipment by radiation or conduction when in operation. By using an EMI filter with correct installation, much interference can be eliminated. It is recommended to use DELTA EMI filter to have the best interference elimination performance.

We assure that it can comply with following rules when AC motor drive and EMI filter are installed and wired according to user manual:

- EN61000-6-4
- EN61800-3: 1996
- EN55011 (1991) Class A Group 1

General precaution

1. EMI filter and AC motor drive should be installed on the same metal plate.
2. Please install AC motor drive on footprint EMI filter or install EMI filter as close as possible to the AC motor drive.
3. Please wire as short as possible.
4. Metal plate should be grounded.
5. The cover of EMI filter and AC motor drive or grounding should be fixed on the metal plate and the contact area should be as large as possible.

Choose suitable motor cable and precautions

Improper installation and choice of motor cable will affect the performance of EMI filter. Be sure to observe the following precautions when selecting motor cable.

1. Use the cable with shielding (double shielding is the best).

- The shielding on both ends of the motor cable should be grounded with the minimum length and maximum contact area.
- Remove any paint on metal saddle for good ground contact with the plate and shielding.

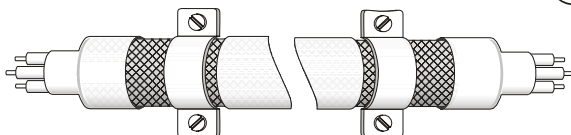
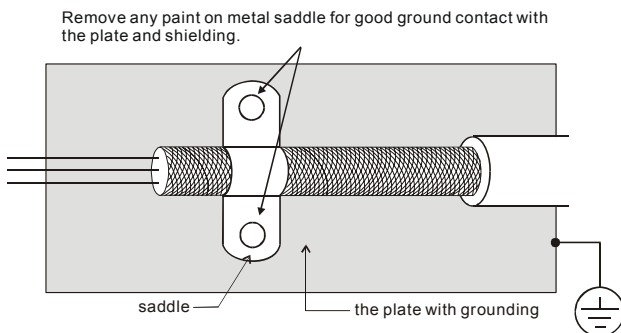

Saddle on both ends

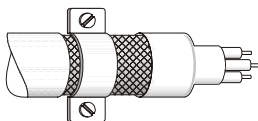

Saddle on one end

The length of motor cable

When motor is driven by an AC motor drive of PWM type, the motor terminals will experience surge voltages easily due to components conversion of AC motor drive and cable capacitance. When the motor cable is very long (especially for the 460V series), surge voltages may reduce insulation quality. To prevent this situation, please follow the rules below:

- Use a motor with enhanced insulation.
- Connect an output reactor (optional) to the output terminals of the AC motor drive
- The length of the cable between AC motor drive and motor should be as short as possible (10 to 20 m or less)
- For models 7.5hp/5.5kW and above:

Insulation level of motor	1000V	1300V	1600V
460VAC input voltage	66 ft (20m)	328 ft (100m)	1312 ft (400m)
230VAC input voltage	1312 ft (400m)	1312 ft (400m)	1312 ft (400m)

 **NOTE**

When a thermal O/L relay protected by motor is used between AC motor drive and motor, it may malfunction (especially for 460V series), even if the length of motor cable is only 165 ft (50m) or less. To prevent it, please use AC reactor and/or lower the carrier frequency (Pr. 00-17 PWM carrier frequency).

 **NOTE**

Never connect phase lead capacitors or surge absorbers to the output terminals of the AC motor drive.

- If the length is too long, the stray capacitance between cables will increase and may cause leakage current. It will activate the protection of over current, increase leakage current or not insure the correction of current display. The worst case is that AC motor drive may damage.
- If more than one motor is connected to the AC motor drive, the total wiring length is the sum of the wiring length from AC motor drive to each motor.

B.10 EMVL-IOA01

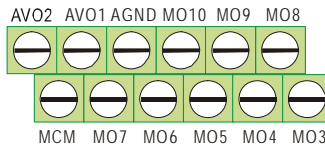

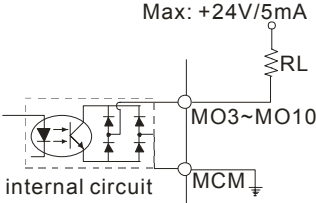
Terminals	Descriptions
AVO1-AGND AVO2-AGND	Multifunction analog voltage output terminal -10.0V~10.0V The analog output is defined by Pr.03-17 and Pr.03-20.
MO3~MO10 Multifunction output terminals (photocoupler)	The AC motor drive outputs every monitor signal, such as operation indication, frequency attained and overload indication by the transistor (open collector). Refer to Pr.02-15~02-22 multifunction output terminals for details. Max: +24V/5mA 

B.11 Safety Relay EMVL-SAF01

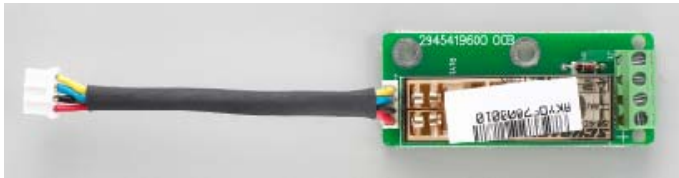

B.11.1 Functions of the Terminals

Terminals	Descriptions	Specifications	
J1	S1	+24VDC power Input	<ul style="list-style-type: none"> • Min. activation voltage: +19Vdc • Impedance: $720+10\% \Omega$ • Rated power: about 800mW
	S2	+24VDC, reference level of the power	
J1	S3	A dry contact of a relay	<ul style="list-style-type: none"> • Rated current: 8 A • Rated voltage/max. switch voltage: 240/400 VAC • Contact material: AgSnO₂ • Contact impedance: <ul style="list-style-type: none"> $\leq 100 \text{ m}\Omega / 1 \text{ A} / 24 \text{ VDC}$ $\leq 20 \text{ }\Omega / 10 \text{ mA} / 5 \text{ VDC}$ • Mechanical endurance: 10×10^6 cycles • Rated operation frequency: $6 \text{ min}^{-1} / 150 \text{ min}^{-1}$ (loaded/unloaded)
	S4	A dry contact of a relay	

B.11.2 Wiring of the Safety Relay

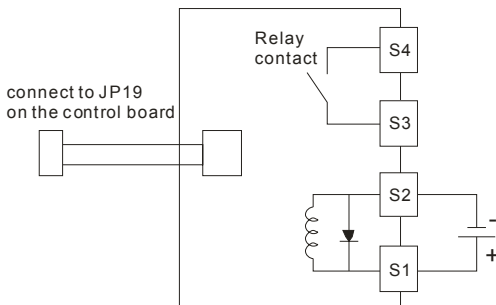

Descriptions

1. When the power +24VDC is applied to S1 and S2 (S1 is +), the relay contacts of S3 and S4 are ON. When the power +24VDC isn't applied to S1 and S2, the relay contacts of S3 and S4 are OFF. At the meanwhile, EMVL-SAF01 can stop the output of the AC motor drive by connecting to JP19 on the control board. It can also be used with MI8 to achieve two safety-loop protections via hardware.
2. Multifunction input MI8
 - (1) Please remove JP1 from the control board before using safety-loop function. At the meanwhile, the multifunction input MI8 can control the output of the AC motor drive.
 - (2) operation method:
MI8 is ON: the AC motor drive can output
MI8 is OFF: the AC motor drive can't output
NOTE: Please insert JP1 into the control board when this function is disabled.
3. Safety-Relay EMVL-SAF01
 - (1) Please connect the power of J3 to JP19 on the control board and remove JP18 on the control board.
 - (2) Operation method:
When the power is applied to S1-S2: It is ON and the AC motor drive can output
When the power isn't applied to S1-S2: it is OFF and the AC motor drive can't output
 - (3) S3-S4 are the monitor contacts and user can check the safety-loop by this contact.



NOTE

- Please notice that when J3 of relay board is connected to JP19 of control board, JP18 must be removed when using EMVL-SAF01.
- Please supply the power +24VDC to S1 and S2 before the AC motor drive is powered on to drive relay.

Appendix C How to Select the Right AC Motor Drive

The choice of the right AC motor drive for the application is very important and has great influence on its lifetime. If the capacity of AC motor drive is too large, it cannot offer complete protection to the motor and motor maybe damaged. If the capacity of AC motor drive is too small, it cannot offer the required performance and the AC motor drive maybe damaged due to overloading.

But by simply selecting the AC motor drive of the same capacity as the motor, user application requirements cannot be met completely. Therefore, a designer should consider all the conditions, including load type, load speed, load characteristic, operation method, rated output, rated speed, power and the change of load capacity. The following table lists the factors you need to consider, depending on your requirements.

Item		Related Specification			
		Speed and torque characteristics	Time ratings	Overload capacity	Starting torque
Load type	Friction load and weight load Liquid (viscous) load Inertia load Load with power transmission	●			●
Load speed and torque characteristics	Constant torque Constant output Decreasing torque Decreasing output	●	●		
Load characteristics	Constant load Shock load Repetitive load High starting torque Low starting torque	●	●	●	●
Continuous operation, Short-time operation Long-time operation at medium/low speeds			●	●	
Maximum output current (instantaneous) Constant output current (continuous)		●		●	
Maximum frequency, Base frequency		●			
Power supply transformer capacity or percentage impedance Voltage fluctuations and unbalance Number of phases, single phase protection Frequency				●	●
Mechanical friction, losses in wiring				●	●
Duty cycle modification			●		

C.1 Capacity Formulas

1. When one AC motor drive operates one motor

The starting capacity should be less than 1.5x rated capacity of AC motor drive

The starting capacity=

$$\frac{k \times N}{973 \times \eta \times \cos \varphi} \left(T_L + \frac{GD^2}{375} \times \frac{N}{t_A} \right) \leq 1.5 \times \text{the_capacity_of_AC_motor_drive(kVA)}$$

2. When one AC motor drive operates more than one motor

2.1 The starting capacity should be less than the rated capacity of AC motor drive

- Acceleration time ≤ 60 seconds

The starting capacity=

$$\frac{k \times N}{\eta \times \cos \varphi} [n_r + n_s(k_s - 1)] = P_{CI} \left[1 + \frac{n_s}{n_r} (k_s - 1) \right] \leq 1.5 \times \text{the_capacity_of_AC_motor_drive(kVA)}$$

- Acceleration time ≥ 60 seconds

The starting capacity=

$$\frac{k \times N}{\eta \times \cos \varphi} [n_r + n_s(k_s - 1)] = P_{CI} \left[1 + \frac{n_s}{n_r} (k_s - 1) \right] \leq \text{the_capacity_of_AC_motor_drive(kVA)}$$

2.2 The current should be less than the rated current of AC motor drive(A)

- Acceleration time ≤ 60 seconds

$$n_r + I_M \left[1 + \frac{n_s}{n_r} (k_s - 1) \right] \leq 1.5 \times \text{the_rated_current_of_AC_motor_drive(A)}$$

- Acceleration time ≥ 60 seconds

$$n_r + I_M \left[1 + \frac{n_s}{n_r} (k_s - 1) \right] \leq \text{the_rated_current_of_AC_motor_drive(A)}$$

2.3 When it is running continuously

- The requirement of load capacity should be less than the capacity of AC motor drive(kVA)

The requirement of load capacity=

$$\frac{k \times P_M}{\eta \times \cos \varphi} \leq \text{the_capacity_of_AC_motor_drive(kVA)}$$

- The motor capacity should be less than the capacity of AC motor drive

$$k \times \sqrt{3} \times V_M \times I_M \times 10^{-3} \leq \text{the_capacity_of_AC_motor_drive(kVA)}$$

- The current should be less than the rated current of AC motor drive(A)

$$k \times I_M \leq \text{the_rated_current_of_AC_motor_drive(A)}$$

Symbol explanation

P_M	: Motor shaft output for load (kW)
η	: Motor efficiency (normally, approx. 0.85)
$\cos \varphi$: Motor power factor (normally, approx. 0.75)
V_M	: Motor rated voltage(V)
I_M	: Motor rated current(A), for commercial power
k	: Correction factor calculated from current distortion factor (1.05-1.1, depending on PWM method)
P_{C1}	: Continuous motor capacity (kVA)
k_s	: Starting current/rated current of motor
n_T	: Number of motors in parallel
n_s	: Number of simultaneously started motors
GD^2	: Total inertia (GD^2) calculated back to motor shaft (kg m^2)
T_L	: Load torque
t_A	: Motor acceleration time
N	: Motor speed

C.2 General Precaution

Selection Note

1. When the AC Motor Drive is connected directly to a large-capacity power transformer (600kVA or above) or when a phase lead capacitor is switched, excess peak currents may occur in the power input circuit and the converter section may be damaged. To avoid this, use an AC input reactor (optional) before AC Motor Drive mains input to reduce the current and improve the input power efficiency.
2. When a special motor is used or more than one motor is driven in parallel with a single AC Motor Drive, select the AC Motor Drive current $\geq 1.25 \times (\text{Sum of the motor rated currents})$.
3. The starting and accel./decel. characteristics of a motor are limited by the rated current and the overload protection of the AC Motor Drive. Compared to running the motor D.O.L. (Direct On-Line), a lower starting torque output with AC Motor Drive can be expected. If higher starting torque is required (such as for elevators, mixers, tooling machines, etc.) use an AC Motor Drive of higher capacity or increase the capacities for both the motor and the AC Motor Drive.
4. When an error occurs on the drive, a protective circuit will be activated and the AC Motor Drive output is turned off. Then the motor will coast to stop. For an emergency stop, an external mechanical brake is needed to quickly stop the motor.

Parameter Settings Note

1. The AC Motor Drive can be driven at an output frequency up to 400Hz (less for some models) with the digital keypad. Setting errors may create a dangerous situation. For safety, the use of the upper limit frequency function is strongly recommended.
2. High DC brake operating voltages and long operation time (at low frequencies) may cause overheating of the motor. In that case, forced external motor cooling is recommended.
3. Motor accel./decel. time is determined by motor rated torque, load torque, and load inertia.
4. If the stall prevention function is activated, the accel./decel. time is automatically extended to a length that the AC Motor Drive can handle. If the motor needs to decelerate within a certain time with high load inertia that can't be handled by the AC Motor Drive in the

required time, either use an external brake resistor and/or brake unit, depending on the model, (to shorten deceleration time only) or increase the capacity for both the motor and the AC Motor Drive.

C.3 How to Choose a Suitable Motor

Standard motor

When using the AC Motor Drive to operate a standard 3-phase induction motor, take the following precautions:

5. The energy loss is greater than for an inverter duty motor.
6. Avoid running motor at low speed for a long time. Under this condition, the motor temperature may rise above the motor rating due to limited airflow produced by the motor's fan. Consider external forced motor cooling.
7. When the standard motor operates at low speed for long time, the output load must be decreased.
8. The load tolerance of a standard motor is as follows:

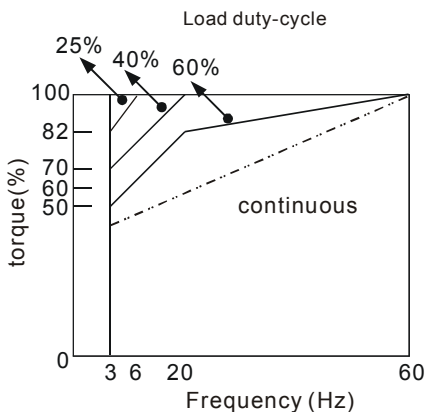

9. If 100% continuous torque is required at low speed, it may be necessary to use a special inverter duty motor.
10. Motor dynamic balance and rotor endurance should be considered once the operating speed exceeds the rated speed (60Hz) of a standard motor.

11. Motor torque characteristics vary when an AC Motor Drive instead of commercial power supply drives the motor. Check the load torque characteristics of the machine to be connected.
12. Because of the high carrier frequency PWM control of the VFD series, pay attention to the following motor vibration problems:
 - Resonant mechanical vibration: anti-vibration (damping) rubbers should be used to mount equipment that runs at varying speed.
 - Motor imbalance: special care is required for operation at 50 or 60 Hz and higher frequency.
 - To avoid resonances, use the Skip frequencies.
13. The motor fan will be very noisy when the motor speed exceeds 50 or 60Hz.

Special motors:

1. Pole-changing (Dahlander) motor:

The rated current is differs from that of a standard motor. Please check before operation and select the capacity of the AC motor drive carefully. When changing the pole number the motor needs to be stopped first. If over current occurs during operation or regenerative voltage is too high, please let the motor free run to stop (coast).
2. Submersible motor:

The rated current is higher than that of a standard motor. Please check before operation and choose the capacity of the AC motor drive carefully. With long motor cable between AC motor drive and motor, available motor torque is reduced.
3. Explosion-proof (Ex) motor:

Needs to be installed in a safe place and the wiring should comply with the (Ex) requirements. Delta AC Motor Drives are not suitable for (Ex) areas with special precautions.
4. Gear reduction motor:

The lubricating method of reduction gearbox and speed range for continuous operation will be different and depending on brand. The lubricating function for operating long time at low speed and for high-speed operation needs to be considered carefully.
5. Synchronous motor:

The rated current and starting current are higher than for standard motors. Please check before operation and choose the capacity of the AC motor drive carefully. When the AC

motor drive operates more than one motor, please pay attention to starting and changing the motor.

Power Transmission Mechanism

Pay attention to reduced lubrication when operating gear reduction motors, gearboxes, belts and chains, etc. over longer periods at low speeds. At high speeds of 50/60Hz and above, lifetime reducing noises and vibrations may occur.

Motor torque

The torque characteristics of a motor operated by an AC motor drive and commercial mains power are different.

Below you'll find the torque-speed characteristics of a standard motor (4-pole, 15kW):

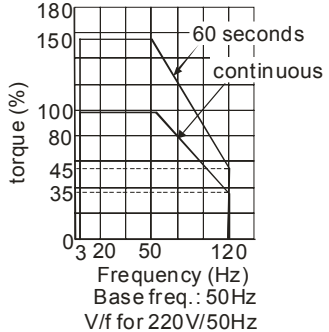
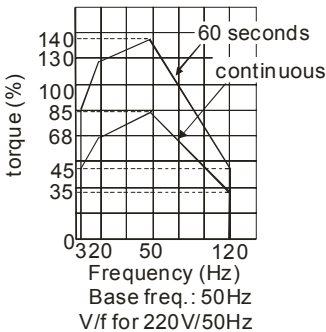
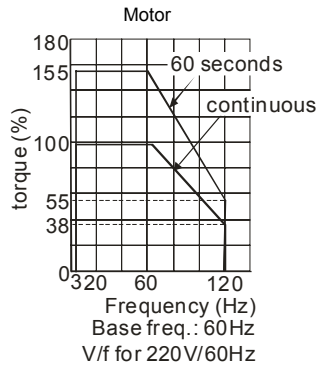
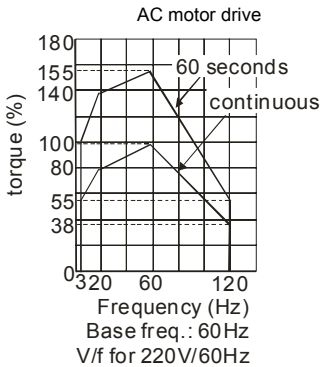

Appendix D Suggestions and Error Corrections for Standard AC Motor Drives

The AC motor drive has a comprehensive fault diagnostic system that includes several different alarms and fault messages. Once a fault is detected, the corresponding protective functions will be activated. The following faults are displayed as shown on the AC motor drive digital keypad display. The six most recent faults can be read from the digital keypad or communication.

The AC motor drive is made up by numerous components, such as electronic components, including IC, resistor, capacity, transistor, and cooling fan, relay, etc. These components can't be used permanently. They have limited-life even under normal operation. Preventive maintenance is required to operate this AC motor drive in its optimal condition, and to ensure a long life.

Basic check-up items to detect if there were any abnormalities during operation are:



- Wait 5 seconds after a fault has been cleared before performing reset via keypad of input terminal.
- When the power is off after 5 minutes for $\leq 22\text{kW}$ models and 10 minutes for $\geq 30\text{kW}$ models, please confirm that the capacitors have fully discharged by measuring the voltage between + and -. The voltage between + and - should be less than 25VDC.
- Only qualified personnel can install, wire and maintain drives. Please take off any metal objects, such as watches and rings, before operation. And only insulated tools are allowed.
- Never reassemble internal components or wiring.
- Make sure that installation environment comply with regulations without abnormal noise, vibration and smell.

D.1 Maintenance and Inspections

Before the check-up, always turn off the AC input power and remove the cover. Wait at least 10 minutes after all display lamps have gone out, and then confirm that the capacitors have fully discharged by measuring the voltage between DC+ and DC-. The voltage between DC+ and DC- should be less than 25VDC.

■ Ambient environment

Check Items	Methods and Criterion	Maintenance Period		
		Daily	Half Year	One Year
Check the ambient temperature, humidity, vibration and see if there are any dust, gas, oil or water drops	Visual inspection and measurement with equipment with standard specification	○		
If there are any dangerous objects	Visual inspection	○		

■ Voltage

Check Items	Methods and Criterion	Maintenance Period		
		Daily	Half Year	One Year
Check if the voltage of main circuit and control circuit is correct	Measure with multimeter with standard specification	○		

■ Keypad

Check Items	Methods and Criterion	Maintenance Period		
		Daily	Half Year	One Year
Is the display clear for reading	Visual inspection	○		
Any missing characters	Visual inspection	○		

■ **Mechanical parts**

Check Items	Methods and Criterion	Maintenance Period		
		Daily	Half Year	One Year
If there is any abnormal sound or vibration	Visual and aural inspection		○	
If there are any loose screws	Tighten the screws		○	
If any part is deformed or damaged	Visual inspection		○	
If there is any color change by overheating	Visual inspection		○	
If there is any dust or dirt	Visual inspection		○	

■ **Main circuit**

Check Items	Methods and Criterion	Maintenance Period		
		Daily	Half Year	One Year
If there are any loose or missing screws	Tighten or replace the screw	○		
If machine or insulator is deformed, cracked, damaged or with color change due to overheating or ageing	Visual inspection NOTE: Please ignore the color change of copper plate		○	
If there is any dust or dirt	Visual inspection		○	

■ **Terminals and wiring of main circuit**

Check Items	Methods and Criterion	Maintenance Period		
		Daily	Half Year	One Year
If the terminal or the plate is color change or deformation due to overheat	Visual inspection		○	
If the insulator of wiring is damaged or color change	Visual inspection		○	
If there is any damage	Visual inspection	○		

■ **DC capacity of main circuit**

Check Items	Methods and Criterion	Maintenance Period		
		Daily	Half Year	One Year
If there is any leak of liquid, color change, crack or deformation	Visual inspection	○		
If the safety valve is not removed? If valve is inflated?	Visual inspection	○		
Measure static capacity when required		○		

■ **Resistor of main circuit**

Check Items	Methods and Criterion	Maintenance Period		
		Daily	Half Year	One Year
If there is any peculiar smell or insulator cracks due to overheat	Visual inspection, smell	○		
If there is any disconnection	Visual inspection	○		
If connection is damaged?	Measure with multimeter with standard specification	○		

■ **Transformer and reactor of main circuit**

Check Items	Methods and Criterion	Maintenance Period		
		Daily	Half Year	One Year
If there is any abnormal vibration or peculiar smell	Visual, aural inspection and smell	○		

■ **Magnetic contactor and relay of main circuit**

Check Items	Methods and Criterion	Maintenance Period		
		Daily	Half Year	One Year
If there are any loose screws	Visual and aural inspection	○		
If the contact works correctly	Visual inspection	○		

■ **Printed circuit board and connector of main circuit**

Check Items	Methods and Criterion	Maintenance Period		
		Daily	Half Year	One Year
If there are any loose screws and connectors	Tighten the screws and press the connectors firmly in place.		○	
If there is any peculiar smell and color change	Visual and smell inspection		○	
If there is any crack, damage, deformation or corrosion	Visual inspection		○	
If there is any liquid is leaked or deformation in capacity	Visual inspection		○	

■ **Cooling fan of cooling system**

Check Items	Methods and Criterion	Maintenance Period		
		Daily	Half Year	One Year
If there is any abnormal sound or vibration	Visual, aural inspection and turn the fan with hand (turn off the power before operation) to see if it rotates smoothly		○	
If there is any loose screw	Tighten the screw		○	
If there is any color change due to overheat	Change fan		○	

■ Ventilation channel of cooling system

Check Items	Methods and Criterion	Maintenance Period		
		Daily	Half Year	One Year
If there is any obstruction in the heat sink, air intake or air outlet	Visual inspection		○	

 **NOTE**

Please use the neutral cloth for clean and use dust cleaner to remove dust when necessary.

D.2 Greasy Dirt Problem

Serious greasy dirt problems generally occur in processing industries such as machine tools, punching machines and so on. Please be aware of the possible damages that greasy oil may cause to your drive:

1. Electronic components that silt up with greasy oil may cause the drive to burn out or even explode.
2. Most greasy dirt contains corrosive substances that may damage the drive.

Solutions:

Install the AC motor drive in a standard cabinet to keep it away from dirt. Clean and remove greasy dirt regularly to prevent damage to the drive.

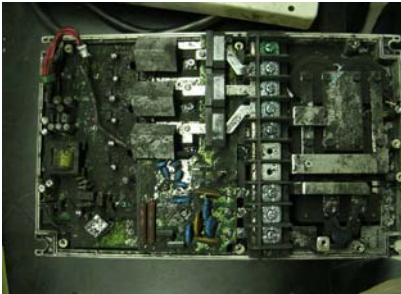

D.3 Fiber Dust Problem

Serious fiber dust problems generally occur in the textile industry. Please be aware of the possible damages that fiber may cause to your drives:

1. Fiber that accumulates or adheres to the fans will lead to poor ventilation and cause overheating problems.
2. Plant environments in the textile industry have higher degrees of humidity that may cause the drive to burn out, become damaged or explode due to wet fiber dust adhering to the devices.

Solutions:

Install the AC motor drive in a standard cabinet to keep it away from fiber dust. Clean and remove fiber dust regularly to prevent damage to the drive.



D.4 Erosion Problem

Erosion problems may occur if any fluids flow into the drives. Please be aware of the damages that erosion may cause to your drive.

1. Erosion of internal components may cause the drive to malfunction and possibility to explode.

Solutions:

Install the AC motor drive in a standard cabinet to keep it away from fluids. Clean the drive regularly to prevent erosion.

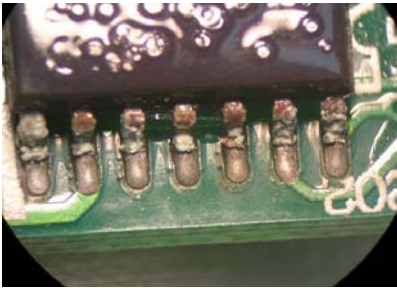

D.5 Industrial Dust Problem

Serious industrial dust pollution frequently occurs in stone processing plants, flour mills, cement plants, and so on. Please be aware of the possible damage that industrial dust may cause to your drives:

1. Dust accumulating on electronic components may cause overheating problem and shorten the service life of the drive.
2. Conductive dust may damage the circuit board and may even cause the drive to explode.

Solutions: Install the AC motor drive in a standard cabinet and cover the drive with a dust cover. Clean the cabinet and ventilation hole regularly for good ventilation.

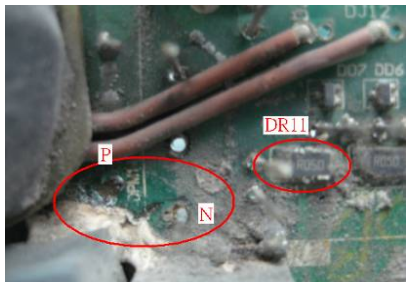

D.6 Wiring and Installation Problem

When wiring the drive, the most common problem is wrong wire installation or poor wiring. Please be aware of the possible damages that poor wiring may cause to your drives:

1. Screws are not fully fastened. Occurrence of sparks as impedance increases.
2. If a customer has opened the drive and modified the internal circuit board, the internal components may have been damaged.

Solutions: Ensure all screws are fastened when installing the AC motor drive. If the AC motor drive functions abnormally, send it back to the repair station. DO NOT try to reassemble the internal components or wire.

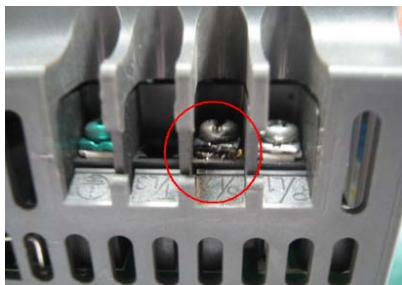

D.7 Multi-function Input/Output Terminals Problem

Multi-function input/output terminal errors are generally caused by over usage of terminals and not following specifications. Please be aware of the possible damages that errors on multi-function input/output terminals may cause to your drives:

1. Input/output circuit may burn out when the terminal usage exceeds its limit.

Solutions: Refer to the user manual for multi-function input output terminals usage and follow the specified voltage and current. DO NOT exceed the specification limits.

